

# EMI Suppression Filters (for DC)/ Chip Inductors for Automotive

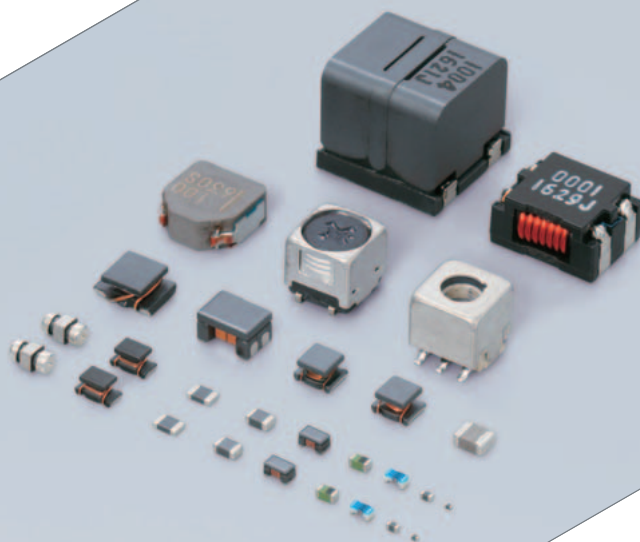

## Explanation of category in this catalog

### Infotainment

Info-  
tainment

The product for entertainment equipment like car navigations, car audios, and body control equipment like wipers, power windows.

### Powertrain, Safety

Power-  
train

The product for high reliability applications like powertrain and safety, in addition to infotainment applications.

### EU RoHS Compliant

- All the products in this catalog comply with EU RoHS.
- EU RoHS is "the European Directive 2011/65/EU on the Restriction of the Use of Certain Hazardous Substances in Electrical and Electronic Equipment."
- For more details, please refer to our web page, "Murata's Approach for EU RoHS" (<https://www.murata.com/en-eu/support/compliance/rohs>).

Because of the difference of measurement condition, electrical characteristics plots on this catalog may have some difference to official specification value.



# Contents

Product specifications are as of May 2021.

## EMI Suppression Filters (for DC)

Product Guide ..... p2

### Chip Ferrite Bead

Part Numbering ..... p5  
Product Detail ..... p6  
⚠Caution/Notice ..... p120

### Chip EMIFIL

Part Numbering ..... p122  
Product Detail ..... p124  
⚠Caution/Notice ..... p141

### Chip Common Mode Choke Coil

Part Numbering ..... p143  
Product Detail ..... p146  
⚠Caution/Notice ..... p169

### Block Type EMIFIL

Product Detail (SMD Type) ..... p174  
⚠Caution/Notice (SMD Type) ..... p176  
Product Detail (Lead Type) ..... p178  
⚠Caution/Notice (Lead Type) ..... p180

### Microchip Transformer (Balun)

Part Numbering ..... p182  
Product Detail ..... p183  
⚠Caution/Notice ..... p185

## Chip Inductors

Product Guide ..... p187

### Inductors for Power Lines

Part Numbering ..... p189  
Product Detail ..... p191  
⚠Caution/Notice ..... p270

### Inductors for General Circuits

Part Numbering ..... p274  
Product Detail ..... p275  
⚠Caution/Notice ..... p284

### RF Inductors

















































































Part Numbering ..... p288  
Product Detail ..... p289  
⚠Caution/Notice ..... p338

Part Number Quick Reference ..... p341

Please check the MURATA website (<https://www.murata.com/>) if you cannot find a part number in this catalog.

# Product Guide

## BL Inductor Type

		Part Number/Series	Applications	Size Code in mm (in inch)	Impedance at 100MHz	
For General Band Noise	Universal Type [ Power Lines / Signal Lines ]	BLM03AX p9		0603 (0201)	10Ω to 1000Ω	
		BLM15AX p28		1005 (0402)	10Ω to 1000Ω	
	Signal Lines Type	For General Signal Lines	BLM03AG p10		0603 (0201)	10Ω to 1000Ω
			BLM15AG p30	 	1005 (0402)	10Ω to 1000Ω
			BLM18AG p66	 	1608 (0603)	120Ω to 1000Ω
			BLM18AG* (150°C available) p68		1608 (0603)	120Ω to 1000Ω
			BLM18AG* (Conductive glue) p70		1608 (0603)	470Ω to 1000Ω
		BLM21AG p99	 	2012 (0805)	120Ω to 1000Ω	
		BLM21AG* (150°C available) p101		2012 (0805)	120Ω to 1000Ω	
		BLM31AJ p114		3216 (1206)	600Ω	
		For High Speed Signal Lines	BLM03B p12		0603 (0201)	10Ω to 600Ω
			BLM15B p31	 	1005 (0402)	5Ω to 1800Ω
	BLM18B p72		 	1608 (0603)	5Ω to 2500Ω	
	BLM18B* (150°C available) p77			1608 (0603)	47Ω to 2500Ω	
	BLM21B p103		 	2012 (0805)	5Ω to 2700Ω	
	Power Lines Type	BLM03PX* p7		0603 (0201)	22Ω to 120Ω	
		BLM03PG p6		0603 (0201)	22Ω to 33Ω	
		BLM15PX* p26		1005 (0402)	33Ω to 600Ω	
		BLM15PE* p23		1005 (0402)	30Ω to 600Ω	
		BLM15PG/PD* p21		1005 (0402)	10Ω to 120Ω	
		BLM18PG* p50	 	1608 (0603)	30Ω to 470Ω	
		BLM21PG* p90	 	2012 (0805)	22Ω to 330Ω	
		BLM21PG* (150°C available) p92		2012 (0805)	22Ω to 330Ω	
		BLM31PG* p107	 	3216 (1206)	33Ω to 600Ω	
		BLM41PG* p115	 	4516 (1806)	60Ω to 1000Ω	
		BLM18KG* (Low DC Resistance Type) p57	 	1608 (0603)	26Ω to 1000Ω	
		BLM18KG* (150°C available) p59		1608 (0603)	26Ω to 1000Ω	
		BLM18KG* (Conductive glue) p62		1608 (0603)	26Ω to 1000Ω	
		BLM18KN* (175°C available) p64		1608 (0603)	26Ω to 1000Ω	
		BLM31KN* p109	 	3216 (1206)	120Ω to 1000Ω	
		BLM31KN* (150°C available) p111		3216 (1206)	120Ω to 1000Ω	
		BLM18SG* (Low DC Resistance Type) p52		1608 (0603)	26Ω to 330Ω	
		BLM18SN* p54	 	1608 (0603)	22Ω	
		BLM18SP* (Low DC Resistance Type) p55	 	1608 (0603)	30Ω to 1000Ω	
		BLM21SN* p94	 	2012 (0805)	30Ω	
BLM21SP* (Low DC Resistance Type) p95		 	2012 (0805)	70Ω to 1000Ω		
BLM21SP* (150°C available) p97			2012 (0805)	70Ω to 1000Ω		
BLM31SN* p113		 	3216 (1206)	50Ω		
BLE18PS* p117		 	1608 (0603)	8.5Ω		
BLE18PS* (150°C available) p118			1608 (0603)	8.5Ω		
BLE32PN p119		 	3225 (1210)	26Ω to 30Ω		
For GHz Band Noise		Universal Type [ Power Lines / Signal Lines ]	BLM03EB* p19	 	0603 (0201)	25Ω to 50Ω
			BLM15EG* p46	 	1005 (0402)	120Ω to 220Ω
	BLM18EG* p87		 	1608 (0603)	100Ω to 600Ω	
	Signal Lines Type	BLM18HE* p84	 	1608 (0603)	600Ω to 1500Ω	
		BLM03HG p18	 	0603 (0201)	600Ω to 1200Ω	
		BLM03HD p16		0603 (0201)	330Ω to 1800Ω	
		BLM03HB p15		0603 (0201)	190Ω to 400Ω	
		BLM15HG p43	 	1005 (0402)	600Ω to 1000Ω	
		BLM15HG* (150°C available) p44		1005 (0402)	600Ω to 1000Ω	
		BLM15HD p40	 	1005 (0402)	600Ω to 1800Ω	
		BLM15HD* (150°C available) p41		1005 (0402)	600Ω to 1800Ω	
		BLM15HB p39	 	1005 (0402)	120Ω to 220Ω	

\* The derating of rated current is required for some items according to the operating temperature on each product page.

Continued from the preceding page. ↘

		Part Number/Series	Applications	Size Code in mm (in inch)	Impedance at 100MHz
For GHz Band Noise	Signal Lines Type	<b>BLM18HG</b> p86	<a href="#">Info-tainment</a> <a href="#">Power-train</a>	1608 (0603)	470Ω to 1000Ω
		<b>BLM18HD</b> p83	<a href="#">Info-tainment</a> <a href="#">Power-train</a>	1608 (0603)	470Ω to 1000Ω
		<b>BLM18HB</b> p82	<a href="#">Info-tainment</a>	1608 (0603)	120Ω to 330Ω
For High-GHz Band Noise	Signal Lines Type	<b>BLM15GG</b> p49	<a href="#">Info-tainment</a>	1005 (0402)	220Ω to 470Ω
		<b>BLM15GA</b> p48	<a href="#">Info-tainment</a>	1005 (0402)	75Ω
		<b>BLM18GG</b> p89	<a href="#">Info-tainment</a>	1608 (0603)	470Ω
	Universal Type [ Power Lines / Signal Lines ]	<b>BLM18DN*</b> p80	<a href="#">Info-tainment</a> <a href="#">Power-train</a>	1608 (0603)	150Ω to 600Ω

\* The derating of rated current is required for some items according to the operating temperature on each product page.

Frequency Specified Noise Filter	Part Number/Series	Applications	Size Code in mm (in inch)	Target Frequency	Rated Current (mA)
Universal Type [ Power Lines / Signal Lines ]	<b>BLF03JD*</b> p140	<a href="#">Info-tainment</a>	0603 (0201)	700MHz	480

\* The derating of rated current is required for some items according to the operating temperature on each product page.

## NF □

Combined Type

	Part Number/Series	Applications	Size Code in mm (in inch)	Cut-off Frequency
Signal Lines Type	<b>NFL18ZT</b> p126	<a href="#">Info-tainment</a>	1608 (0603)	50MHz to 500MHz

Combined Type

	Part Number/Series	Applications	Size Code in mm (in inch)	Capacitance
Universal Type [ Power Lines / Signal Lines ]	<b>NFE31ZT</b> p124	<a href="#">Info-tainment</a>	3216 (1206)	22pF to 2200pF
	<b>NFE61HT</b> p125	<a href="#">Info-tainment</a> <a href="#">Power-train</a>	6816 (2706)	33pF to 3300pF

Inductor Type

	Part Number/Series	Applications	Size Code in mm (in inch)	Impedance at 1MHz
For LED Lines	<b>NFZ32BW*</b> p132	<a href="#">Info-tainment</a>	3225 (1210)	3.3Ω to 880Ω
	<b>NFZ5BBW*</b> p137	<a href="#">Info-tainment</a>	5050 (2020)	2.9Ω to 140Ω

\* The derating of rated current is required for some items according to the operating temperature on each product page.

Inductor Type

	Part Number/Series	Applications	Size Code in mm (in inch)	Impedance at 100MHz
For Audio Lines	<b>NFZ15SF</b> p127	<a href="#">Info-tainment</a>	1005 (0402)	1000Ω
	<b>NFZ18SM*</b> p128	<a href="#">Info-tainment</a>	1608 (0603)	120Ω to 700Ω
	<b>NFZ2MSD*</b> p130	<a href="#">Info-tainment</a>	2016 (0806)	100Ω to 1000Ω

\* The derating of rated current is required for some items according to the operating temperature on each product page.

## DL

Common Mode Choke Coils

	Part Number/Series	Applications	Size Code in mm (in inch)	Common Mode Impedance at 100MHz	Common Mode Inductance at 0.1MHz	Common Mode Inductance at 1MHz
For Power Lines	<b>DLW5AT*</b> p157	<a href="#">Info-tainment</a> <a href="#">Power-train</a>	5036 (2014)	45Ω to 1100Ω	-	-
	<b>DLW5BT*</b> p162	<a href="#">Info-tainment</a> <a href="#">Power-train</a>	5050 (2020)	100Ω to 1400Ω	-	-
	<b>DLW5BS</b> p161	<a href="#">Info-tainment</a>	5050 (2020)	500Ω to 800Ω	-	-
	<b>UCMH0907</b> p168 (Part Number: 1259CM-0001)	<a href="#">Info-tainment</a>	9070 (3527)	700Ω	-	-
USB, HDMI, and LVDS, etc.	<b>DLM11SN_HZ2</b> p146	<a href="#">Info-tainment</a>	1210 (0504)	45Ω to 90Ω	-	-
	<b>DLW21SZ_HQ2</b> p147	<a href="#">Info-tainment</a>	2012 (0805)	67Ω to 120Ω	-	-
	<b>DLW21SZ_XQ2</b> p148	<a href="#">Info-tainment</a>	2012 (0805)	180Ω to 490Ω	-	-
	<b>DLW31SH_SQ2</b> p151	<a href="#">Power-train</a>	3216 (1206)	2200Ω	-	-
SerDes (PoC)	<b>DLW21SH391XQ2*</b> p149	<a href="#">Power-train</a>	2012 (0805)	390Ω	-	-
	<b>DLW21PH201XQ2*</b> p150	<a href="#">Power-train</a>	2012 (0805)	200Ω	-	-
CAN/FlexRay	<b>DLW43SH110XK2</b> p156	<a href="#">Power-train</a>	4532 (1812)	-	11μH	-
	<b>DLW43SH220XK2</b> p156	<a href="#">Power-train</a>	4532 (1812)	-	22μH	-
	<b>DLW43SH510XK2</b> p156	<a href="#">Power-train</a>	4532 (1812)	-	-	51μH
	<b>DLW43SH101XK2</b> p156	<a href="#">Power-train</a>	4532 (1812)	-	-	100μH
CAN/CAN FD	<b>DLW32SH101XF2</b> p154	<a href="#">Power-train</a>	3225 (1210)	-	100μH	-
In-vehicle Ethernet (100 Mbps)	<b>DLW32MH_XK2</b> p152	<a href="#">Power-train</a>	3225 (1210)	-	100μH to 200μH	-
	<b>DLW43MH_XK2</b> p155	<a href="#">Power-train</a>	4532 (1812)	-	200μH	-
In-vehicle Ethernet (1000 Mbps)	<b>DLW32MH_XT2</b> p153	<a href="#">Power-train</a>	3225 (1210)	-	80μH to 100μH	-

\* The derating of rated current is required for some items according to the operating temperature on each product page.

## PL

Large Current Common Mode Choke Coil for Automotive Available

	Part Number/Series	Applications	Size Code in mm (in inch)	Common Mode Impedance at 10MHz
Power Lines Type	<b>PLT10H*</b> p166	<a href="#">Power-train</a>	-	45Ω to 1000Ω
	<b>PLT5BP*</b> p164	<a href="#">Power-train</a>	5050 (2020)	100Ω to 500Ω

\* The derating of rated current is required for some items according to the operating temperature on each product page.

## BNX

Block EMIFIL

	Part Number/Series	Applications	Height (mm)	Rated Voltage (Vdc)	Rated Current (A)	
Power Lines Type	SMD Type	<b>BNX024H01*</b> p174	<a href="#">Power-train</a>	3.5	50	20
		<b>BNX025H01*</b> p174	<a href="#">Power-train</a>	3.5	25	20
		<b>BNX026H01*</b> p174	<a href="#">Power-train</a>	3.5	50	20
		<b>BNX027H01*</b> p174	<a href="#">Power-train</a>	3.5	16	20
	Lead Type	<b>BNX012H01*</b> p178	<a href="#">Power-train</a>	8.5 max.	50	15

\* The derating of rated current is required for some items according to the operating temperature on each product page.

● Part Numbering

Chip Ferrite Bead for Automotive

(Part Number) 

BL	M	18	AG	102	S	Z	1	D
①	②	③	④	⑤	⑥	⑦	⑧	⑨

① Product ID

Product ID	
BL	Chip Ferrite Beads

② Type

Code	Type
E	DC Bias Characteristics Improved Type
M	Ferrite Bead Single Type

③ Dimensions (LxW)

Code	Dimensions (LxW)	Size Code (inch)
03	0.6x0.3mm	0201
15	1.0x0.5mm	0402
18	1.6x0.8mm	0603
21	2.0x1.25mm	0805
31	3.2x1.6mm	1206
32	3.2x2.5mm	1210
41	4.5x1.6mm	1806

④ Characteristics/Applications

Code *1	Characteristics/Applications
AG	For General Use
AJ	
AX	
BA	
BB	For High-speed Signal Lines
BC	
BD	
BX	
KG	
KN	
PD	For Power Lines
PE	
PG	
PN	
PS	
PX	
SG	
SN	
SP	
HG	
EB	For GHz Band High-speed Signal Lines (Low Direct Current Type)
EG	For GHz Band General Use (Low DC Resistance Type)
HB	For GHz Band High-speed Signal Lines
HD	
HE	
GA	For High-GHz Band High-speed Signal Lines
GG	For High-GHz Band General Use
DN	For High-GHz Band General Use (Low Direct Current Type)

\*1 Frequency characteristics vary with each code.

⑤ Impedance

Expressed by three figures. The unit is in ohm ( $\Omega$ ) at 100MHz. The first and second figures are significant digits, and the third figure expresses the number of zeros that follow the two figures.

⑥ Electrode

Expressed by a letter.

Ex.)

Code	Electrode
S/F/T/B/J/E	Sn Plating
A	Au Plating
W	Ag/Pd

⑦ Category

Code	Category	
Z	For Automotive	Infotainment
H		Powertrain, Safety

⑧ Number of Circuits

Code	Number of Circuits
1	1 Circuit

⑨ Packaging

Code	Packaging
K	Embossed Taping ( $\varnothing$ 330mm Reel)
L	Embossed Taping ( $\varnothing$ 180mm Reel)
B	Bulk
J	Paper Taping ( $\varnothing$ 330mm Reel)
D	Paper Taping ( $\varnothing$ 180mm Reel)

# Chip Ferrite Bead SMD Type

## BLM03PG Series 0201/0603(inch/mm)

### Specifications Sheet (with cautions/mounting/packaging)

Infotainment	<a href="https://www.murata.com/products/productdata/8796200435742/QNFA9126.pdf?1615959120000">https://www.murata.com/products/productdata/8796200435742/QNFA9126.pdf?1615959120000</a>
Powertrain/Safety	—

### Appearance/Dimensions

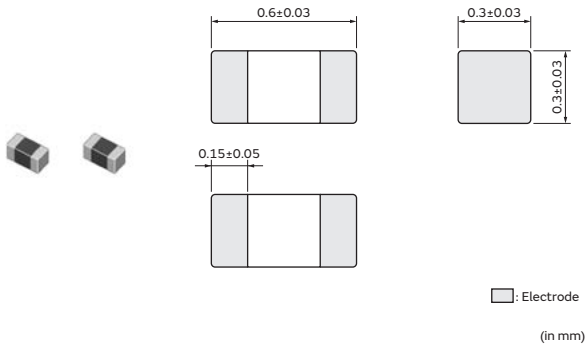

### Packaging

Code	Packaging	Minimum Quantity
D	ø180mm Paper Tape	15000
J	ø330mm Paper Tape	50000
B	Bulk(Bag)	1000

### Equivalent Circuit



(Resistance element becomes dominant at high frequencies.)

### Rated Value (□: packaging code)

Part Number		Impedance at 100MHz	Rated Current at 85°C	Rated Current at 125°C	DC Resistance (Max.)
Infotainment	Powertrain/Safety				
BLM03PG220SZ1□	—	22Ω±25%	900mA	900mA	0.065Ω
BLM03PG330SZ1□	—	33Ω±25%	750mA	750mA	0.09Ω

Operating Temp. Range: -55°C to 125°C

### Z-f characteristics

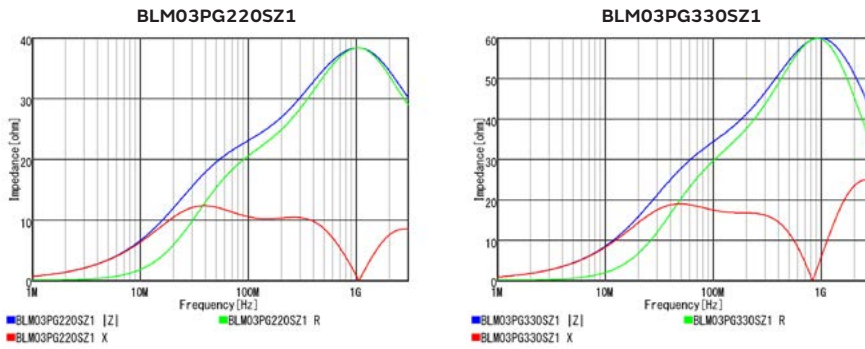

# Chip Ferrite Bead SMD Type

## BLM03PX Series 0201/0603(inch/mm)

### Specifications Sheet (with cautions/mounting/packaging)

Infotainment	<a href="https://www.murata.com/products/productdata/8796200435742/QNFA9126.pdf?1615959120000">https://www.murata.com/products/productdata/8796200435742/QNFA9126.pdf?1615959120000</a>
Powertrain/Safety	—

### Appearance/Dimensions

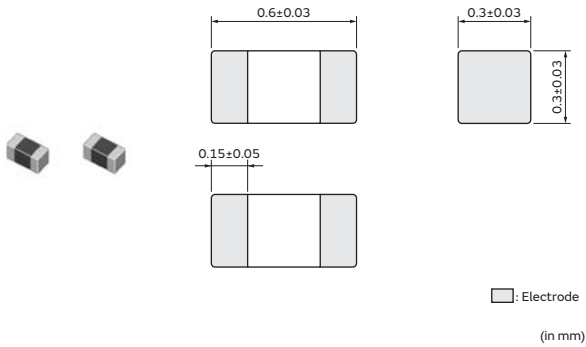

### Packaging

Code	Packaging	Minimum Quantity
D	ø180mm Paper Tape	15000
J	ø330mm Paper Tape	50000
B	Bulk(Bag)	1000

### Equivalent Circuit



(Resistance element becomes dominant at high frequencies.)

### Rated Value (□: packaging code)

Part Number		Impedance at 100MHz	Rated Current at 85°C	Rated Current at 125°C	DC Resistance (Max.)
Infotainment	Powertrain/Safety				
BLM03PX220SZ1□	—	22Ω±25%	1.8A	1.45A	0.04Ω
BLM03PX330SZ1□	—	33Ω±25%	1.5A	1.2A	0.055Ω
BLM03PX800SZ1□	—	80Ω±25%	1A	800mA	0.13Ω
BLM03PX121SZ1□	—	120Ω±25%	900mA	700mA	0.16Ω

Operating Temp. Range: -55°C to 125°C

### Z-f characteristics

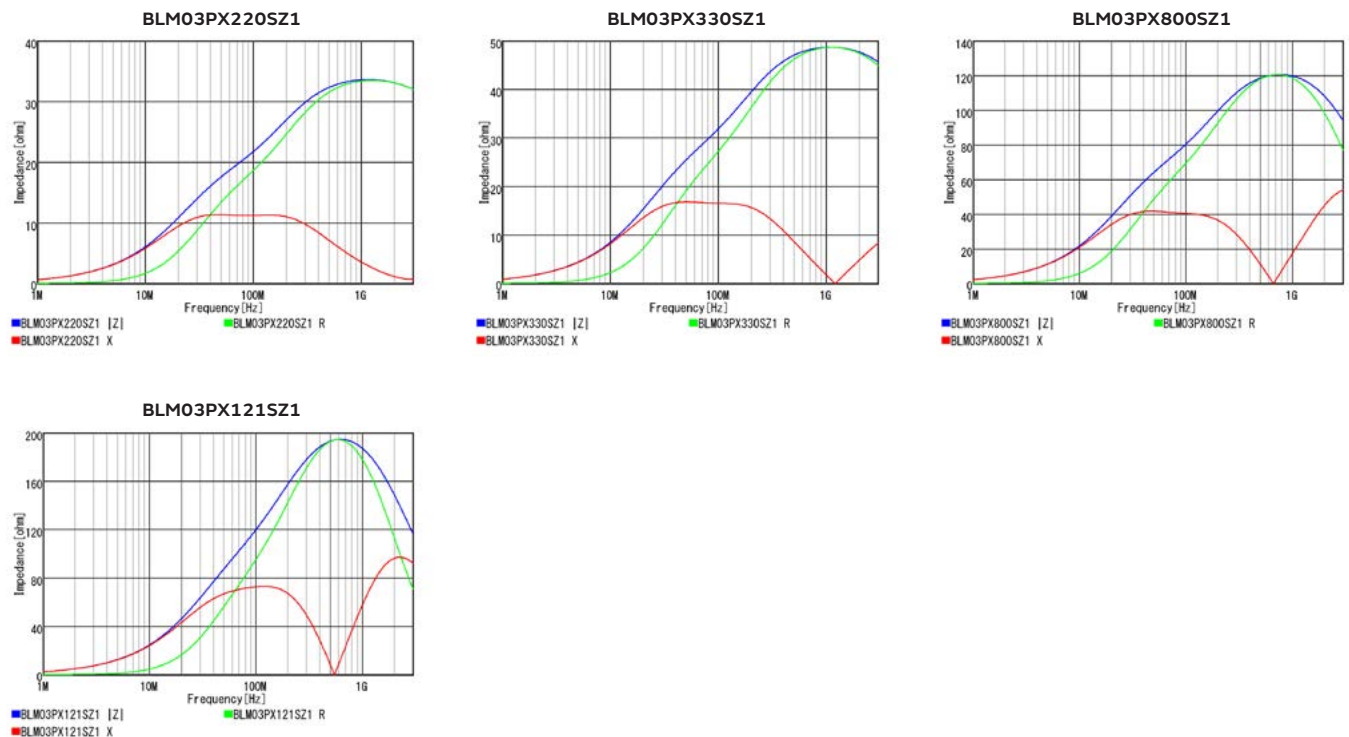

Continued on the following page. ↗

Continued from the preceding page. ↘

## Derating of Rated Current

In operating temperature exceeding +85°C, derating of current is necessary for BLM03PX\_S□1 series.  
Please apply the derating curve shown in chart according to the operating temperature.

Derating of Rated Current

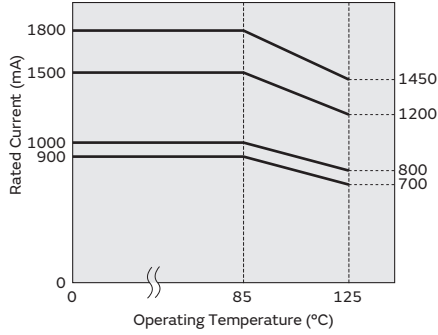

Chip Ferrite Bead

Chip EMIFIL

Chip Common Mode Choke Coil

Block Type EMIFIL

Microchip Transformer (Balun)

Inductors for Power Lines

Inductors for General Circuits

RF Inductors



# Chip Ferrite Bead SMD Type

## BLM03AX Series 0201/0603(inch/mm)

### Specifications Sheet (with cautions/mounting/packaging)

Infotainment	<a href="https://www.murata.com/products/productdata/8796200435742/QNFA9126.pdf?1615959120000">https://www.murata.com/products/productdata/8796200435742/QNFA9126.pdf?1615959120000</a>
Powertrain/Safety	—

### Appearance/Dimensions

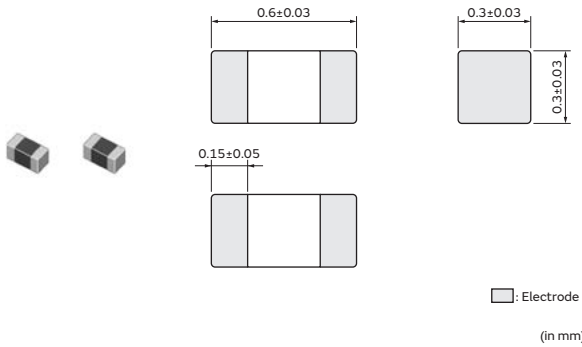

### Packaging

Code	Packaging	Minimum Quantity
D	ø180mm Paper Tape	15000
J	ø330mm Paper Tape	50000
B	Bulk(Bag)	1000

### Equivalent Circuit



(Resistance element becomes dominant at high frequencies.)

### Rated Value (□: packaging code)

Part Number		Impedance at 100MHz	Rated Current at 85°C	Rated Current at 125°C	DC Resistance (Max.)
Infotainment	Powertrain/Safety				
BLM03AX100SZ1□	—	10Ω(Typ.)	1A	1A	0.05Ω
BLM03AX800SZ1□	—	80Ω±25%	500mA	500mA	0.18Ω
BLM03AX121SZ1□	—	120Ω±25%	450mA	450mA	0.23Ω
BLM03AX241SZ1□	—	240Ω±25%	350mA	350mA	0.38Ω
BLM03AX601SZ1□	—	600Ω±25%	250mA	250mA	0.85Ω
BLM03AX102SZ1□	—	1000Ω±25%	200mA	200mA	1.25Ω

Operating Temp. Range: -55°C to 125°C

### Z-f characteristics

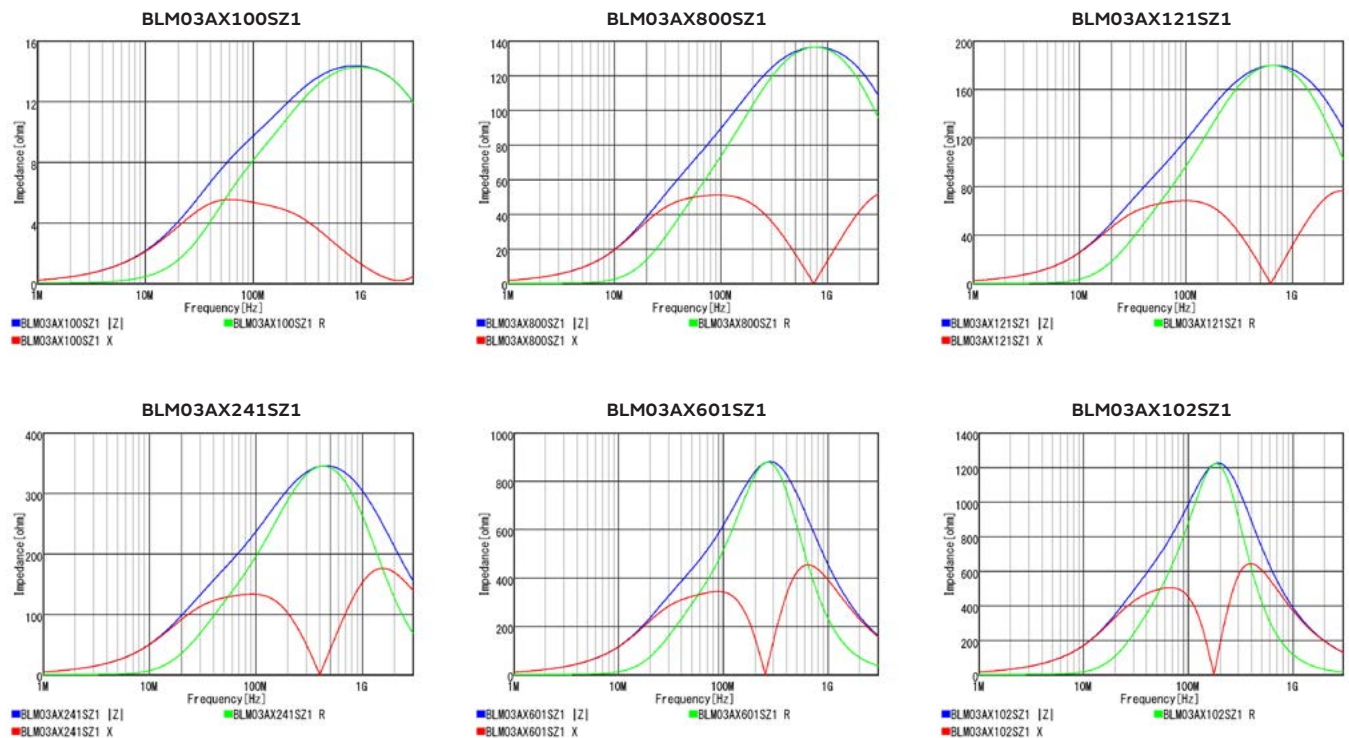

# Chip Ferrite Bead SMD Type

## BLM03AG Series 0201/0603(inch/mm)

### Specifications Sheet (with cautions/mounting/packaging)

Infotainment	<a href="https://www.murata.com/products/productdata/8796200435742/QNFA9126.pdf?1615959120000">https://www.murata.com/products/productdata/8796200435742/QNFA9126.pdf?1615959120000</a>
Powertrain/Safety	—

### Appearance/Dimensions

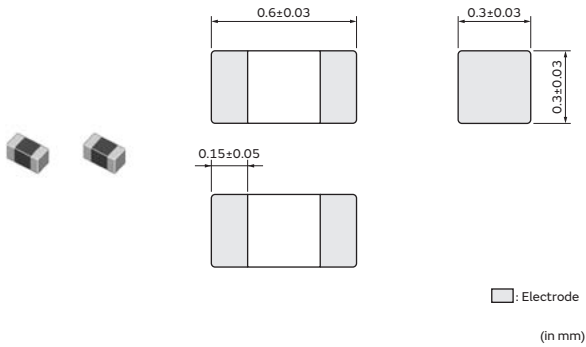

### Packaging

Code	Packaging	Minimum Quantity
D	ø180mm Paper Tape	15000
J	ø330mm Paper Tape	50000
B	Bulk(Bag)	1000

### Equivalent Circuit



(Resistance element becomes dominant at high frequencies.)

### Rated Value (□: packaging code)

Part Number		Impedance at 100MHz	Rated Current at 85°C	Rated Current at 125°C	DC Resistance (Max.)
Infotainment	Powertrain/Safety				
BLM03AG100SZ1□	—	10Ω(Typ.)	500mA	500mA	0.1Ω
BLM03AG700SZ1□	—	70Ω(Typ.)	200mA	200mA	0.4Ω
BLM03AG800SZ1□	—	80Ω±25%	200mA	200mA	0.4Ω
BLM03AG121SZ1□	—	120Ω±25%	200mA	200mA	0.5Ω
BLM03AG241SZ1□	—	240Ω±25%	200mA	200mA	0.8Ω
BLM03AG601SZ1□	—	600Ω±25%	100mA	100mA	1.5Ω
BLM03AG102SZ1□	—	1000Ω±25%	100mA	100mA	2.5Ω

Operating Temp. Range: -55°C to 125°C

### Z-f characteristics

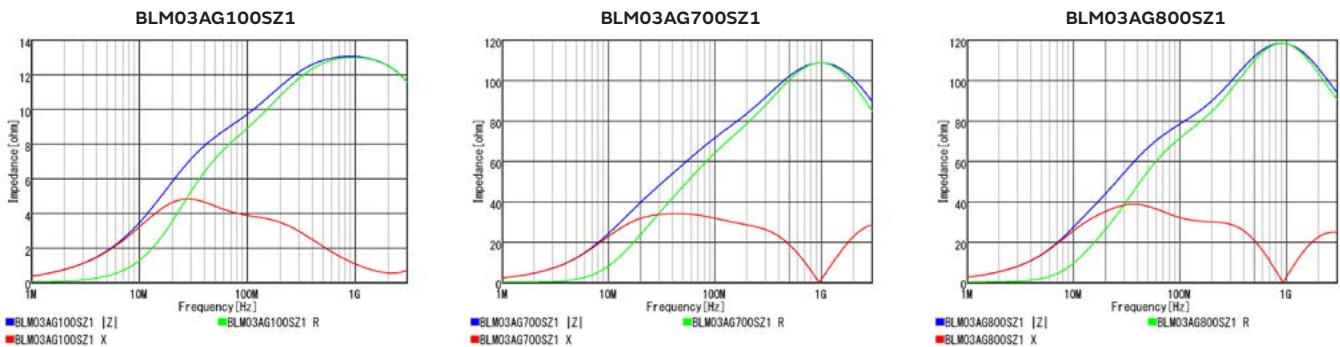

Continued on the following page. ↗

Continued from the preceding page. ↘

## Z-f characteristics

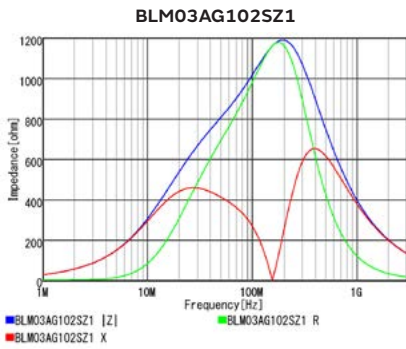
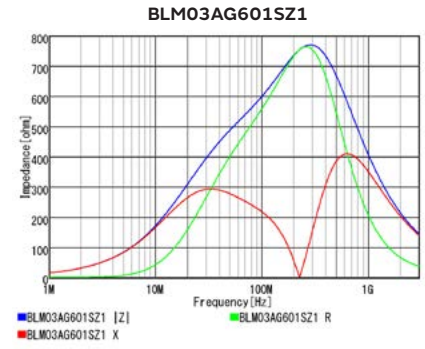
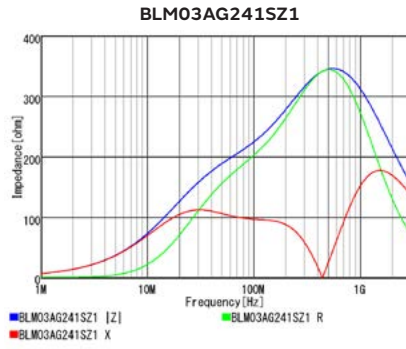
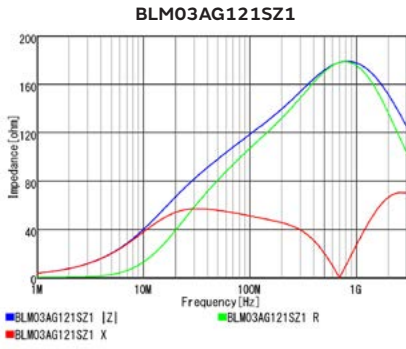

Chip Ferrite Bead

Chip EMI FIL

Chip Common Mode Choke Coil

Block Type EMI FIL

Microchip Transformer (Balun)

Inductors for Power Lines

Inductors for General Circuits

RF Inductors

# Chip Ferrite Bead SMD Type

## BLM03BB Series 0201/0603(inch/mm)

### Specifications Sheet (with cautions/mounting/packaging)

Infotainment	<a href="https://www.murata.com/products/productdata/8796200435742/QNFA9126.pdf?1615959120000">https://www.murata.com/products/productdata/8796200435742/QNFA9126.pdf?1615959120000</a>
Powertrain/Safety	—

### Appearance/Dimensions

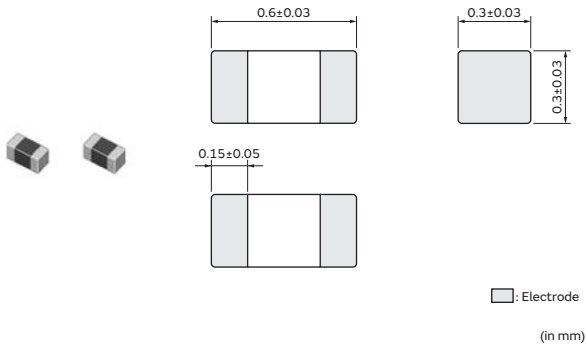

### Packaging

Code	Packaging	Minimum Quantity
D	ø180mm Paper Tape	15000
J	ø330mm Paper Tape	50000
B	Bulk(Bag)	1000

### Equivalent Circuit



(Resistance element becomes dominant at high frequencies.)

### Rated Value (□: packaging code)

Part Number		Impedance at 100MHz	Rated Current at 85°C	Rated Current at 125°C	DC Resistance (Max.)
Infotainment	Powertrain/Safety				
BLM03BB100SZ1□	—	10Ω±25%	300mA	300mA	0.4Ω
BLM03BB220SZ1□	—	22Ω±25%	200mA	200mA	0.5Ω
BLM03BB470SZ1□	—	47Ω±25%	200mA	200mA	0.7Ω
BLM03BB750SZ1□	—	75Ω±25%	200mA	200mA	1Ω
BLM03BB121SZ1□	—	120Ω±25%	100mA	100mA	1.5Ω

Operating Temp. Range: -55°C to 125°C

### Z-f characteristics

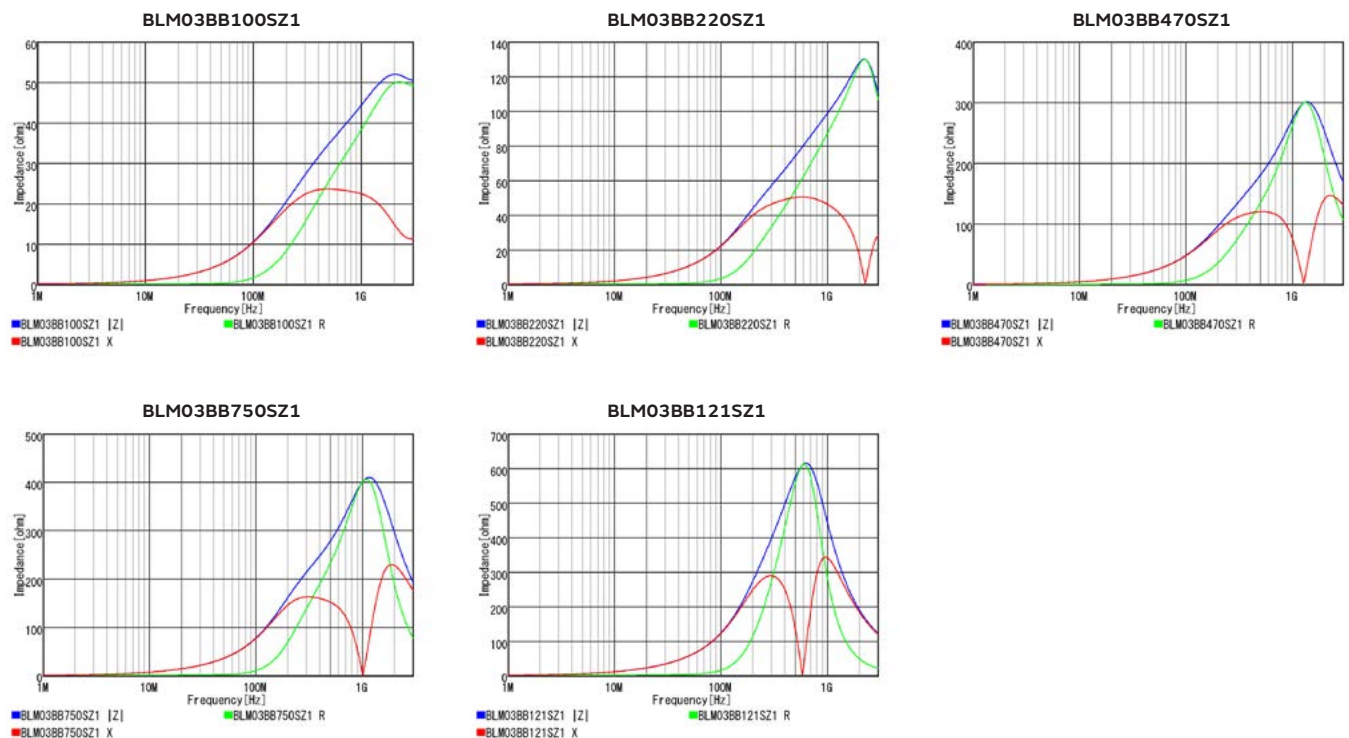

# Chip Ferrite Bead SMD Type

## BLM03BC Series 0201/0603(inch/mm)

### Specifications Sheet (with cautions/mounting/packaging)

Infotainment	<a href="https://www.murata.com/products/productdata/8796200435742/QNFA9126.pdf?1615959120000">https://www.murata.com/products/productdata/8796200435742/QNFA9126.pdf?1615959120000</a>
Powertrain/Safety	—

### Appearance/Dimensions

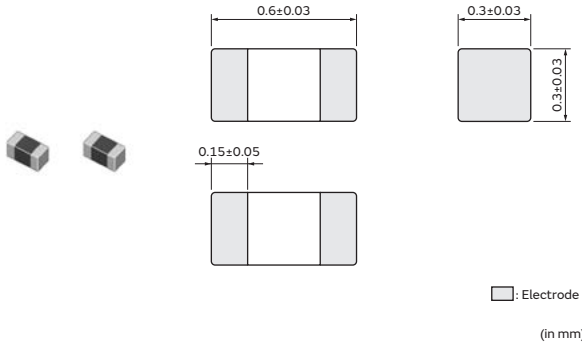

### Packaging

Code	Packaging	Minimum Quantity
D	ø180mm Paper Tape	15000
J	ø330mm Paper Tape	50000
B	Bulk(Bag)	1000

### Equivalent Circuit



(Resistance element becomes dominant at high frequencies.)

### Rated Value (□: packaging code)

Part Number		Impedance at 100MHz	Rated Current at 85°C	Rated Current at 125°C	DC Resistance (Max.)
Infotainment	Powertrain/Safety				
BLM03BC330SZ1□	—	33Ω±25%	150mA	150mA	0.85Ω
BLM03BC560SZ1□	—	56Ω±25%	100mA	100mA	1.05Ω
BLM03BC800SZ1□	—	80Ω±25%	100mA	100mA	1.4Ω

Operating Temp. Range: -55°C to 125°C

### Z-f characteristics

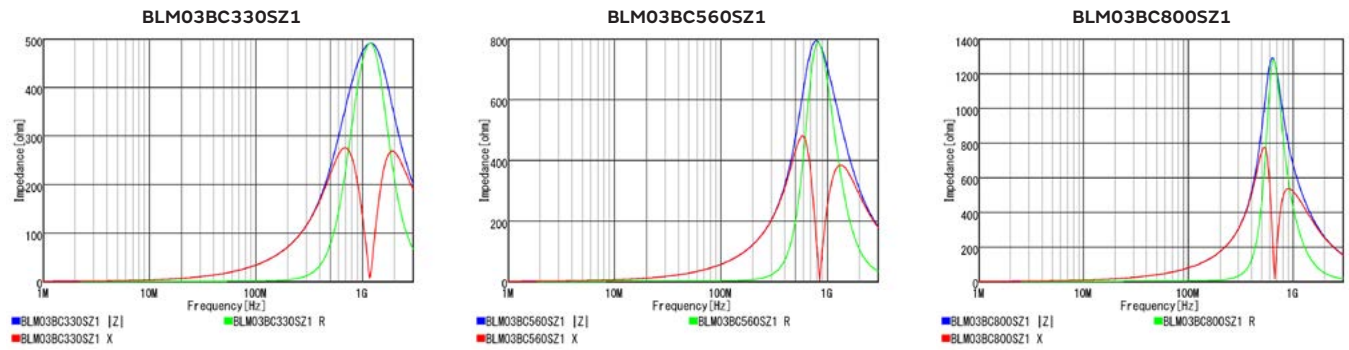

# Chip Ferrite Bead SMD Type

## BLM03BD Series 0201/0603(inch/mm)

### Specifications Sheet (with cautions/mounting/packaging)

Infotainment	<a href="https://www.murata.com/products/productdata/8796200435742/QNFA9126.pdf?1615959120000">https://www.murata.com/products/productdata/8796200435742/QNFA9126.pdf?1615959120000</a>
Powertrain/Safety	—

### Appearance/Dimensions

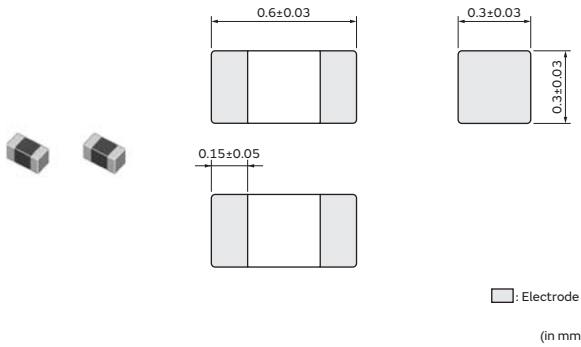

### Packaging

Code	Packaging	Minimum Quantity
D	ø180mm Paper Tape	15000
J	ø330mm Paper Tape	50000
B	Bulk(Bag)	1000

### Equivalent Circuit



(Resistance element becomes dominant at high frequencies.)

### Rated Value (□: packaging code)

Part Number		Impedance at 100MHz	Rated Current at 85°C	Rated Current at 125°C	DC Resistance (Max.)
Infotainment	Powertrain/Safety				
BLM03BD750SZ1□	—	75Ω±25%	300mA	300mA	0.4Ω
BLM03BD121SZ1□	—	120Ω±25%	250mA	250mA	0.5Ω
BLM03BD241SZ1□	—	240Ω±25%	200mA	200mA	0.8Ω
BLM03BD471SZ1□	—	470Ω±25%	215mA	215mA	1.5Ω
BLM03BD601SZ1□	—	600Ω±25%	200mA	200mA	1.7Ω

Operating Temp. Range: -55°C to 125°C

### Z-f characteristics

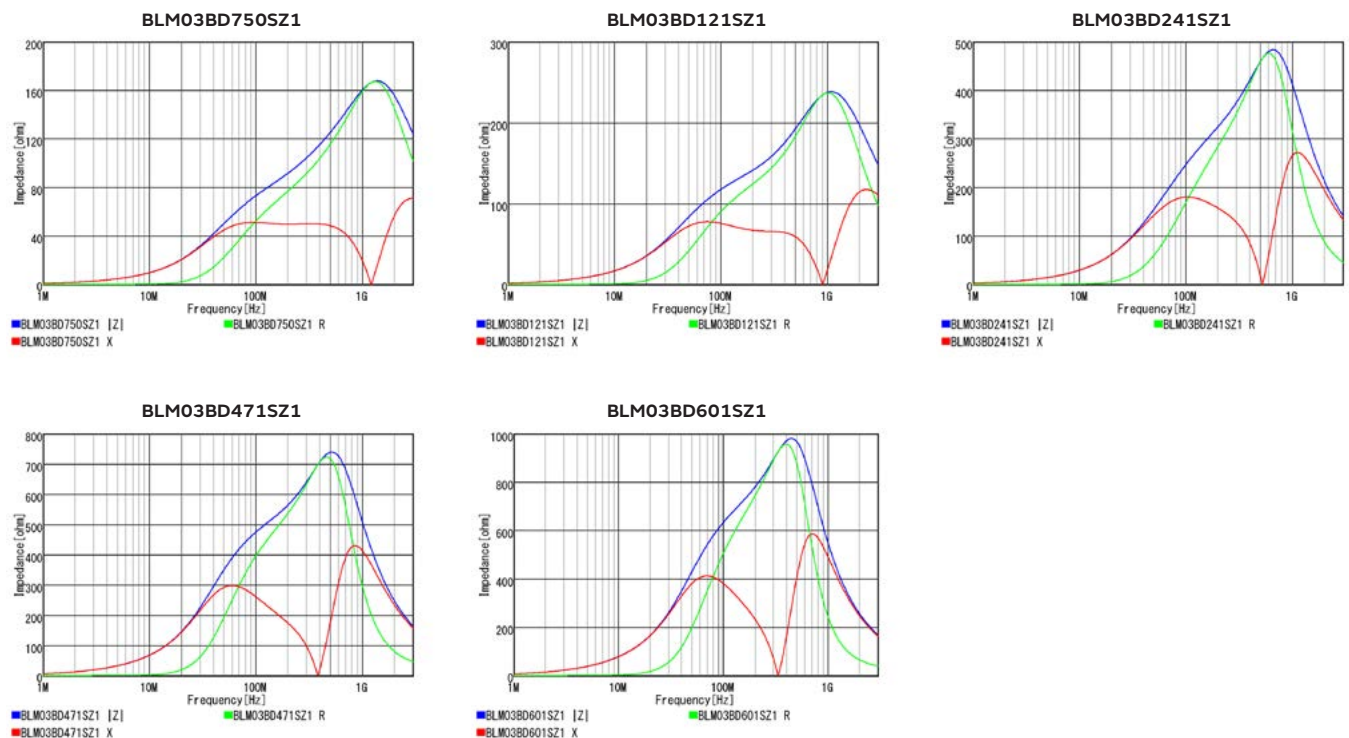



# Chip Ferrite Bead SMD Type

## BLM03HB Series 0201/0603(inch/mm)

### Specifications Sheet (with cautions/mounting/packaging)

Infotainment	<a href="https://www.murata.com/products/productdata/8796200468510/QNFA9127.pdf?1608273989000">https://www.murata.com/products/productdata/8796200468510/QNFA9127.pdf?1608273989000</a>
Powertrain/Safety	—

### Appearance/Dimensions

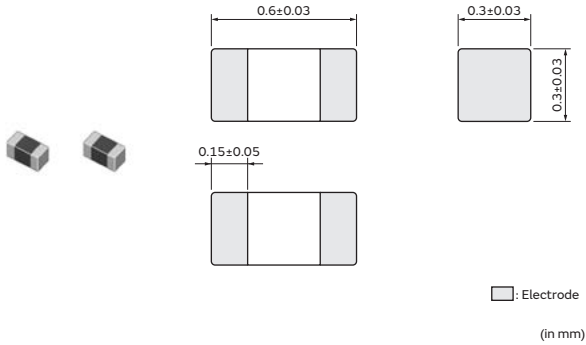

### Packaging

Code	Packaging	Minimum Quantity
D	ø180mm Paper Tape	15000
J	ø330mm Paper Tape	50000
B	Bulk(Bag)	1000

### Equivalent Circuit

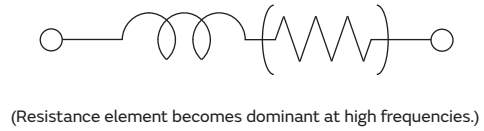

### Rated Value (□: packaging code)

Part Number		Impedance at 100MHz	Impedance at 1GHz	Rated Current at 85°C	Rated Current at 125°C	DC Resistance (Max.)
Infotainment	Powertrain/Safety					
BLM03HB191SZ1□	—	190Ω±25%	1150Ω±40%	150mA	150mA	2Ω
BLM03HB401SZ1□	—	400Ω±25%	1850Ω±40%	125mA	125mA	2.8Ω

Operating Temp. Range: -55°C to 125°C

### Z-f characteristics

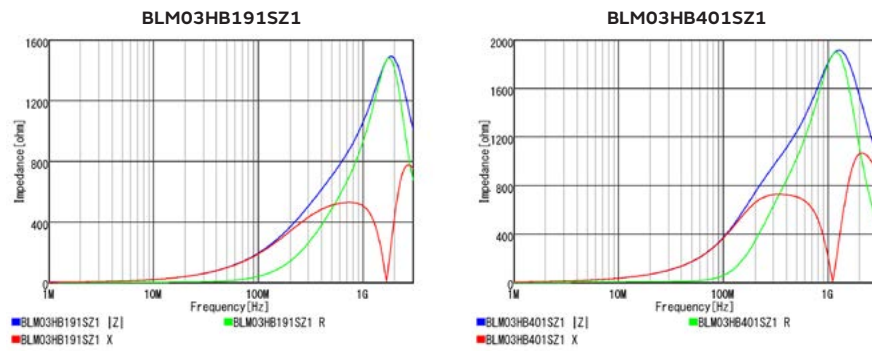

# Chip Ferrite Bead SMD Type

## BLM03HD Series 0201/0603(inch/mm)

### Specifications Sheet (with cautions/mounting/packaging)

Infotainment	<a href="https://www.murata.com/products/productdata/8796200468510/QNFA9127.pdf?1608273989000">https://www.murata.com/products/productdata/8796200468510/QNFA9127.pdf?1608273989000</a>
Powertrain/Safety	—

### Appearance/Dimensions

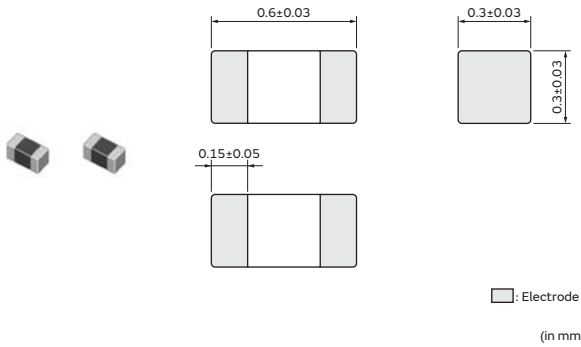

### Packaging

Code	Packaging	Minimum Quantity
D	ø180mm Paper Tape	15000
J	ø330mm Paper Tape	50000
B	Bulk(Bag)	1000

### Equivalent Circuit



(Resistance element becomes dominant at high frequencies.)

### Rated Value (□: packaging code)

Part Number		Impedance at 100MHz	Impedance at 1GHz	Rated Current at 85°C	Rated Current at 125°C	DC Resistance (Max.)
Infotainment	Powertrain/Safety					
BLM03HD331SZ1□	—	330Ω±25%	750Ω±40%	200mA	200mA	1Ω
BLM03HD471SZ1□	—	470Ω±25%	1000Ω±40%	175mA	175mA	1.3Ω
BLM03HD601SZ1□	—	600Ω±25%	1500Ω±40%	150mA	150mA	1.7Ω
BLM03HD102FZ1□	—	1000Ω±25%	2300Ω±40%	135mA	135mA	2.4Ω
BLM03HD102SZ1□	—	1000Ω±25%	2300Ω±40%	120mA	120mA	2.9Ω
BLM03HD152FZ1□	—	1500Ω±25%	2700Ω±40%	120mA	120mA	3.1Ω
BLM03HD182FZ1□	—	1800Ω±25%	3000Ω±40%	100mA	100mA	3.8Ω

Operating Temp. Range: -55°C to 125°C

### Z-f characteristics

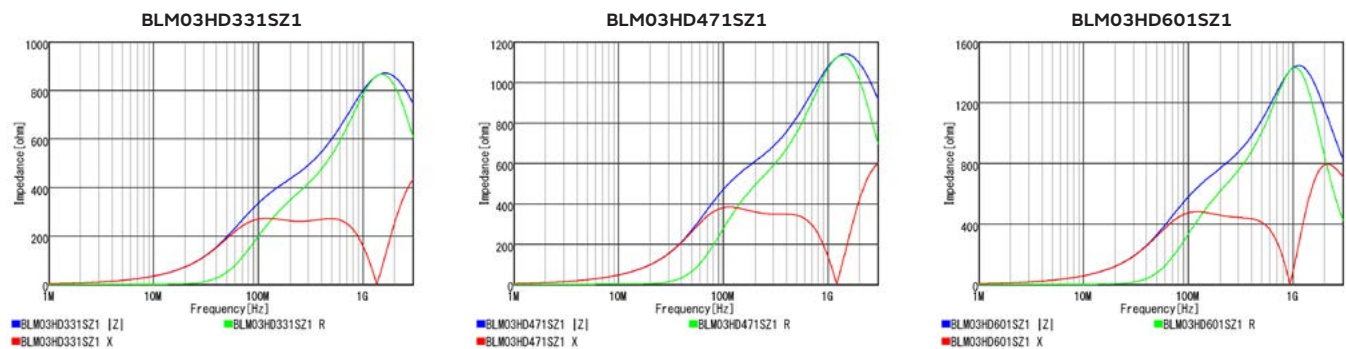

Continued on the following page. ↗



Continued from the preceding page. ↘

## Z-f characteristics

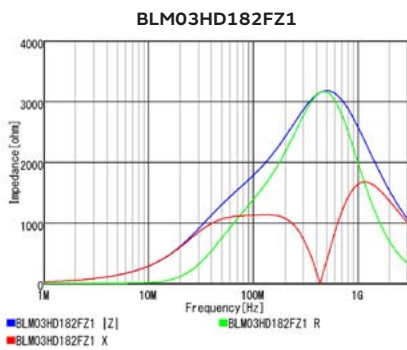
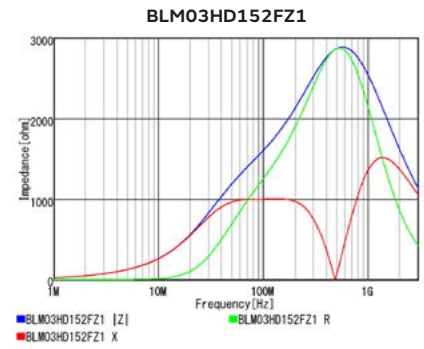
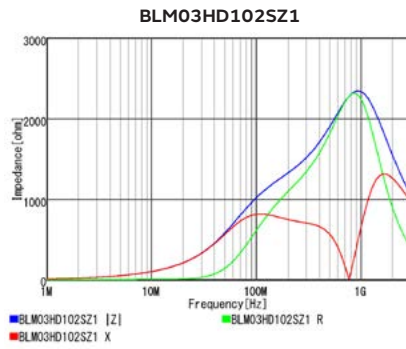
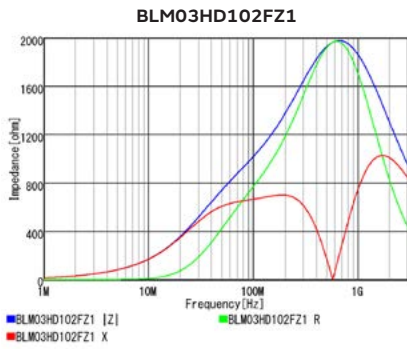

Chip Ferrite Bead

Chip EMI FIL

Chip Common Mode Choke Coil

Block Type EMI FIL

Microchip Transformer (Balun)

Inductors for Power Lines

Inductors for General Circuits

RF Inductors

# Chip Ferrite Bead SMD Type

## BLM03HG Series 0201/0603(inch/mm)

### Specifications Sheet (with cautions/mounting/packaging)

Infotainment	<a href="https://www.murata.com/products/productdata/8796200468510/QNFA9127.pdf?1608273989000">https://www.murata.com/products/productdata/8796200468510/QNFA9127.pdf?1608273989000</a>
Powertrain/Safety	<a href="https://www.murata.com/products/productdata/8799111217182/QNFA9134.pdf?1514423133000">https://www.murata.com/products/productdata/8799111217182/QNFA9134.pdf?1514423133000</a>

### Appearance/Dimensions

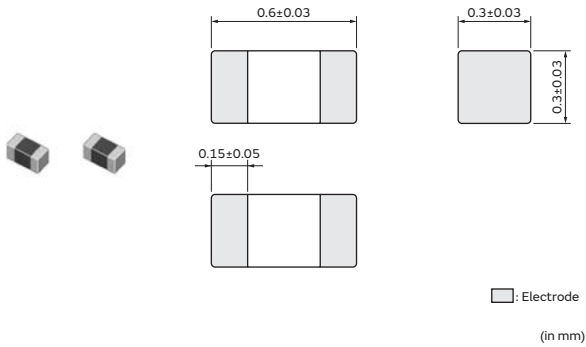

### Packaging

Code	Packaging	Minimum Quantity
D	ø180mm Paper Tape	15000
J	ø330mm Paper Tape	50000
B	Bulk(Bag)	1000

### Equivalent Circuit



(Resistance element becomes dominant at high frequencies.)

### Rated Value (□: packaging code)

Part Number		Impedance at 100MHz	Impedance at 1GHz	Rated Current at 85°C	Rated Current at 125°C	DC Resistance (Max.)
Infotainment	Powertrain/Safety					
BLM03HG601SZ1□	BLM03HG601SH1□	600Ω±25%	1000Ω±40%	150mA	150mA	1.6Ω
BLM03HG102SZ1□	BLM03HG102SH1□	1000Ω±25%	1800Ω±40%	125mA	125mA	2.6Ω
BLM03HG122SZ1□	BLM03HG122SH1□	1200Ω±25%	2000Ω±40%	100mA	100mA	3.5Ω

Operating Temp. Range: -55°C to 125°C

### Z-f characteristics

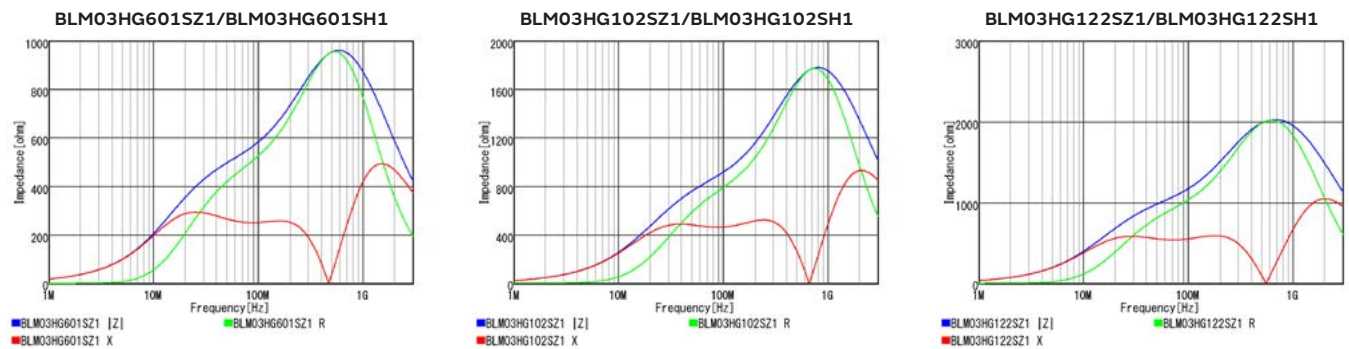

# Chip Ferrite Bead SMD Type

## BLM03EB Series 0201/0603(inch/mm)

### Specifications Sheet (with cautions/mounting/packaging)

Infotainment	<a href="https://www.murata.com/products/productdata/8796200501278/QNFA9128.pdf?1564717894000">https://www.murata.com/products/productdata/8796200501278/QNFA9128.pdf?1564717894000</a>
Powertrain/Safety	<a href="https://www.murata.com/products/productdata/8801633697822/QNFA9150.pdf?1523346151000">https://www.murata.com/products/productdata/8801633697822/QNFA9150.pdf?1523346151000</a>

### Appearance/Dimensions

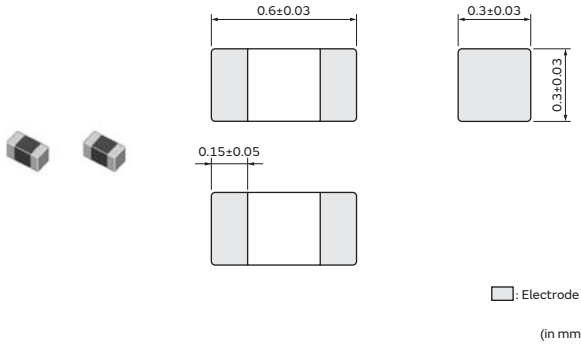

### Packaging

Code	Packaging	Minimum Quantity
D	ø180mm Paper Tape	15000
J	ø330mm Paper Tape	50000
B	Bulk(Bag)	1000

### Equivalent Circuit



(Resistance element becomes dominant at high frequencies.)

### Rated Value (□: packaging code)

Part Number		Impedance at 100MHz	Impedance at 1GHz	Rated Current at 85°C	Rated Current at 125°C	DC Resistance (Max.)
Infotainment	Powertrain/Safety					
BLM03EB250SZ1 □	BLM03EB250SH1 □	25Ω±25%	105Ω±40%	600mA	450mA	0.26Ω
BLM03EB500SZ1 □	BLM03EB500SH1 □	50Ω±25%	255Ω±40%	400mA	300mA	0.58Ω

Operating Temp. Range: -55°C to 125°C

### Z-f characteristics

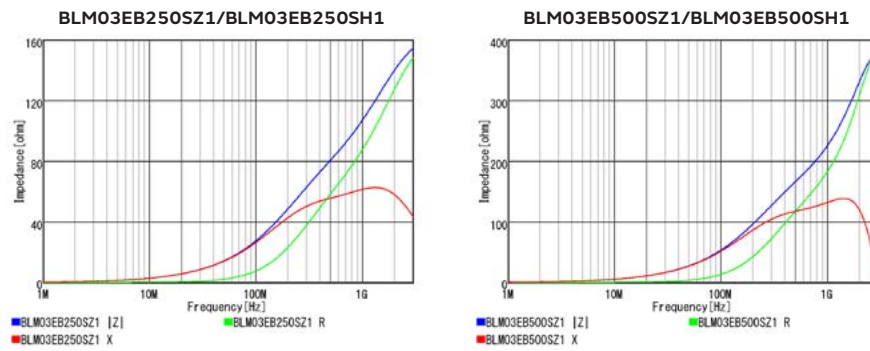

Continued on the following page. ↗

Continued from the preceding page. ↘

## Derating of Rated Current

In operating temperature exceeding +85°C, derating of current is necessary for BLM03E series.  
Please apply the derating curve shown in chart according to the operating temperature.

Derating of Rated Current

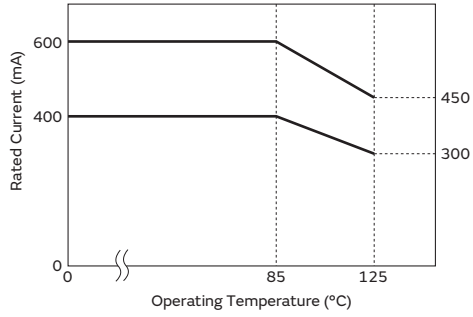

Chip Ferrite Bead

Chip EMIFIL

Chip Common Mode Choke Coil

Block Type EMIFIL

Microchip Transformer (Balun)

Inductors for Power Lines

Inductors for General Circuits

RF Inductors

# Chip Ferrite Bead SMD Type

## BLM15PD Series 0402/1005(inch/mm)

### Specifications Sheet (with cautions/mounting/packaging)

Infotainment	<a href="https://www.murata.com/products/productdata/8796200173598/QNFA9118.pdf?1613016712000">https://www.murata.com/products/productdata/8796200173598/QNFA9118.pdf?1613016712000</a>
Powertrain/Safety	—

### Appearance/Dimensions

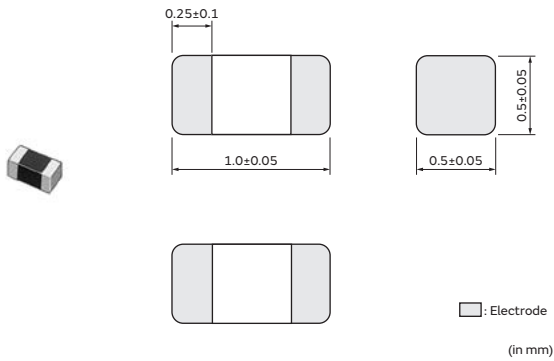

### Packaging

Code	Packaging	Minimum Quantity
D	ø180mm Paper Tape	10000
J	ø330mm Paper Tape	50000
B	Bulk(Bag)	1000

### Equivalent Circuit

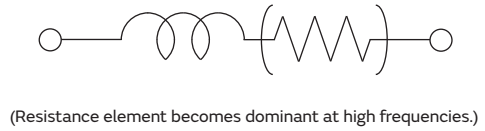

### Rated Value (□: packaging code)

Part Number		Impedance at 100MHz	Rated Current at 85°C	Rated Current at 125°C	DC Resistance (Max.)
Infotainment	Powertrain/Safety				
BLM15PD300SZ1□	—	30Ω±25%	2.2A	1.4A	0.035Ω
BLM15PD600SZ1□	—	60Ω±25%	1.7A	1.1A	0.06Ω
BLM15PD800SZ1□	—	80Ω±25%	1.5A	1A	0.07Ω
BLM15PD121SZ1□	—	120Ω±25%	1.3A	900mA	0.09Ω

Operating Temp. Range: -55°C to 125°C

### Z-f characteristics

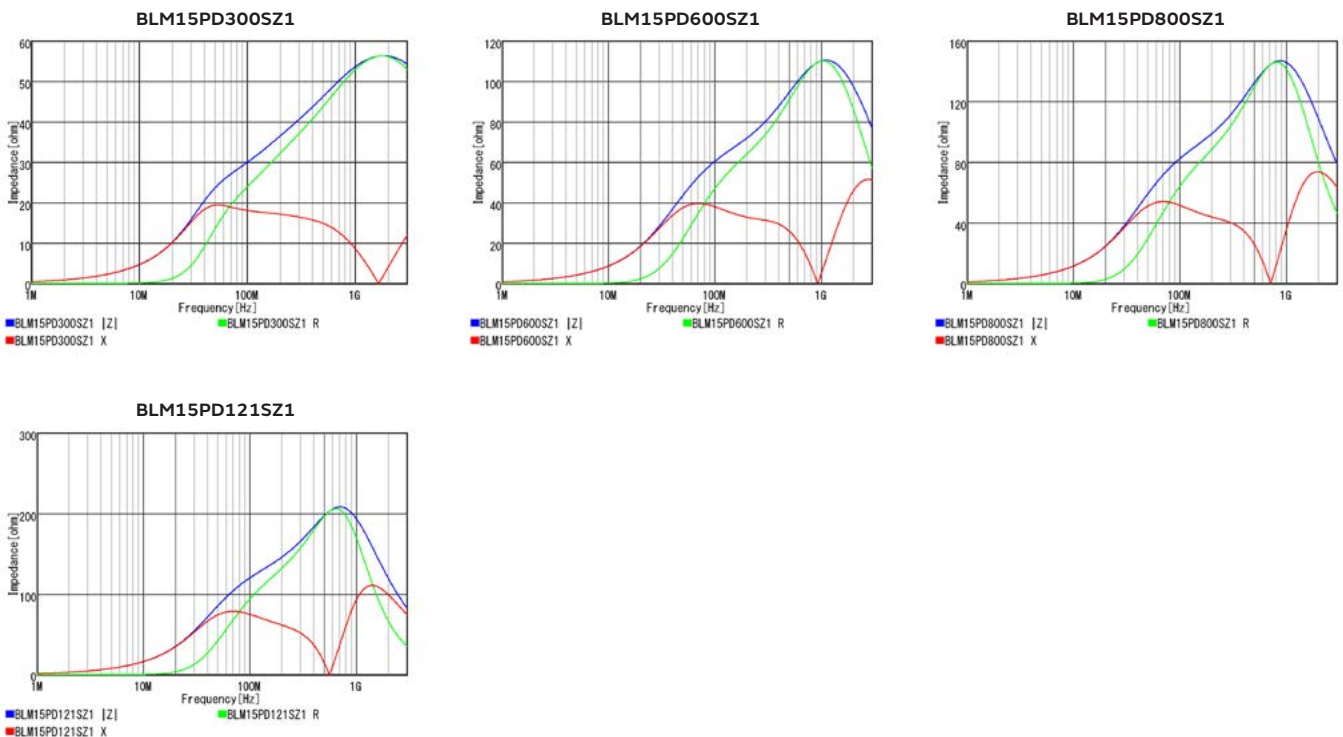

Continued on the following page. ↗

Continued from the preceding page. ↘

## Derating of Rated Current

In operating temperature exceeding +85°C, derating of current is necessary for BLM15PD series.  
Please apply the derating curve shown in chart according to the operating temperature.

Derating of Rated Current

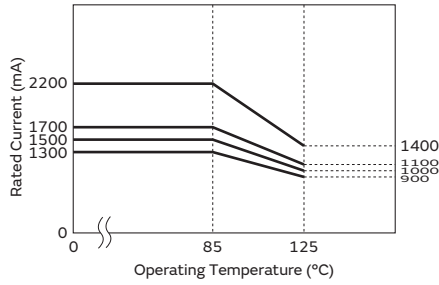

# Chip Ferrite Bead SMD Type

## BLM15PE Series 0402/1005(inch/mm)

### Specifications Sheet (with cautions/mounting/packaging)

Infotainment	—
Powertrain/Safety	<a href="https://www.murata.com/products/productdata/8796199387166/QNFA9103.pdf?1604283269000">https://www.murata.com/products/productdata/8796199387166/QNFA9103.pdf?1604283269000</a>

### Appearance/Dimensions

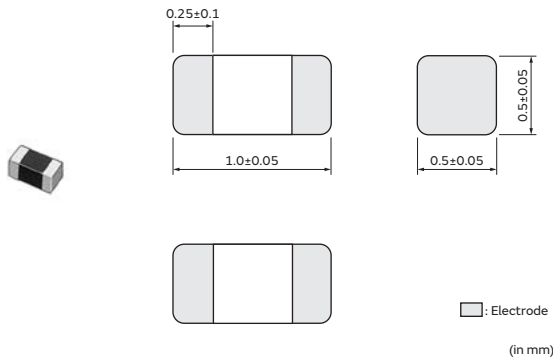

### Packaging

Code	Packaging	Minimum Quantity
D	ø180mm Paper Tape	10000
J	ø330mm Paper Tape	50000
B	Bulk(Bag)	1000

### Equivalent Circuit

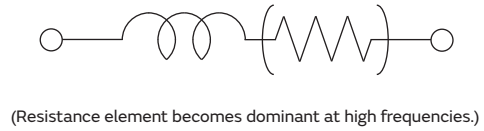

### Rated Value (□: packaging code)

Part Number		Impedance at 100MHz	Rated Current at 85°C	Rated Current at 125°C	DC Resistance (Max.)
Infotainment	Powertrain/Safety				
—	BLM15PE300SH1□	30Ω±25%	2.3A	1.4A	0.035Ω
—	BLM15PE600SH1□	60Ω±25%	1.8A	1.1A	0.06Ω
—	BLM15PE800SH1□	80Ω±25%	1.7A	1A	0.07Ω
—	BLM15PE121SH1□	120Ω±25%	1.5A	900mA	0.09Ω
—	BLM15PE181SH1□	180Ω±25%	1.2A	700mA	0.14Ω
—	BLM15PE221SH1□	220Ω±25%	1.1A	650mA	0.17Ω
—	BLM15PE331SH1□	330Ω±25%	1A	580mA	0.21Ω
—	BLM15PE471SH1□	470Ω±25%	750mA	450mA	0.35Ω
—	BLM15PE601SH1□	600Ω±25%	700mA	420mA	0.4Ω

Operating Temp. Range: -55°C to 125°C

### Z-f characteristics

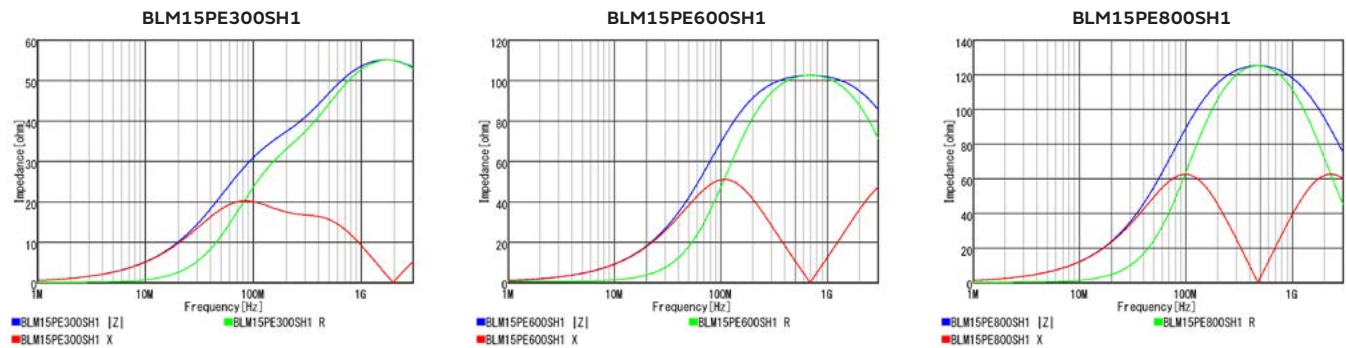

Continued on the following page. ↗

Continued from the preceding page. ↘

## Z-f characteristics

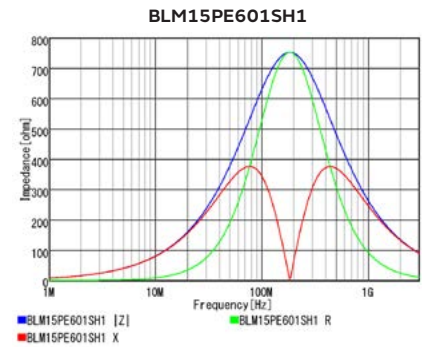
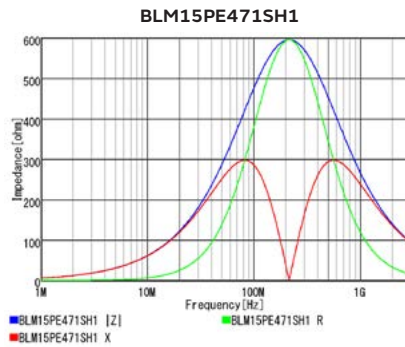
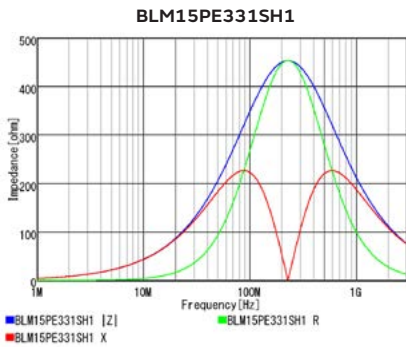
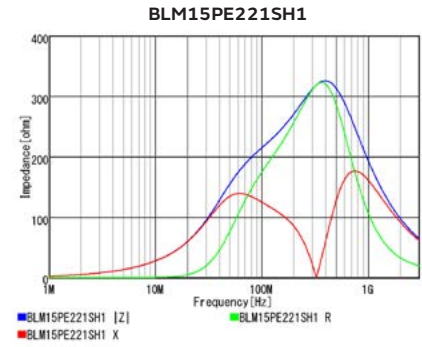
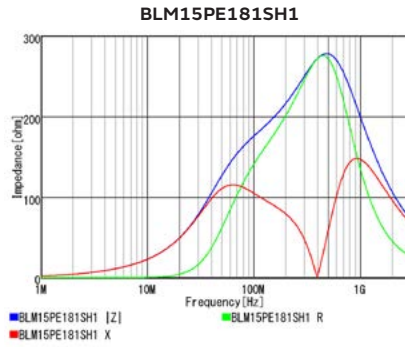
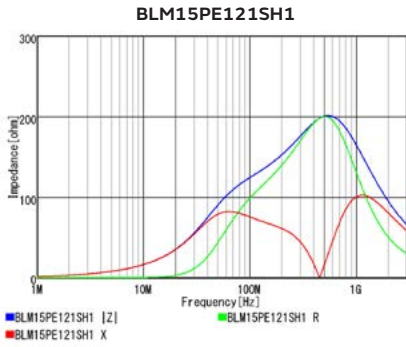

## Derating of Rated Current

In operating temperature exceeding +85°C, derating of current is necessary for this series.  
 Please apply the derating curve shown in chart according to the operating temperature.

Derating of Rated Current

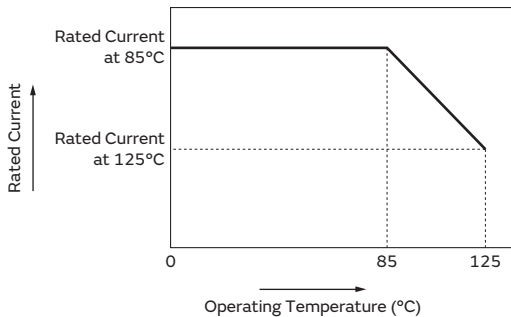

Chip Ferrite Bead  
 Chip EMIFIL  
 Chip Common Mode Choke Coil  
 Block Type EMIFIL  
 Microchip Transformer (Balun)  
 Inductors for Power Lines  
 Inductors for General Circuits  
 RF Inductors



# Chip Ferrite Bead SMD Type

## BLM15PG Series 0402/1005(inch/mm)

### Specifications Sheet (with cautions/mounting/packaging)

Infotainment	<a href="https://www.murata.com/products/productdata/8796200173598/QNFA9118.pdf?1613016712000">https://www.murata.com/products/productdata/8796200173598/QNFA9118.pdf?1613016712000</a>
Powertrain/Safety	—

### Appearance/Dimensions

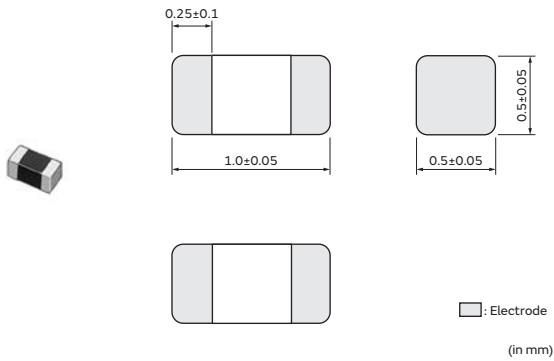

### Packaging

Code	Packaging	Minimum Quantity
D	∅180mm Paper Tape	10000
J	∅330mm Paper Tape	50000
B	Bulk(Bag)	1000

### Equivalent Circuit

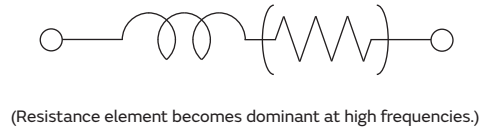

### Rated Value (□: packaging code)

Part Number		Impedance at 100MHz	Rated Current at 85°C	Rated Current at 125°C	DC Resistance (Max.)	Operating Temp. Range
Infotainment	Powertrain/Safety					
BLM15PG100SZ1□	—	10Ω(Typ.)	1A	1A	0.025Ω	-55°C to 125°C

### Z-f characteristics

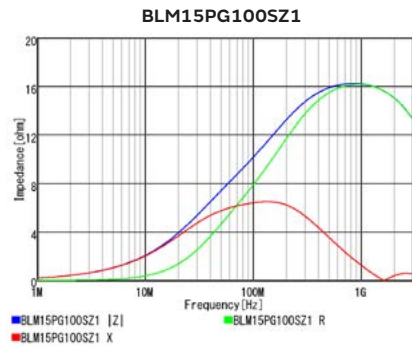

# Chip Ferrite Bead SMD Type

## BLM15PX Series 0402/1005(inch/mm)

### Specifications Sheet (with cautions/mounting/packaging)

Infotainment	<a href="https://www.murata.com/products/productdata/8796200173598/QNFA9118.pdf?1613016712000">https://www.murata.com/products/productdata/8796200173598/QNFA9118.pdf?1613016712000</a>
Powertrain/Safety	—

### Appearance/Dimensions

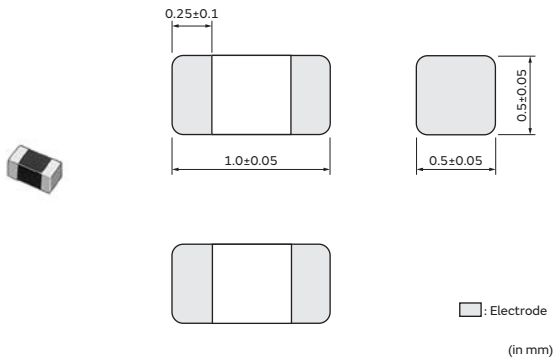

### Packaging

Code	Packaging	Minimum Quantity
D	ø180mm Paper Tape	10000
J	ø330mm Paper Tape	50000
B	Bulk(Bag)	1000

### Equivalent Circuit



(Resistance element becomes dominant at high frequencies.)

### Rated Value (□: packaging code)

Part Number		Impedance at 100MHz	Rated Current at 85°C	Rated Current at 125°C	DC Resistance (Max.)
Infotainment	Powertrain/Safety				
BLM15PX330SZ1□	—	33Ω±25%	3A	1.7A	0.022Ω
BLM15PX600SZ1□	—	60Ω±25%	2.5A	1.4A	0.032Ω
BLM15PX800SZ1□	—	80Ω±25%	2.3A	1.3A	0.038Ω
BLM15PX121SZ1□	—	120Ω±25%	2A	1.1A	0.055Ω
BLM15PX181SZ1□	—	180Ω±25%	1.5A	800mA	0.09Ω
BLM15PX221SZ1□	—	220Ω±25%	1.4A	800mA	0.1Ω
BLM15PX331SZ1□	—	330Ω±25%	1.2A	700mA	0.15Ω
BLM15PX471SZ1□	—	470Ω±25%	1A	600mA	0.2Ω
BLM15PX601SZ1□	—	600Ω±25%	900mA	500mA	0.23Ω

Operating Temp. Range: -55°C to 125°C

### Z-f characteristics

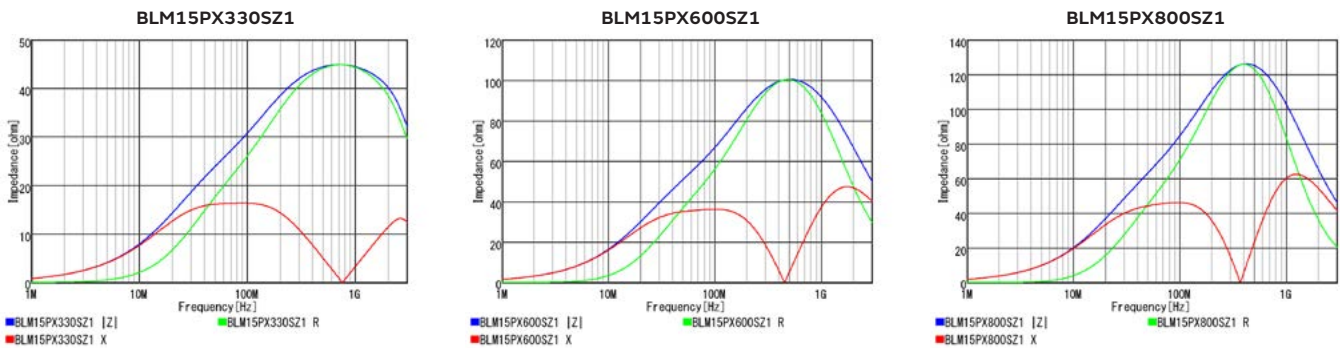

Continued on the following page. ↗

Continued from the preceding page. ↘

## Z-f characteristics

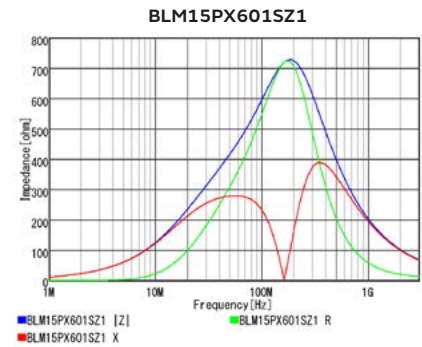
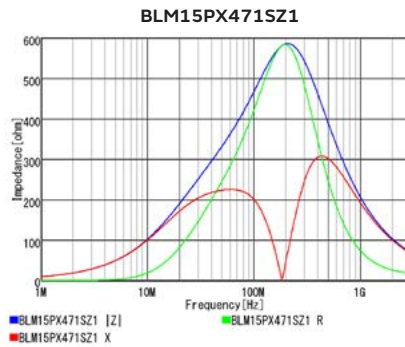
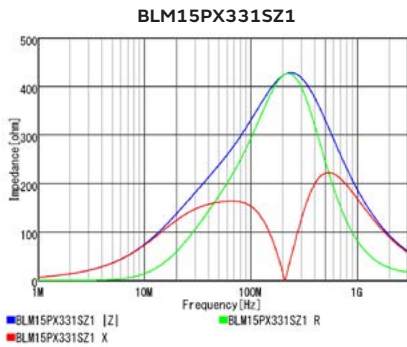
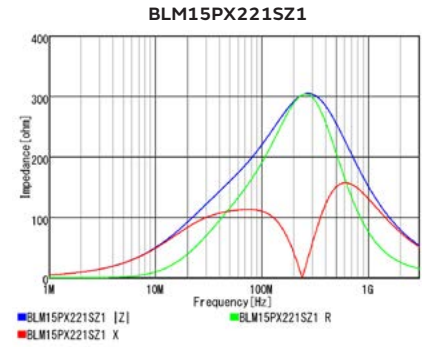
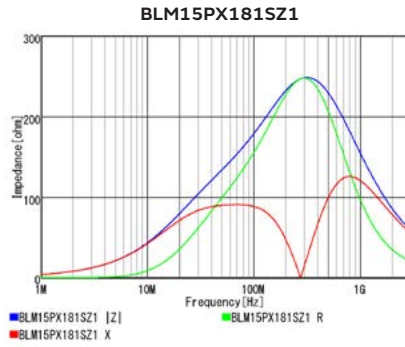
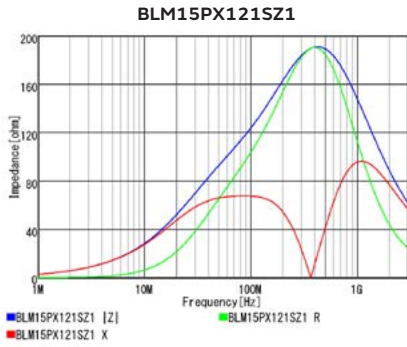

## Derating of Rated Current

In operating temperature exceeding +85°C, derating of current is necessary for BLM15PX series.  
 Please apply the derating curve shown in chart according to the operating temperature.

Derating of Rated Current

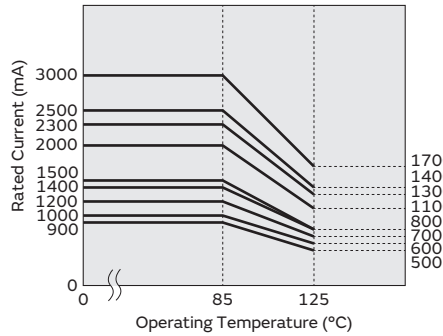

# Chip Ferrite Bead SMD Type

## BLM15AX Series 0402/1005(inch/mm)

### Specifications Sheet (with cautions/mounting/packaging)

Infotainment	<a href="https://www.murata.com/products/productdata/8796200173598/QNFA9118.pdf?1613016712000">https://www.murata.com/products/productdata/8796200173598/QNFA9118.pdf?1613016712000</a>
Powertrain/Safety	—

### Appearance/Dimensions

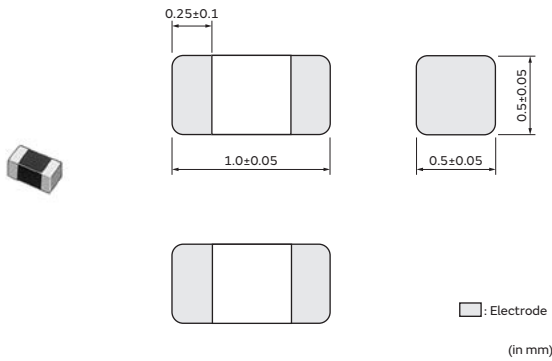

### Packaging

Code	Packaging	Minimum Quantity
D	ø180mm Paper Tape	10000
J	ø330mm Paper Tape	50000
B	Bulk(Bag)	1000

### Equivalent Circuit



(Resistance element becomes dominant at high frequencies.)

### Rated Value (□: packaging code)

Part Number		Impedance at 100MHz	Rated Current at 85°C	Rated Current at 125°C	DC Resistance (Max.)
Infotainment	Powertrain/Safety				
BLM15AX100SZ1□	—	10Ω±5Ω	1.74A	1.74A	0.015Ω
BLM15AX300SZ1□	—	30Ω±25%	1.1A	1.1A	0.06Ω
BLM15AX700SZ1□	—	70Ω±25%	780mA	780mA	0.1Ω
BLM15AX121SZ1□	—	120Ω±25%	700mA	700mA	0.13Ω
BLM15AX221SZ1□	—	220Ω±25%	600mA	600mA	0.18Ω
BLM15AX601SZ1□	—	600Ω±25%	500mA	500mA	0.34Ω
BLM15AX102SZ1□	—	1000Ω±25%	350mA	350mA	0.49Ω

Operating Temp. Range: -55°C to 125°C

### Z-f characteristics

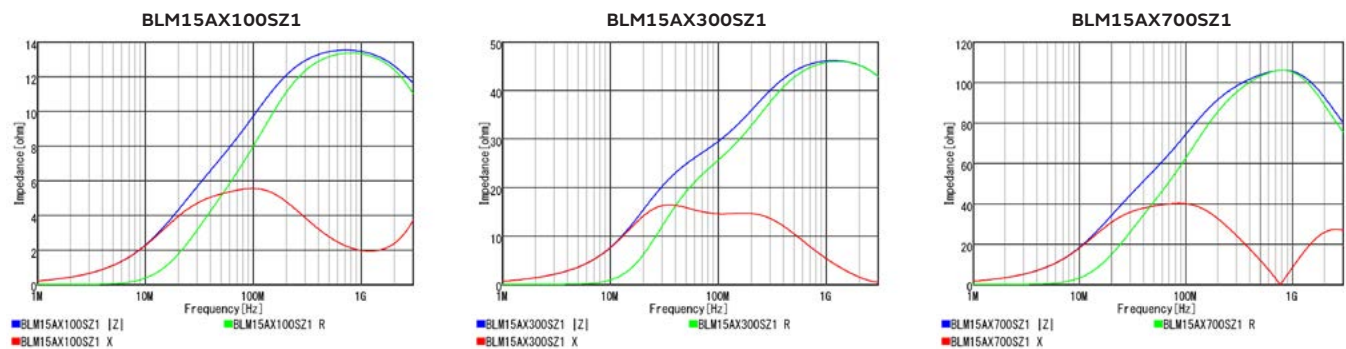

Continued on the following page. ↗

Continued from the preceding page. ↘

## Z-f characteristics

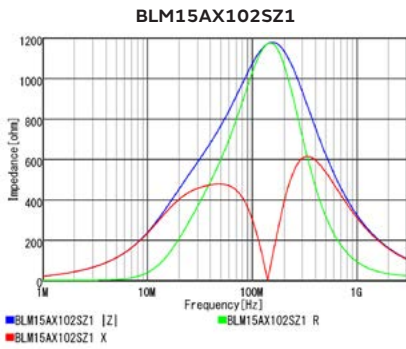
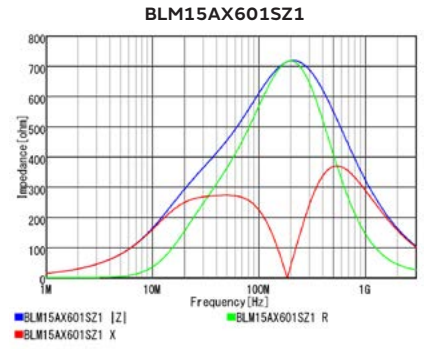
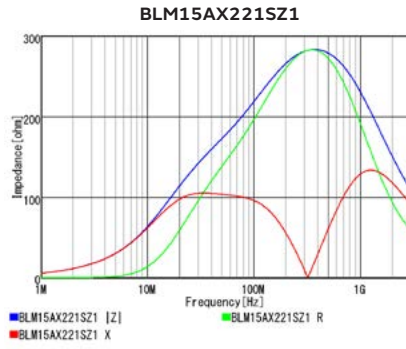
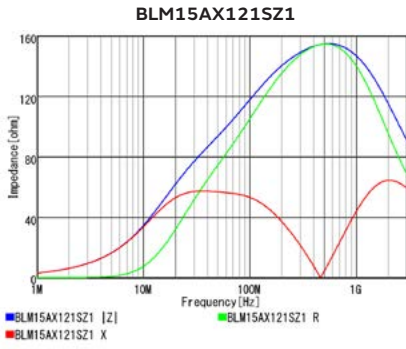

Chip Ferrite Bead

Chip EMI FIL

Chip Common Mode  
 Choke Coil

Block Type EMI FIL

Microchip Transformer  
 (Balun)

Inductors  
 for Power Lines

Inductors for  
 General Circuits

RF Inductors

# Chip Ferrite Bead SMD Type

## BLM15AG Series 0402/1005(inch/mm)

### Specifications Sheet (with cautions/mounting/packaging)

Infotainment	<a href="https://www.murata.com/products/productdata/8796200173598/QNFA9118.pdf?1613016712000">https://www.murata.com/products/productdata/8796200173598/QNFA9118.pdf?1613016712000</a>
Powertrain/Safety	<a href="https://www.murata.com/products/productdata/8796199387166/QNFA9103.pdf?1604283269000">https://www.murata.com/products/productdata/8796199387166/QNFA9103.pdf?1604283269000</a>

### Appearance/Dimensions

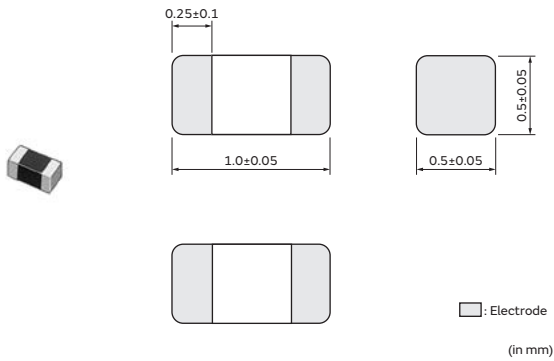

### Packaging

Code	Packaging	Minimum Quantity
D	ø180mm Paper Tape	10000
J	ø330mm Paper Tape	50000
B	Bulk(Bag)	1000

### Equivalent Circuit



(Resistance element becomes dominant at high frequencies.)

### Rated Value (□: packaging code)

Part Number		Impedance at 100MHz	Rated Current at 85°C	Rated Current at 125°C	DC Resistance (Max.)
Infotainment	Powertrain/Safety				
BLM15AG100SZ1□	BLM15AG100SH1□	10Ω(Typ.)	1A	1A	0.025Ω/0.05Ω
BLM15AG700SZ1□	BLM15AG700SH1□	70Ω(Typ.)	600mA/500mA	600mA/500mA	0.15Ω
BLM15AG121SZ1□	BLM15AG121SH1□	120Ω±25%	550mA/500mA	550mA/500mA	0.19Ω/0.25Ω
BLM15AG221SZ1□	BLM15AG221SH1□	220Ω±25%	450mA/300mA	450mA/300mA	0.29Ω/0.35Ω
BLM15AG601SZ1□	BLM15AG601SH1□	600Ω±25%	300mA	300mA	0.52Ω/0.6Ω
BLM15AG102SZ1□	BLM15AG102SH1□	1000Ω±25%	300mA/200mA	300mA/200mA	0.65Ω/1Ω

Operating Temp. Range: -55°C to 125°C

### Z-f characteristics

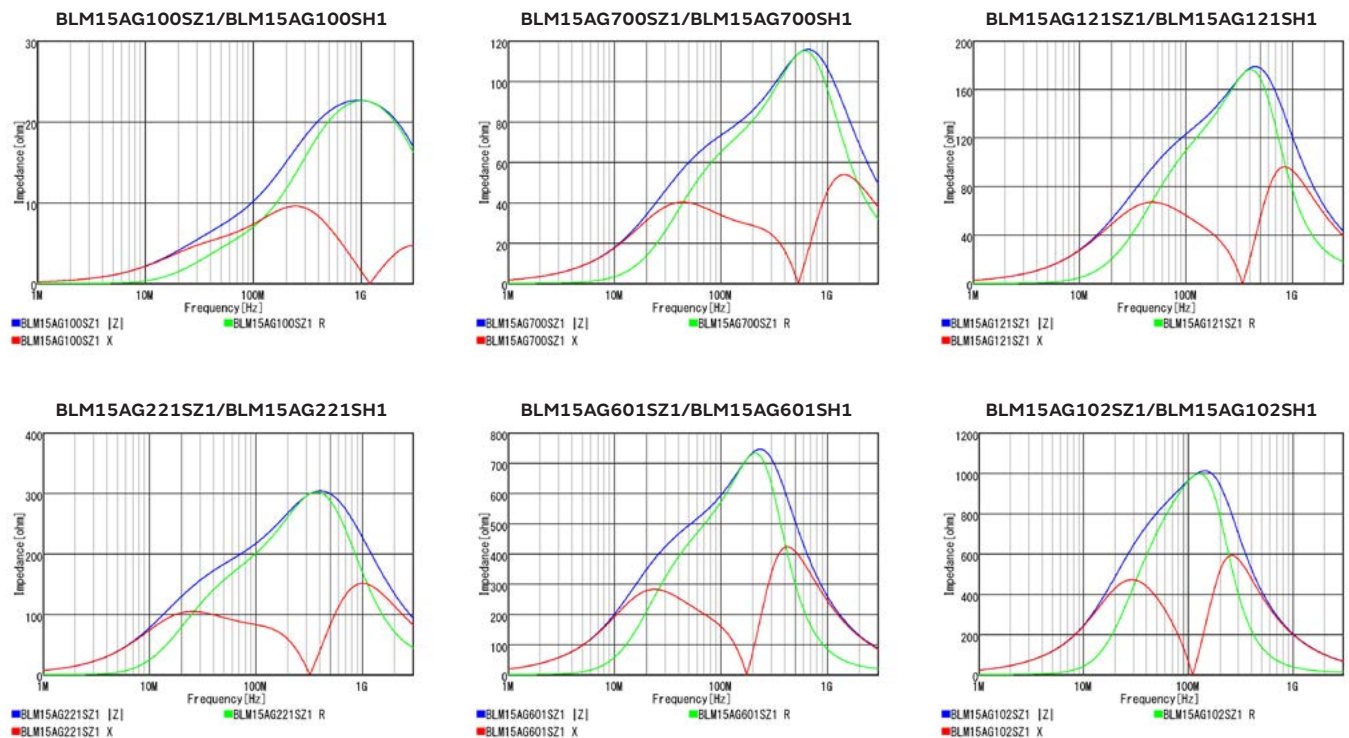



# Chip Ferrite Bead SMD Type

## BLM15BA Series 0402/1005(inch/mm)

### Specifications Sheet (with cautions/mounting/packaging)

Infotainment	<a href="https://www.murata.com/products/productdata/8796200173598/QNFA9118.pdf?1613016712000">https://www.murata.com/products/productdata/8796200173598/QNFA9118.pdf?1613016712000</a>
Powertrain/Safety	—

### Appearance/Dimensions

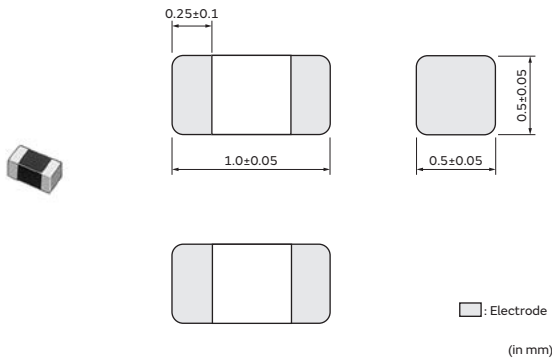

### Packaging

Code	Packaging	Minimum Quantity
D	ø180mm Paper Tape	10000
J	ø330mm Paper Tape	50000
B	Bulk(Bag)	1000

### Equivalent Circuit

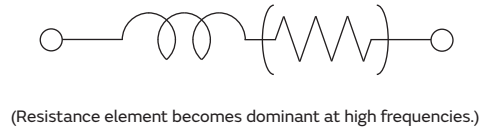

### Rated Value (□: packaging code)

Part Number		Impedance at 100MHz	Rated Current at 85°C	Rated Current at 125°C	DC Resistance (Max.)
Infotainment	Powertrain/Safety				
BLM15BA050SZ1□	—	5Ω±25%	300mA	300mA	0.1Ω
BLM15BA100SZ1□	—	10Ω±25%	300mA	300mA	0.2Ω
BLM15BA220SZ1□	—	22Ω±25%	300mA	300mA	0.3Ω
BLM15BA330SZ1□	—	33Ω±25%	300mA	300mA	0.4Ω
BLM15BA470SZ1□	—	47Ω±25%	200mA	200mA	0.6Ω
BLM15BA750SZ1□	—	75Ω±25%	200mA	200mA	0.8Ω

Operating Temp. Range: -55°C to 125°C

### Z-f characteristics

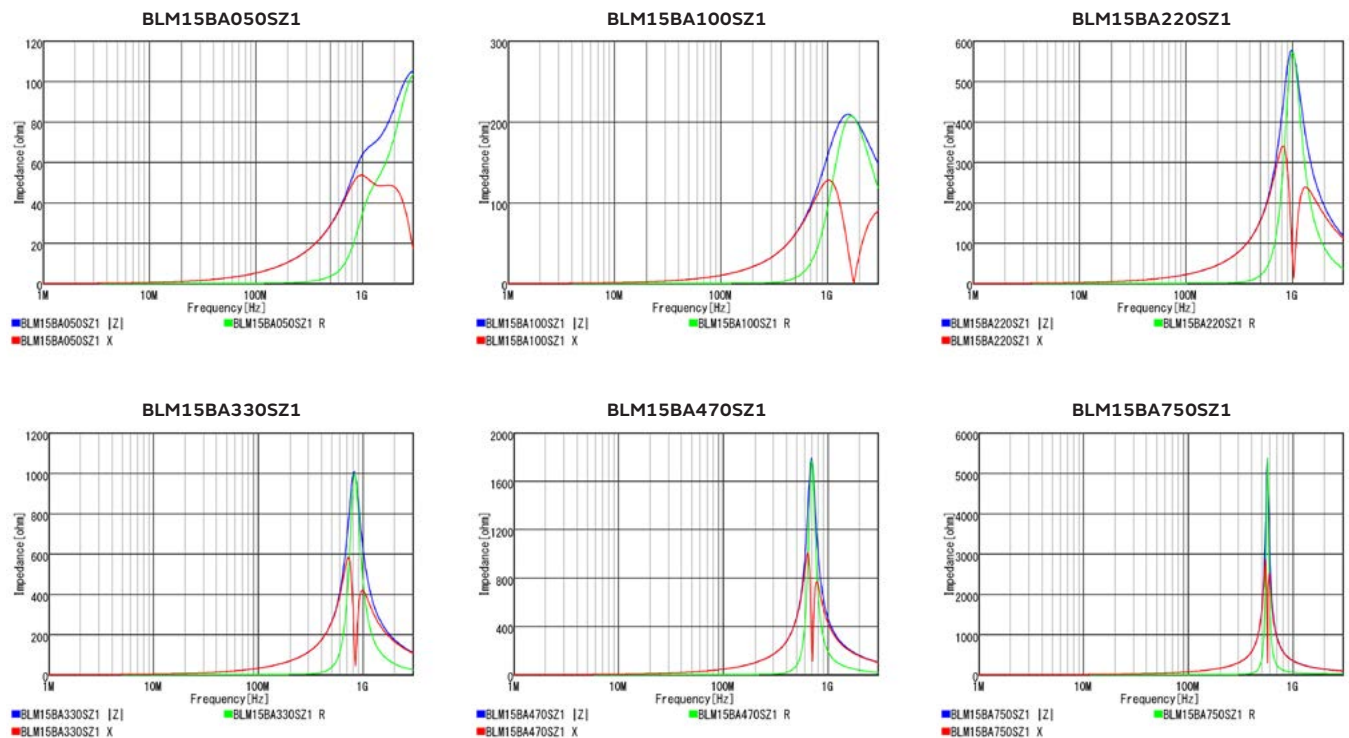

# Chip Ferrite Bead SMD Type

## BLM15BB Series 0402/1005(inch/mm)

### Specifications Sheet (with cautions/mounting/packaging)

Infotainment	<a href="https://www.murata.com/products/productdata/8796200173598/QNFA9118.pdf?1613016712000">https://www.murata.com/products/productdata/8796200173598/QNFA9118.pdf?1613016712000</a>
Powertrain/Safety	<a href="https://www.murata.com/products/productdata/8796199387166/QNFA9103.pdf?1604283269000">https://www.murata.com/products/productdata/8796199387166/QNFA9103.pdf?1604283269000</a>

### Appearance/Dimensions

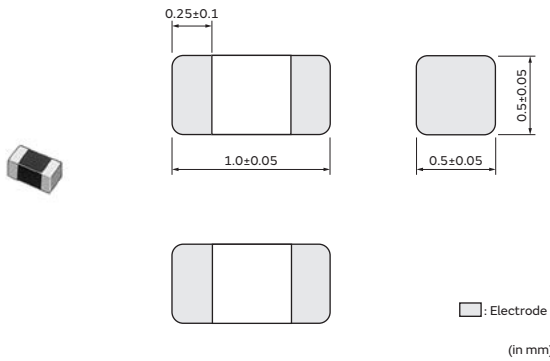

### Packaging

Code	Packaging	Minimum Quantity
D	ø180mm Paper Tape	10000
J	ø330mm Paper Tape	50000
B	Bulk(Bag)	1000

### Equivalent Circuit



(Resistance element becomes dominant at high frequencies.)

### Rated Value (□: packaging code)

Part Number		Impedance at 100MHz	Rated Current at 85°C	Rated Current at 125°C	DC Resistance (Max.)
Infotainment	Powertrain/Safety				
BLM15BB050SZ1□	BLM15BB050SH1□	5Ω±25%	500mA	500mA	0.08Ω
BLM15BB100SZ1□	BLM15BB100SH1□	10Ω±25%	300mA	300mA	0.1Ω
BLM15BB220SZ1□	BLM15BB220SH1□	22Ω±25%	300mA	300mA	0.2Ω
BLM15BB470SZ1□	BLM15BB470SH1□	47Ω±25%	300mA	300mA	0.35Ω
BLM15BB750SZ1□	BLM15BB750SH1□	75Ω±25%	300mA	300mA	0.4Ω
BLM15BB121SZ1□	BLM15BB121SH1□	120Ω±25%	300mA	300mA	0.55Ω
BLM15BB221SZ1□	BLM15BB221SH1□	220Ω±25%	200mA	200mA	0.8Ω

Operating Temp. Range: -55°C to 125°C

### Z-f characteristics

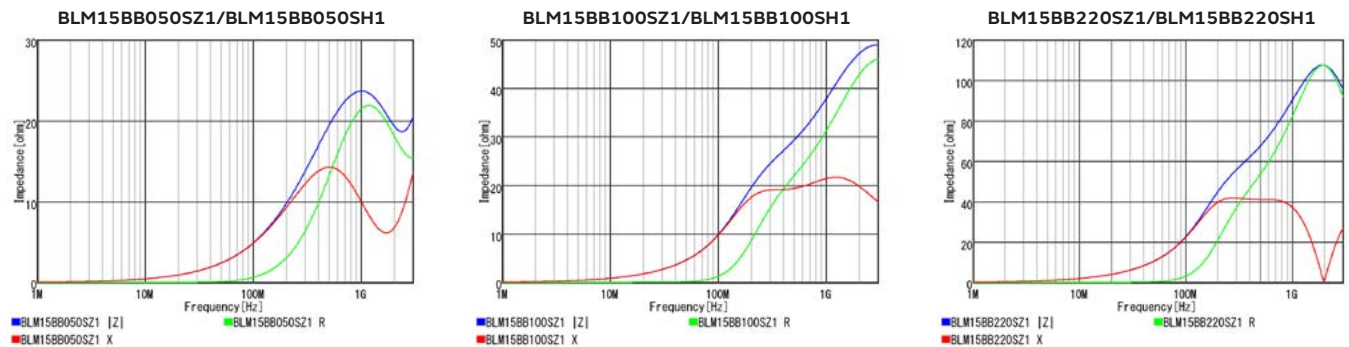

Continued on the following page. ↗



Continued from the preceding page. ↘

## Z-f characteristics

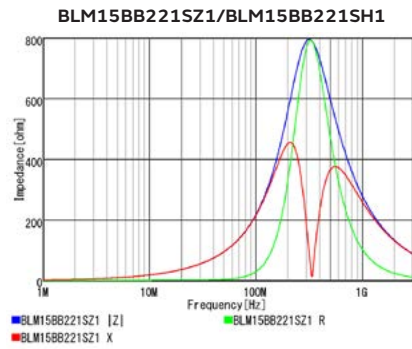
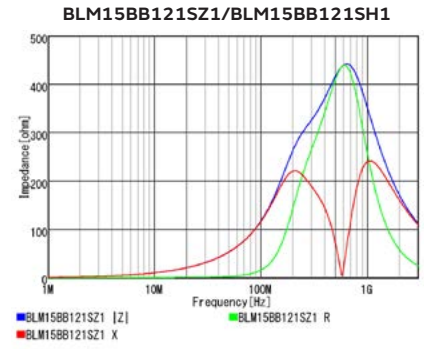
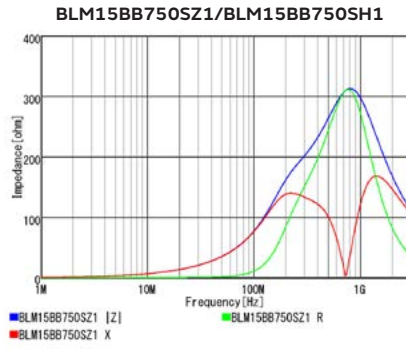
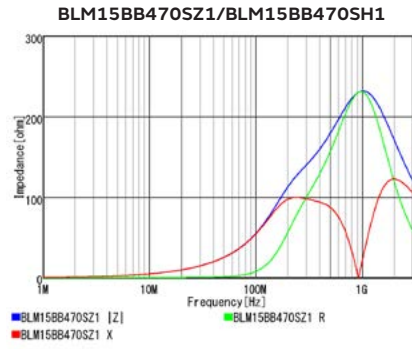

Chip Ferrite Bead

Chip EMI FIL

Chip Common Mode  
 Choke Coil

Block Type EMI FIL

Microchip Transformer  
 (Balun)

Inductors  
 for Power Lines

Inductors for  
 General Circuits

RF Inductors

# Chip Ferrite Bead SMD Type

## BLM15BC Series 0402/1005(inch/mm)

### Specifications Sheet (with cautions/mounting/packaging)

Infotainment	<a href="https://www.murata.com/products/productdata/8796200173598/QNFA9118.pdf?1613016712000">https://www.murata.com/products/productdata/8796200173598/QNFA9118.pdf?1613016712000</a>
Powertrain/Safety	—

### Appearance/Dimensions

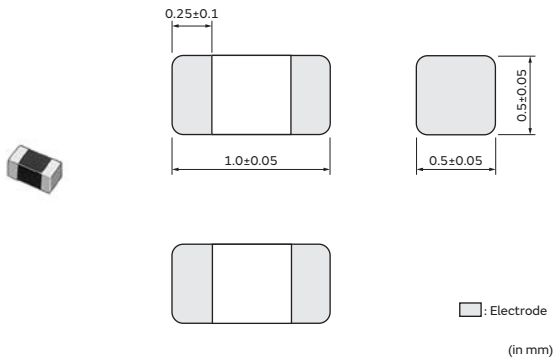

### Packaging

Code	Packaging	Minimum Quantity
D	ø180mm Paper Tape	10000
J	ø330mm Paper Tape	50000
B	Bulk(Bag)	1000

### Equivalent Circuit



(Resistance element becomes dominant at high frequencies.)

### Rated Value (□: packaging code)

Part Number		Impedance at 100MHz	Rated Current at 85°C	Rated Current at 125°C	DC Resistance (Max.)
Infotainment	Powertrain/Safety				
BLM15BC121SZ1□	—	120Ω±25%	350mA	350mA	0.45Ω
BLM15BC241SZ1□	—	240Ω±25%	250mA	250mA	0.7Ω

Operating Temp. Range: -55°C to 125°C

### Z-f characteristics

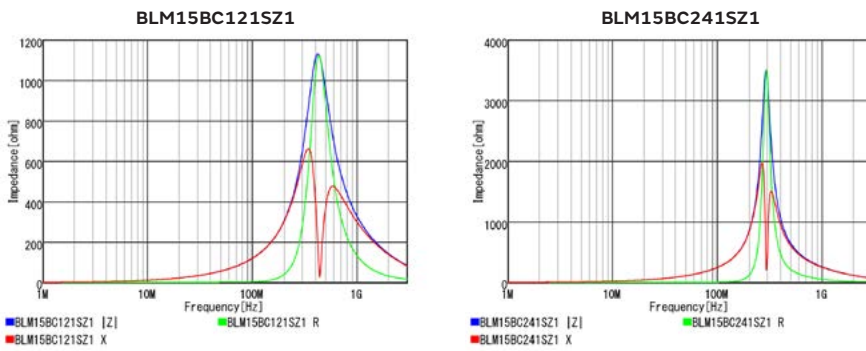

# Chip Ferrite Bead SMD Type

## BLM15BD Series 0402/1005(inch/mm)

### Specifications Sheet (with cautions/mounting/packaging)

Infotainment	<a href="https://www.murata.com/products/productdata/8796200173598/QNFA9118.pdf?1613016712000">https://www.murata.com/products/productdata/8796200173598/QNFA9118.pdf?1613016712000</a>
Powertrain/Safety	<a href="https://www.murata.com/products/productdata/8796199387166/QNFA9103.pdf?1604283269000">https://www.murata.com/products/productdata/8796199387166/QNFA9103.pdf?1604283269000</a>

### Appearance/Dimensions

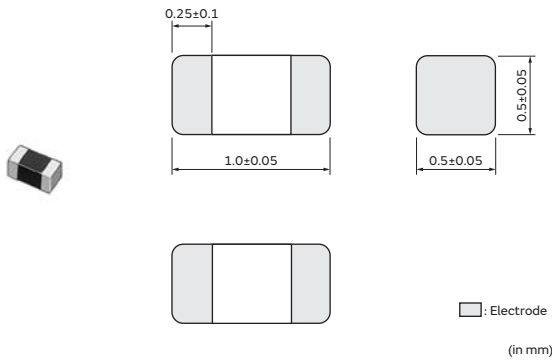

### Packaging

Code	Packaging	Minimum Quantity
D	ø180mm Paper Tape	10000
J	ø330mm Paper Tape	50000
B	Bulk(Bag)	1000

### Equivalent Circuit

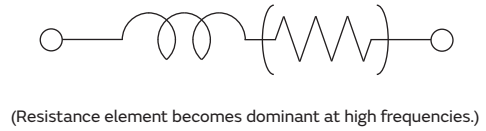

### Rated Value (□: packaging code)

Part Number		Impedance at 100MHz	Rated Current at 85°C	Rated Current at 125°C	DC Resistance (Max.)
Infotainment	Powertrain/Safety				
BLM15BD750SZ1□	—	75Ω±25%	300mA	300mA	0.2Ω
BLM15BD121SZ1□	—	120Ω±25%	300mA	300mA	0.3Ω
BLM15BD221SZ1□	—	220Ω±25%	300mA	300mA	0.4Ω
BLM15BD471SZ1□	BLM15BD471SH1□	470Ω±25%	200mA	200mA	0.6Ω
BLM15BD601SZ1□	BLM15BD601SH1□	600Ω±25%	200mA	200mA	0.65Ω
BLM15BD102SZ1□	BLM15BD102SH1□	1000Ω±25%	200mA	200mA	0.9Ω
BLM15BD152SZ1□	—	1500Ω±25%	190mA	190mA	1Ω
BLM15BD182SZ1□	BLM15BD182SH1□	1800Ω±25%	100mA/200mA	100mA/200mA	1.4Ω

Operating Temp. Range: -55°C to 125°C

### Z-f characteristics

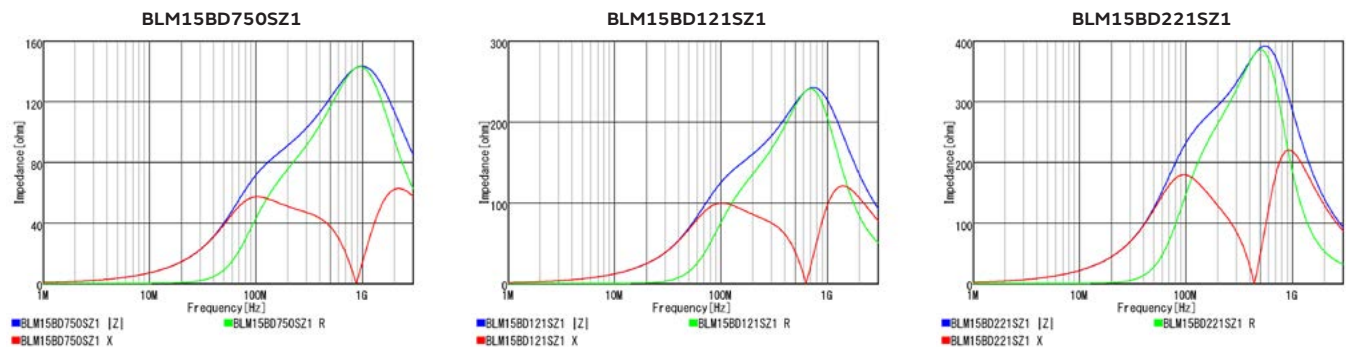

Continued on the following page. ↗

Continued from the preceding page. ↘

## Z-f characteristics

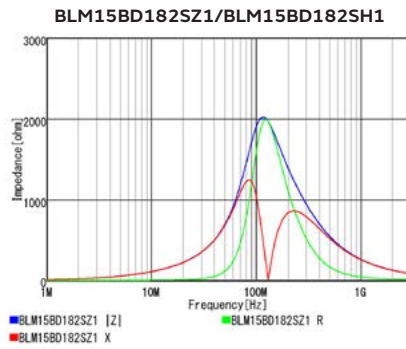
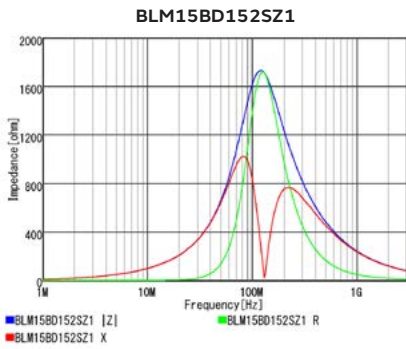
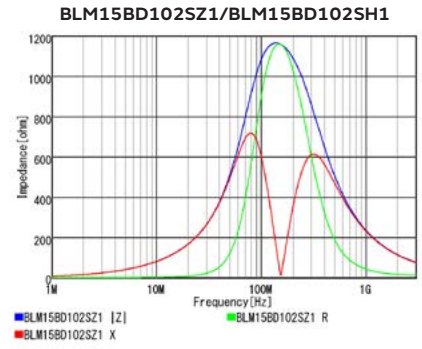
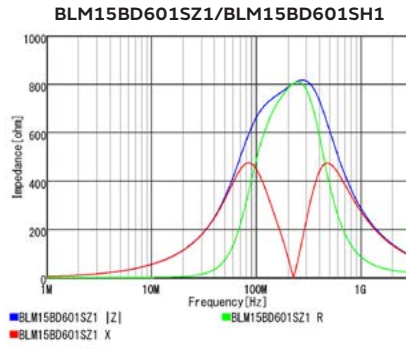
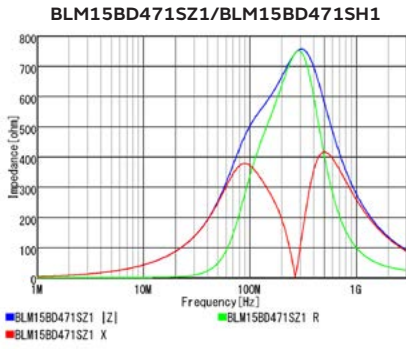

Chip Ferrite Bead

Chip EMIFIL

Chip Common Mode Choke Coil

Block Type EMIFIL

Microchip Transformer (Balun)

Inductors for Power Lines

Inductors for General Circuits

RF Inductors

# Chip Ferrite Bead SMD Type

## BLM15BX Series 0402/1005(inch/mm)

### Specifications Sheet (with cautions/mounting/packaging)

Infotainment	<a href="https://www.murata.com/products/productdata/8796200173598/QNFA9118.pdf?1613016712000">https://www.murata.com/products/productdata/8796200173598/QNFA9118.pdf?1613016712000</a>
Powertrain/Safety	—

### Appearance/Dimensions

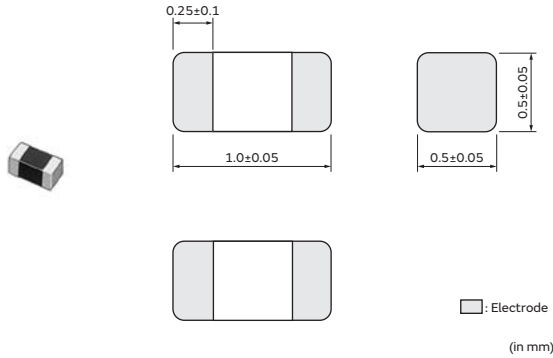

### Packaging

Code	Packaging	Minimum Quantity
D	ø180mm Paper Tape	10000
J	ø330mm Paper Tape	50000
B	Bulk(Bag)	1000

### Equivalent Circuit



(Resistance element becomes dominant at high frequencies.)

### Rated Value (□: packaging code)

Part Number		Impedance at 100MHz	Rated Current at 85°C	Rated Current at 125°C	DC Resistance (Max.)
Infotainment	Powertrain/Safety				
BLM15BX750SZ1□	—	75Ω±25%	600mA	600mA	0.15Ω
BLM15BX121SZ1□	—	120Ω±25%	600mA	600mA	0.17Ω
BLM15BX221SZ1□	—	220Ω±25%	450mA	450mA	0.27Ω
BLM15BX471SZ1□	—	470Ω±25%	350mA	350mA	0.41Ω
BLM15BX601SZ1□	—	600Ω±25%	350mA	350mA	0.46Ω
BLM15BX102SZ1□	—	1000Ω±25%	300mA	300mA	0.65Ω
BLM15BX182SZ1□	—	1800Ω±25%	250mA	250mA	0.9Ω

Operating Temp. Range: -55°C to 125°C

### Z-f characteristics

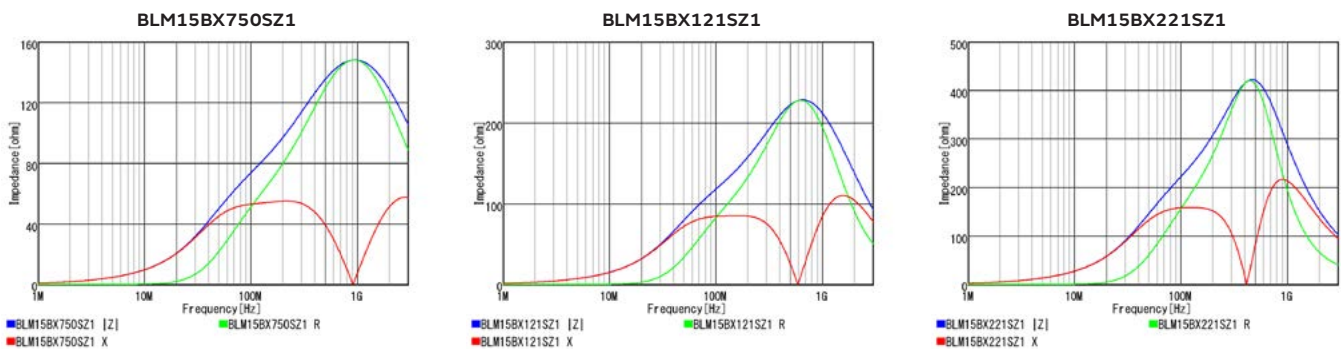

Continued on the following page. ↗

Continued from the preceding page. ↘

## Z-f characteristics

**BLM15BX471SZ1**

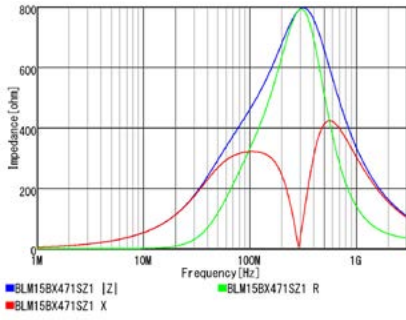

**BLM15BX601SZ1**

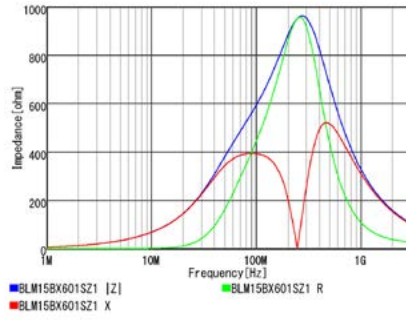

**BLM15BX102SZ1**

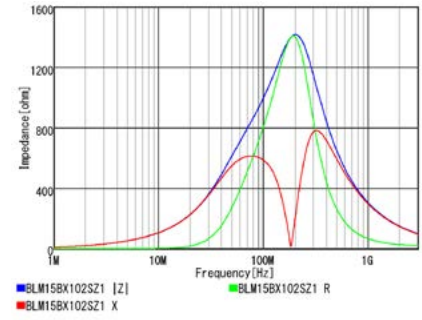

**BLM15BX182SZ1**

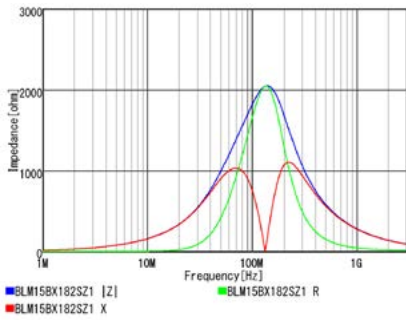

Chip Ferrite Bead

Chip EMIFIL

Chip Common Mode Choke Coil

Block Type EMIFIL

Microchip Transformer (Balun)

Inductors for Power Lines

Inductors for General Circuits

RF Inductors

# Chip Ferrite Bead SMD Type

## BLM15HB Series 0402/1005(inch/mm)

### Specifications Sheet (with cautions/mounting/packaging)

Infotainment	<a href="https://www.murata.com/products/productdata/8796200271902/QNFA9121.pdf?1558395620000">https://www.murata.com/products/productdata/8796200271902/QNFA9121.pdf?1558395620000</a>
Powertrain/Safety	<a href="https://www.murata.com/products/productdata/8796199354398/QNFA9111.pdf?1613016712000">https://www.murata.com/products/productdata/8796199354398/QNFA9111.pdf?1613016712000</a>

### Appearance/Dimensions

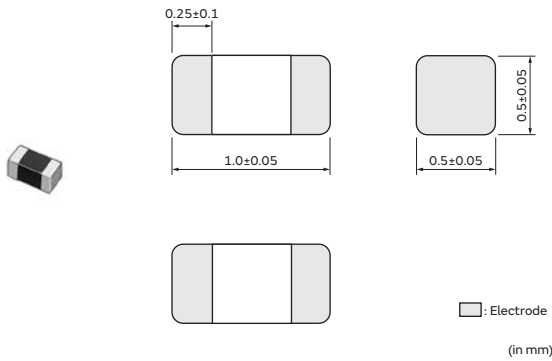

### Packaging

Code	Packaging	Minimum Quantity
D	ø180mm Paper Tape	10000
J	ø330mm Paper Tape	50000
B	Bulk(Bag)	1000

### Equivalent Circuit

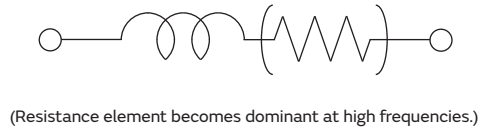

### Rated Value (□: packaging code)

Part Number		Impedance at 100MHz	Impedance at 1GHz	Rated Current at 85°C	Rated Current at 125°C	DC Resistance (Max.)
Infotainment	Powertrain/Safety					
BLM15HB121SZ1□	BLM15HB121SH1□	120Ω±25%	500Ω±40%	300mA	300mA	0.7Ω
BLM15HB221SZ1□	BLM15HB221SH1□	220Ω±25%	900Ω±40%	250mA	250mA	1Ω

Operating Temp. Range: -55°C to 125°C

### Z-f characteristics

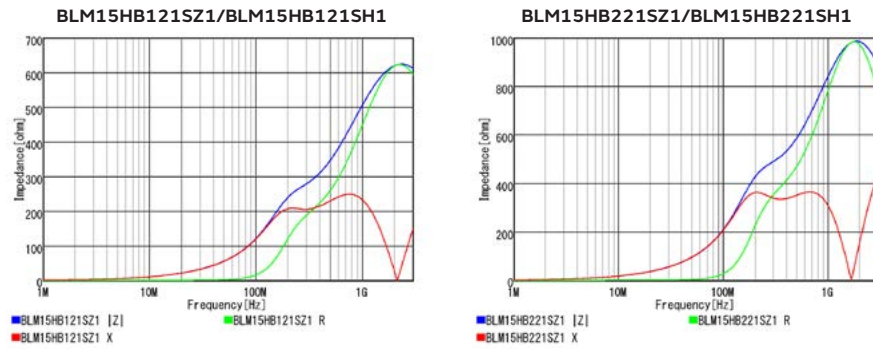

Chip Ferrite Bead

Chip EMI/FIL

Chip Common Mode Choke Coil

Block Type EMI/FIL

Microchip Transformer (Balun)

Inductors for Power Lines

Inductors for General Circuits

RF Inductors



# Chip Ferrite Bead SMD Type

## BLM15HD Series 0402/1005(inch/mm)

### Specifications Sheet (with cautions/mounting/packaging)

Infotainment	<a href="https://www.murata.com/products/productdata/8796200271902/QNFA9121.pdf?1558395620000">https://www.murata.com/products/productdata/8796200271902/QNFA9121.pdf?1558395620000</a>
Powertrain/Safety	<a href="https://www.murata.com/products/productdata/8796199354398/QNFA9111.pdf?1613016712000">https://www.murata.com/products/productdata/8796199354398/QNFA9111.pdf?1613016712000</a>

### Appearance/Dimensions

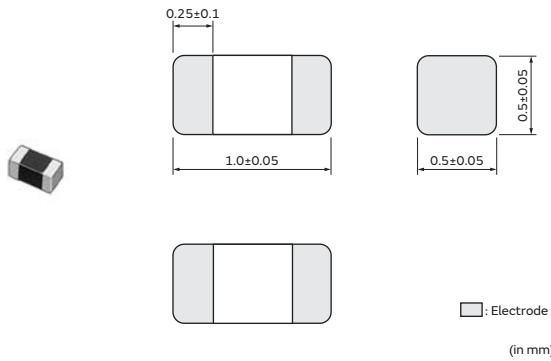

### Packaging

Code	Packaging	Minimum Quantity
D	ø180mm Paper Tape	10000
J	ø330mm Paper Tape	50000
B	Bulk(Bag)	1000

### Equivalent Circuit



(Resistance element becomes dominant at high frequencies.)

### Rated Value (□: packaging code)

Part Number		Impedance at 100MHz	Impedance at 1GHz	Rated Current at 85°C	Rated Current at 125°C	DC Resistance (Max.)
Infotainment	Powertrain/Safety					
BLM15HD601SZ1□	BLM15HD601SH1□	600Ω±25%	1400Ω±40%	300mA	300mA	0.85Ω
BLM15HD102SZ1□	BLM15HD102SH1□	1000Ω±25%	2000Ω±40%	250mA	250mA	1.25Ω
BLM15HD182SZ1□	BLM15HD182SH1□	1800Ω±25%	2700Ω±40%	200mA	200mA	2.2Ω

Operating Temp. Range: -55°C to 125°C

### Z-f characteristics

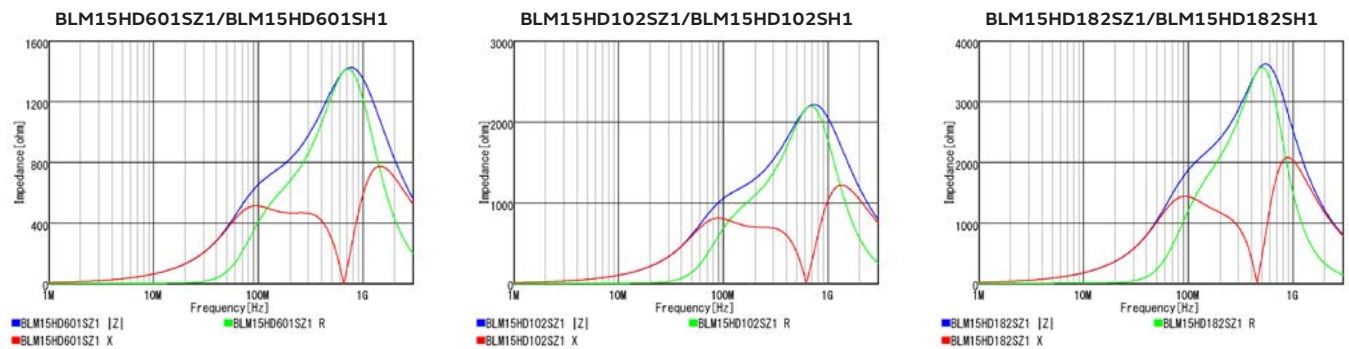

# Chip Ferrite Bead SMD Type

## BLM15HD(150°C Available) Series 0402/1005(inch/mm)

### Specifications Sheet (with cautions/mounting/packaging)

Infotainment	—
Powertrain/Safety	<a href="https://www.murata.com/products/productdata/8799740952606/QNFA9137.pdf?1605660805000">https://www.murata.com/products/productdata/8799740952606/QNFA9137.pdf?1605660805000</a>

### Appearance/Dimensions

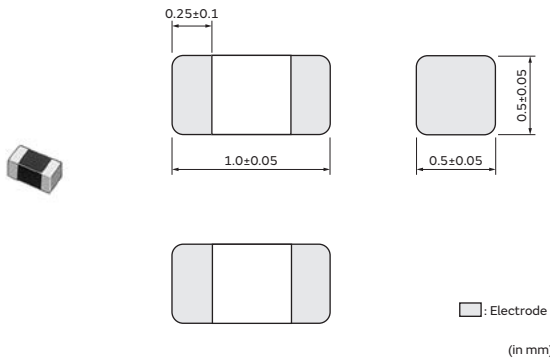

### Packaging

Code	Packaging	Minimum Quantity
D	ø180mm Paper Tape	10000
J	ø330mm Paper Tape	50000
B	Bulk(Bag)	1000

### Equivalent Circuit

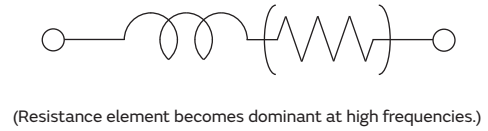

### Rated Value (□: packaging code)

Part Number		Impedance at 100MHz	Impedance at 1GHz	DC Resistance (Max.)
Infotainment	Powertrain/Safety			
—	BLM15HD601BH1□	600Ω±25%	1400Ω±40%	0.85Ω
—	BLM15HD102BH1□	1000Ω±25%	2000Ω±40%	1.25Ω
—	BLM15HD182BH1□	1800Ω±25%	2700Ω±40%	2Ω

Rated Current at 150°C: 20mA  
 Operating Temp. Range: -55°C to 150°C

### Z-f characteristics

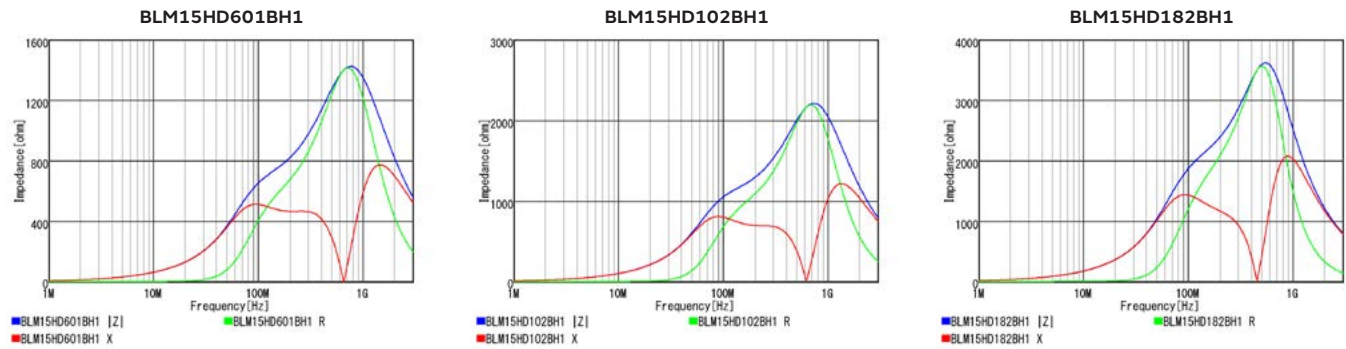

Continued on the following page. ↗

Continued from the preceding page. ↘

## Derating of Rated Current

In operating temperature exceeding +125°C, derating of current is necessary for this series.  
Please apply the derating curve shown in chart according to the operating temperature.

### Derating of Rated Current

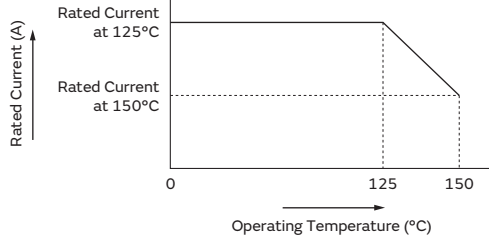

Chip Ferrite Bead

Chip EMIFIL

Chip Common Mode Choke Coil

Block Type EMIFIL

Microchip Transformer (Balun)

Inductors for Power Lines

Inductors for General Circuits

RF Inductors

# Chip Ferrite Bead SMD Type

## BLM15HG Series 0402/1005(inch/mm)

### Specifications Sheet (with cautions/mounting/packaging)

Infotainment	<a href="https://www.murata.com/products/productdata/8796200271902/QNFA9121.pdf?1558395620000">https://www.murata.com/products/productdata/8796200271902/QNFA9121.pdf?1558395620000</a>
Powertrain/Safety	<a href="https://www.murata.com/products/productdata/8796199354398/QNFA9111.pdf?1613016712000">https://www.murata.com/products/productdata/8796199354398/QNFA9111.pdf?1613016712000</a>

### Appearance/Dimensions

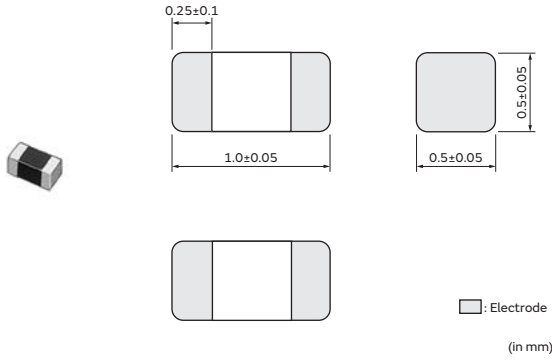

### Packaging

Code	Packaging	Minimum Quantity
D	ø180mm Paper Tape	10000
J	ø330mm Paper Tape	50000
B	Bulk(Bag)	1000

### Equivalent Circuit

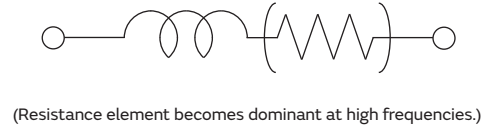

### Rated Value (□: packaging code)

Part Number		Impedance at 100MHz	Impedance at 1GHz	Rated Current at 85°C	Rated Current at 125°C	DC Resistance (Max.)
Infotainment	Powertrain/Safety					
BLM15HG601SZ1□	BLM15HG601SH1□	600Ω±25%	1000Ω±40%	300mA	300mA	0.7Ω
BLM15HG102SZ1□	BLM15HG102SH1□	1000Ω±25%	1400Ω±40%	250mA	250mA	1.1Ω

Operating Temp. Range: -55°C to 125°C

### Z-f characteristics

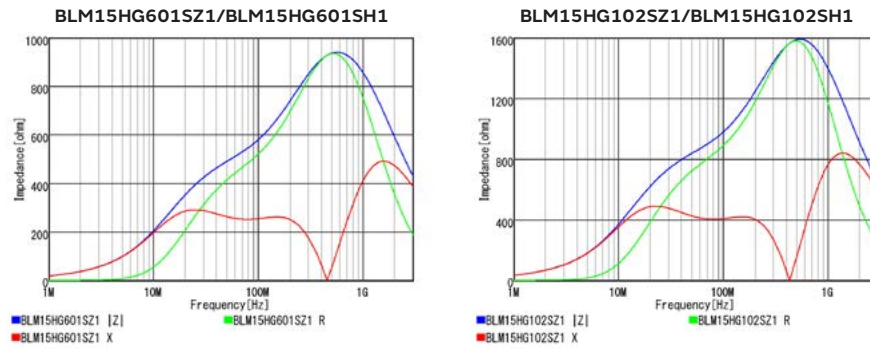

# Chip Ferrite Bead SMD Type

## BLM15HG(150°C Available) Series 0402/1005(inch/mm)

### Specifications Sheet (with cautions/mounting/packaging)

Infotainment	—
Powertrain/Safety	<a href="https://www.murata.com/products/productdata/8799740952606/QNFA9137.pdf?1605660805000">https://www.murata.com/products/productdata/8799740952606/QNFA9137.pdf?1605660805000</a>

### Appearance/Dimensions

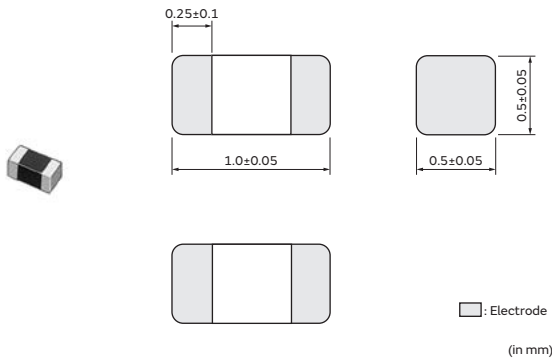

### Packaging

Code	Packaging	Minimum Quantity
D	ø180mm Paper Tape	10000
J	ø330mm Paper Tape	50000
B	Bulk(Bag)	1000

### Equivalent Circuit



(Resistance element becomes dominant at high frequencies.)

### Rated Value (□: packaging code)

Part Number		Impedance at 100MHz	Impedance at 1GHz	Rated Current at 85°C	DC Resistance (Max.)
Infotainment	Powertrain/Safety				
—	BLM15HG601BH1□	600Ω±25%	1000Ω±40%	300mA	0.7Ω
—	BLM15HG102BH1□	1000Ω±25%	1400Ω±40%	250mA	1.1Ω

Rated Current at 150°C: 20mA  
 Operating Temp. Range: -55°C to 150°C

### Z-f characteristics

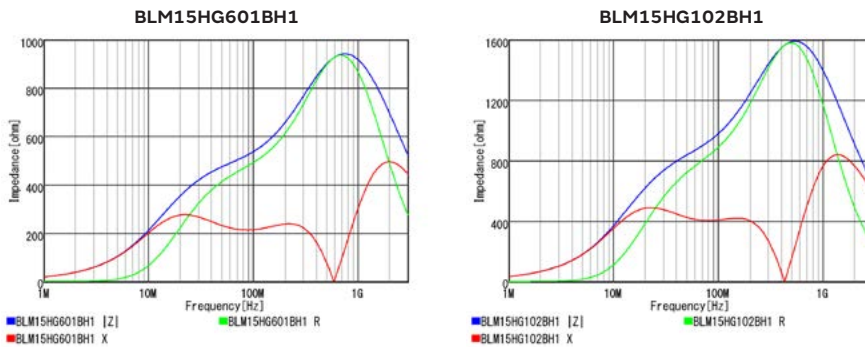

Continued on the following page. ↗

Continued from the preceding page. ↘

## Derating of Rated Current

In operating temperature exceeding +125°C, derating of current is necessary for BLM15HG series.  
Please apply the derating curve shown in chart according to the operating temperature.

Derating of Rated Current

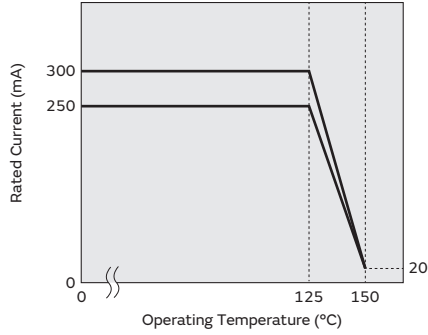

Chip Ferrite Bead  
 Chip EMI/FIL  
 Chip Common Mode Choke Coil  
 Block Type EMI/FIL  
 Microchip Transformer (Ballun)  
 Inductors for Power Lines  
 Inductors for General Circuits  
 RF Inductors

# Chip Ferrite Bead SMD Type

## BLM15EG Series 0402/1005(inch/mm)

### Specifications Sheet (with cautions/mounting/packaging)

Infotainment	<a href="https://www.murata.com/products/productdata/8796200206366/QNFA9119.pdf?1558395620000">https://www.murata.com/products/productdata/8796200206366/QNFA9119.pdf?1558395620000</a>
Powertrain/Safety	<a href="https://www.murata.com/products/productdata/8799740887070/QNFA9136.pdf?156643330000">https://www.murata.com/products/productdata/8799740887070/QNFA9136.pdf?156643330000</a>

### Appearance/Dimensions

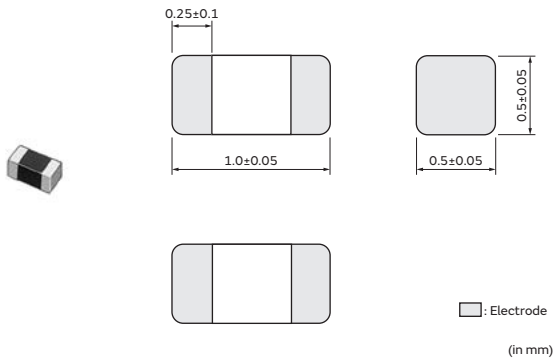

### Packaging

Code	Packaging	Minimum Quantity
D	ø180mm Paper Tape	10000
J	ø330mm Paper Tape	50000
B	Bulk(Bag)	1000

### Equivalent Circuit



(Resistance element becomes dominant at high frequencies.)

### Rated Value (□: packaging code)

Part Number		Impedance at 100MHz	Impedance at 1GHz	Rated Current at 85°C	Rated Current at 125°C	DC Resistance (Max.)
Infotainment	Powertrain/Safety					
BLM15EG121SZ1□	BLM15EG121SH1□	120Ω±25%	145Ω(Typ.)	1.5A	900mA	0.095Ω
BLM15EG221SZ1□	BLM15EG221SH1□	220Ω±25%	270Ω(Typ.)	700mA	500mA	0.28Ω

Operating Temp. Range: -55°C to 125°C

### Z-f characteristics

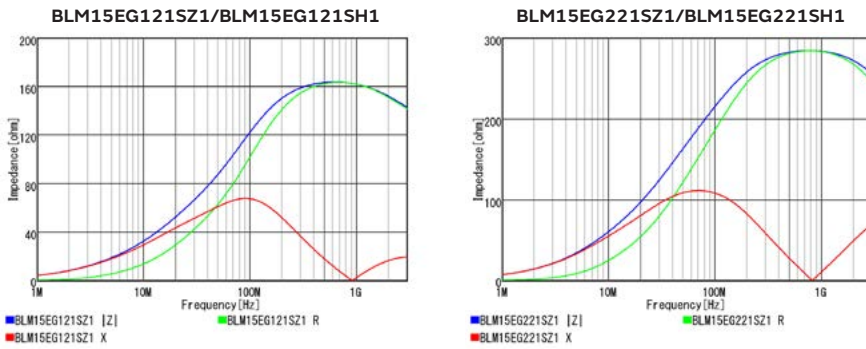

Continued on the following page. ↗



Continued from the preceding page. ↘

## Derating of Rated Current

In operating temperature exceeding +85°C, derating of current is necessary for BLM15E series. Please apply the derating curve shown in chart according to the operating temperature.

Derating of Rated Current

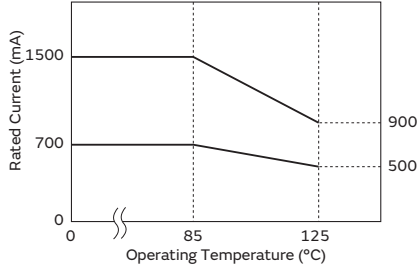

# Chip Ferrite Bead SMD Type

## BLM15GA Series 0402/1005(inch/mm)

### Specifications Sheet (with cautions/mounting/packaging)

Infotainment	<a href="https://www.murata.com/products/productdata/8796200239134/QNFA9120.pdf?1545716739000">https://www.murata.com/products/productdata/8796200239134/QNFA9120.pdf?1545716739000</a>
Powertrain/Safety	—

### Appearance/Dimensions

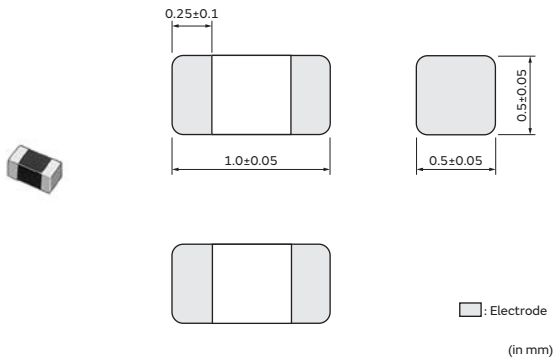

### Packaging

Code	Packaging	Minimum Quantity
D	ø180mm Paper Tape	10000
J	ø330mm Paper Tape	50000
B	Bulk(Bag)	1000

### Equivalent Circuit



(Resistance element becomes dominant at high frequencies.)

### Rated Value (□: packaging code)

Part Number		Impedance at 100MHz	Impedance at 1GHz	Rated Current at 85°C	Rated Current at 125°C	DC Resistance (Max.)	Operating Temp. Range
Infotainment	Powertrain/Safety						
BLM15GA750SZ1□	—	75Ω±25%	1000Ω±40%	200mA	200mA	1.3Ω	-55°C to 125°C

### Z-f characteristics

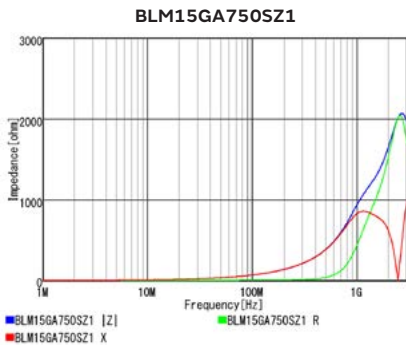

# Chip Ferrite Bead SMD Type

## BLM15GG Series 0402/1005(inch/mm)

### Specifications Sheet (with cautions/mounting/packaging)

Infotainment	<a href="https://www.murata.com/products/productdata/8796200239134/QNFA9120.pdf?1545716739000">https://www.murata.com/products/productdata/8796200239134/QNFA9120.pdf?1545716739000</a>
Powertrain/Safety	—

### Appearance/Dimensions

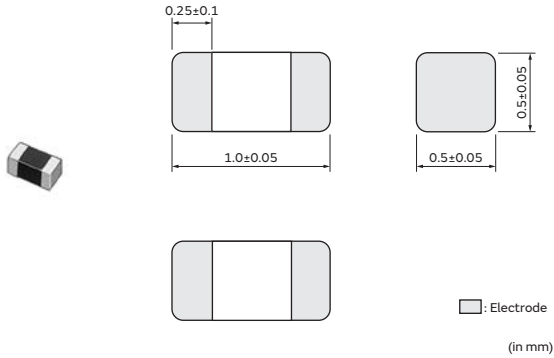

### Packaging

Code	Packaging	Minimum Quantity
D	ø180mm Paper Tape	10000
J	ø330mm Paper Tape	50000
B	Bulk(Bag)	1000

### Equivalent Circuit

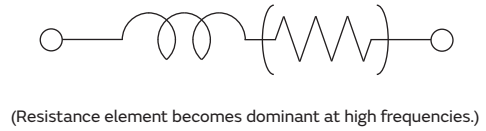

### Rated Value (□: packaging code)

Part Number		Impedance at 100MHz	Impedance at 1GHz	Rated Current at 85°C	Rated Current at 125°C	DC Resistance (Max.)
Infotainment	Powertrain/Safety					
BLM15GG221SZ1□	—	220Ω±25%	600Ω±40%	300mA	300mA	0.7Ω
BLM15GG471SZ1□	—	470Ω±25%	1200Ω±40%	200mA	200mA	1.3Ω

Operating Temp. Range: -55°C to 125°C

### Z-f characteristics

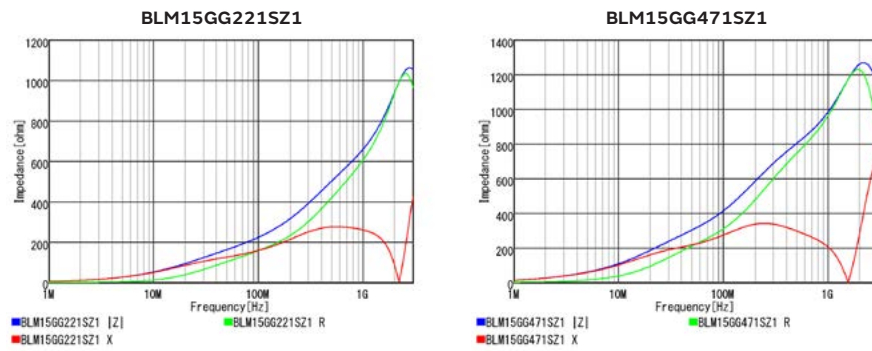

# Chip Ferrite Bead SMD Type

## BLM18PG Series 0603/1608(inch/mm)

### Specifications Sheet (with cautions/mounting/packaging)

Infotainment	<a href="https://www.murata.com/products/productdata/8796200304670/QNFA9122.pdf?1615959120000">https://www.murata.com/products/productdata/8796200304670/QNFA9122.pdf?1615959120000</a>
Powertrain/Safety	<a href="https://www.murata.com/products/productdata/8796199485470/QNFA9101.pdf?1608273989000">https://www.murata.com/products/productdata/8796199485470/QNFA9101.pdf?1608273989000</a>

### Appearance/Dimensions

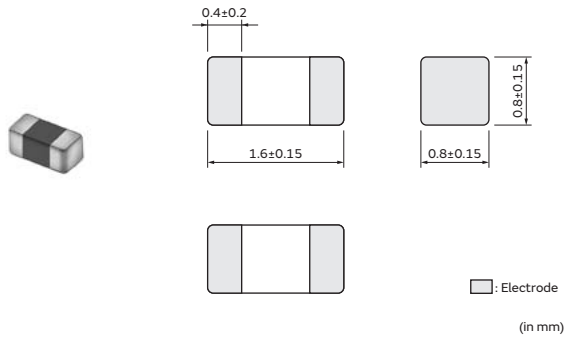

### Packaging

Code	Packaging	Minimum Quantity
D	ø180mm Paper Tape	4000
J	ø330mm Paper Tape	10000
B	Bulk(Bag)	1000

### Equivalent Circuit

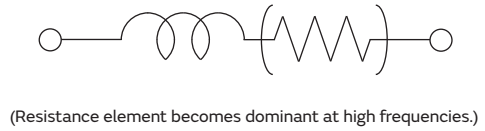

### Rated Value (□: packaging code)

Part Number		Impedance at 100MHz	Rated Current at 85°C	DC Resistance (Max.)
Infotainment	Powertrain/Safety			
BLM18PG300SZ1□	BLM18PG300SH1□	30Ω(Typ.)	1A	0.05Ω
BLM18PG330SZ1□	BLM18PG330SH1□	33Ω±25%	3A	0.025Ω
BLM18PG600SZ1□	BLM18PG600SH1□	60Ω(Typ.)	1A	0.1Ω
BLM18PG121SZ1□	BLM18PG121SH1□	120Ω±25%	2A	0.05Ω
BLM18PG181SZ1□	BLM18PG181SH1□	180Ω±25%	1.5A	0.09Ω
BLM18PG221SZ1□	BLM18PG221SH1□	220Ω±25%	1.4A	0.1Ω
BLM18PG331SZ1□	BLM18PG331SH1□	330Ω±25%	1.2A	0.15Ω
BLM18PG471SZ1□	BLM18PG471SH1□	470Ω±25%	1A	0.2Ω

Rated Current at 125°C: 1A  
 Operating Temp. Range: -55°C to 125°C

### Z-f characteristics

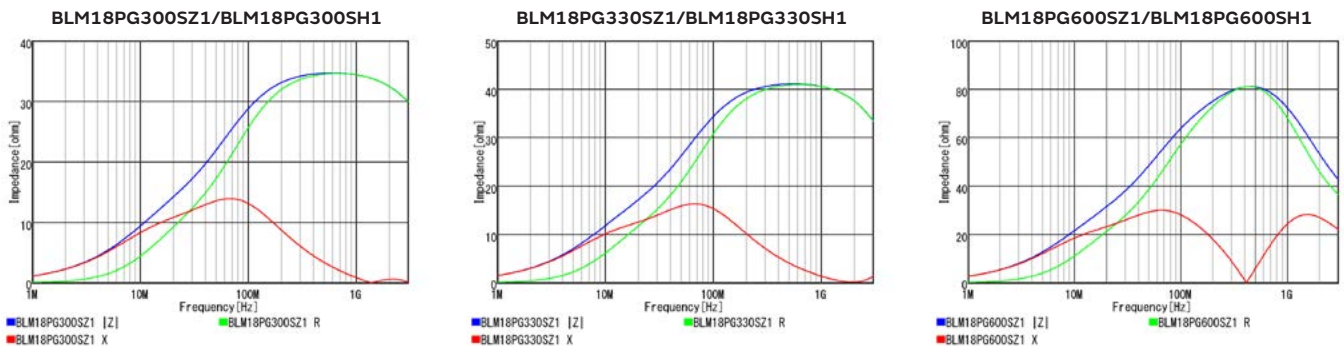

Continued on the following page. ↗

Continued from the preceding page. ↘

## Z-f characteristics

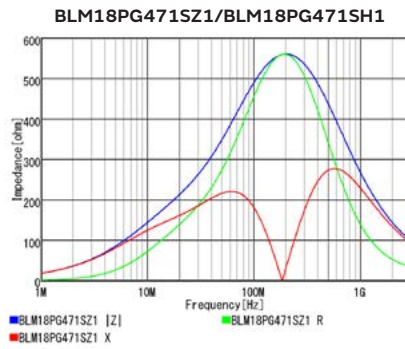
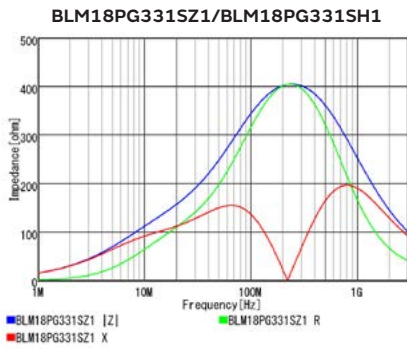
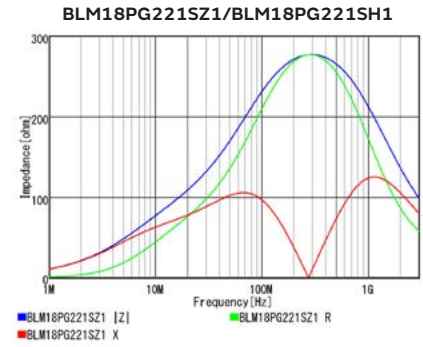
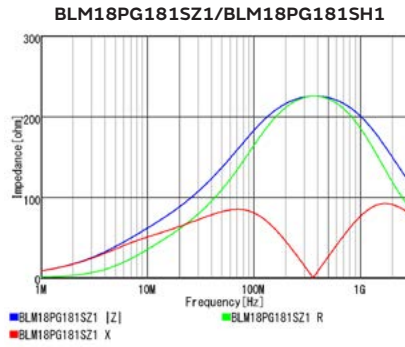
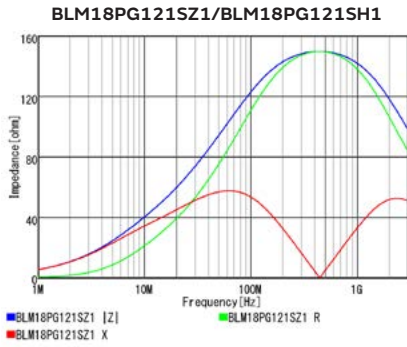

## Derating of Rated Current

In operating temperature exceeding +85°C, derating of current is necessary for BLM18PG series. Please apply the derating curve shown in chart according to the operating temperature.

Derating of Rated Current

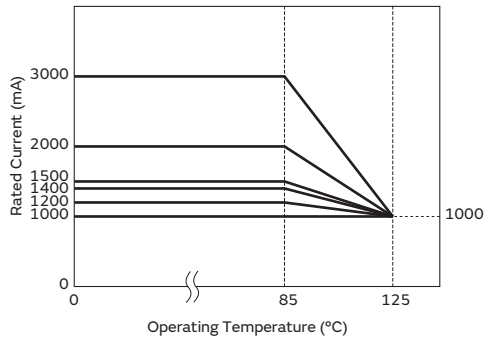

# Chip Ferrite Bead SMD Type

## BLM18SG Series 0603/1608(inch/mm)

### Specifications Sheet (with cautions/mounting/packaging)

Infotainment	<a href="https://www.murata.com/products/productdata/8796200304670/QNFA9122.pdf?1615959120000">https://www.murata.com/products/productdata/8796200304670/QNFA9122.pdf?1615959120000</a>
Powertrain/Safety	—

### Appearance/Dimensions

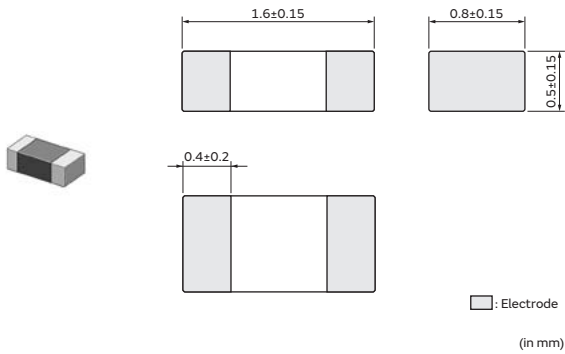

### Packaging

Code	Packaging	Minimum Quantity
D	ø180mm Paper Tape	10000
J	ø330mm Paper Tape	30000
B	Bulk(Bag)	1000

### Equivalent Circuit

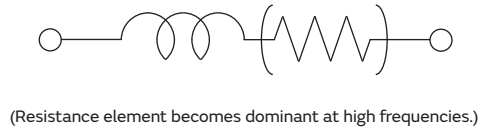

### Rated Value (□: packaging code)

Part Number		Impedance at 100MHz	Rated Current at 85°C	DC Resistance (Max.)
Infotainment	Powertrain/Safety			
BLM18SG260TZ1□	—	26Ω±25%	6A	0.007Ω
BLM18SG700TZ1□	—	70Ω±25%	4A	0.02Ω
BLM18SG121TZ1□	—	120Ω±25%	3A	0.025Ω
BLM18SG221TZ1□	—	220Ω±25%	2.5A	0.04Ω
BLM18SG331TZ1□	—	330Ω±25%	1.5A	0.07Ω

Rated Current at 125°C: 1A  
 Operating Temp. Range: -55°C to 125°C

### Z-f characteristics



Continued on the following page. ↗

Continued from the preceding page. ↘

## Z-f characteristics

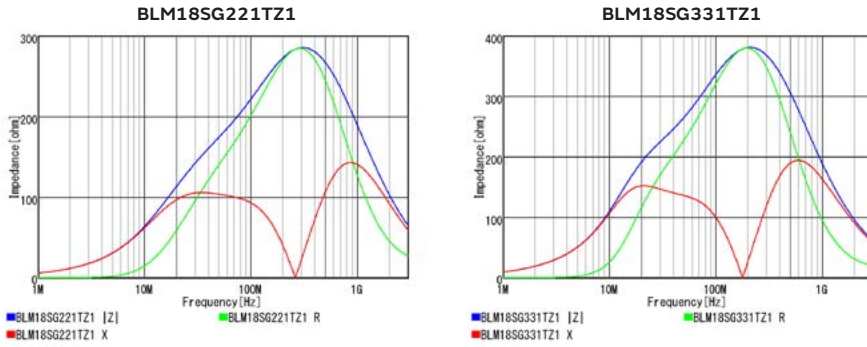

## Derating of Rated Current

In operating temperature exceeding +85°C, derating of current is necessary for BLM18SG\_T□1 series. Please apply the derating curve shown in chart according to the operating temperature.

Derating of Rated Current

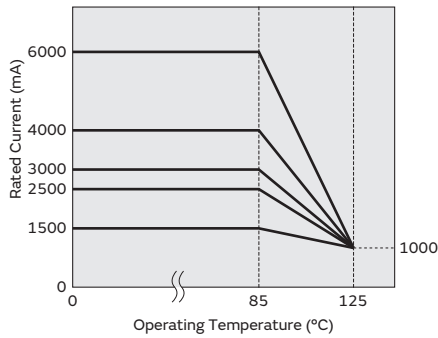



Chip Ferrite Bead  
 Chip EMIFIL  
 Chip Common Mode Choke Coil  
 Block Type EMIFIL  
 Microchip Transformer (Balun)  
 Inductors for Power Lines  
 Inductors for General Circuits  
 RF Inductors

# Chip Ferrite Bead SMD Type

## BLM18SN Series 0603/1608(inch/mm)

### Specifications Sheet (with cautions/mounting/packaging)

Infotainment	<a href="https://www.murata.com/products/productdata/8796200304670/QNFA9122.pdf?1615959120000">https://www.murata.com/products/productdata/8796200304670/QNFA9122.pdf?1615959120000</a>
Powertrain/Safety	<a href="https://www.murata.com/products/productdata/8796199485470/QNFA9101.pdf?1608273989000">https://www.murata.com/products/productdata/8796199485470/QNFA9101.pdf?1608273989000</a>

### Appearance/Dimensions

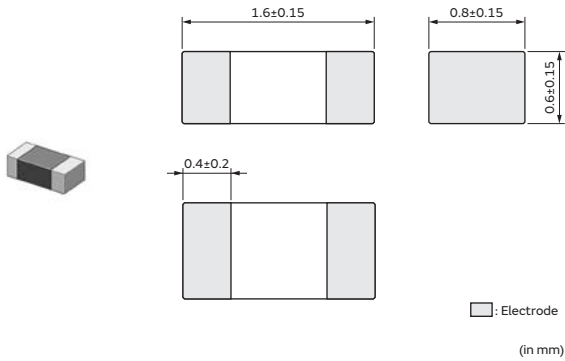

### Packaging

Code	Packaging	Minimum Quantity
D	ø180mm Paper Tape	4000
B	Bulk(Bag)	1000

### Equivalent Circuit



(Resistance element becomes dominant at high frequencies.)

### Rated Value (□: packaging code)

Part Number		Impedance at 100MHz	Rated Current at 85°C	Rated Current at 125°C	DC Resistance (Max.)	Operating Temp. Range
Infotainment	Powertrain/Safety					
<b>BLM18SN220TZ1</b> □	<b>BLM18SN220TH1</b> □	22Ω±7Ω	8A	5A	0.004Ω	-55°C to 125°C

### Z-f characteristics

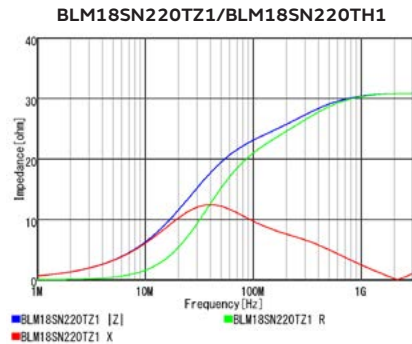

### Derating of Rated Current

In operating temperature exceeding +85°C, derating of current is necessary for BLM18SN series. Please apply the derating curve shown in chart according to the operating temperature.

#### Derating of Rated Current

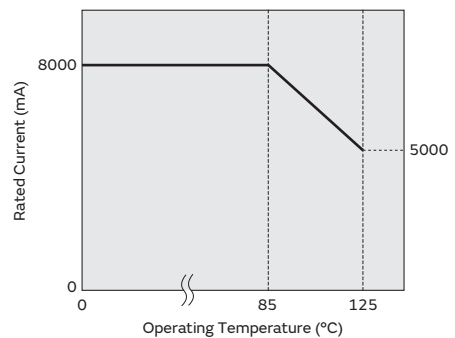

# Chip Ferrite Bead SMD Type

## BLM18SP Series 0603/1608(inch/mm)

### Specifications Sheet (with cautions/mounting/packaging)

Infotainment	<a href="https://www.murata.com/products/productdata/8796200304670/QNFA9122.pdf?1615959120000">https://www.murata.com/products/productdata/8796200304670/QNFA9122.pdf?1615959120000</a>
Powertrain/Safety	<a href="https://www.murata.com/products/productdata/8796199485470/QNFA9101.pdf?1608273989000">https://www.murata.com/products/productdata/8796199485470/QNFA9101.pdf?1608273989000</a>

### Appearance/Dimensions

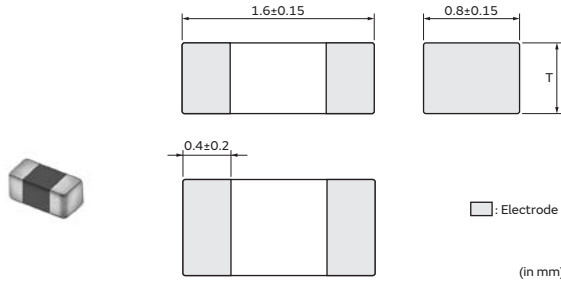

BLM18SP\_SZ1

T	Part Number	Dimension
0.5±0.15	BLM18SG***TZ1D	0.5±0.15
0.6±0.15	BLM18KG***TZ1D	0.6±0.15
0.6±0.15	BLM18SN***TZ1D	0.6±0.15
0.8±0.15	BLM18****SZ1D	0.8±0.15

### Packaging

Code	Packaging	Minimum Quantity
D	ø180mm Paper Tape	4000
B	Bulk(Bag)	1000

### Equivalent Circuit



(Resistance element becomes dominant at high frequencies.)

### Appearance/Dimensions

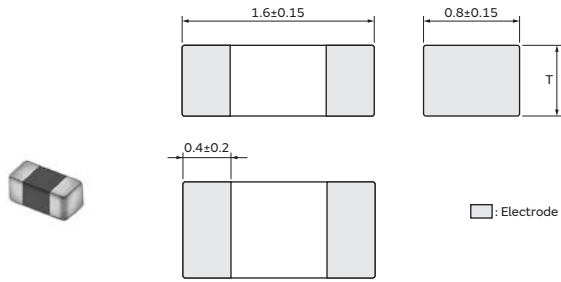

BLM18SP\_SH1

P/N	T
BLM18_SH	0.8±0.15
BLM18_TH	0.6±0.15

(in mm)

### Packaging

Code	Packaging	Minimum Quantity
D	ø180mm Paper Tape	4000
B	Bulk(Bag)	1000

### Equivalent Circuit



(Resistance element becomes dominant at high frequencies.)

### Rated Value (□: packaging code)

Part Number		Impedance at 100MHz	Rated Current at 85°C	Rated Current at 125°C	DC Resistance (Max.)
Infotainment	Powertrain/Safety				
BLM18SP300SZ1□	BLM18SP300SH1□	30Ω±10Ω	6A	4A	0.008Ω
BLM18SP101SZ1□	BLM18SP101SH1□	100Ω±25%	3.7A	2.5A	0.022Ω
BLM18SP221SZ1□	BLM18SP221SH1□	220Ω±25%	2.8A	1.9A	0.04Ω
BLM18SP601SZ1□	BLM18SP601SH1□	600Ω±25%	1.5A	1A	0.14Ω
BLM18SP102SZ1□	BLM18SP102SH1□	1000Ω±25%	1.2A	800mA	0.185Ω

Operating Temp. Range: -55°C to 125°C

Continued on the following page. ↗

Continued from the preceding page. ↘

## Z-f characteristics

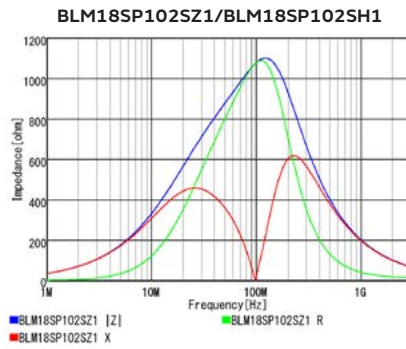
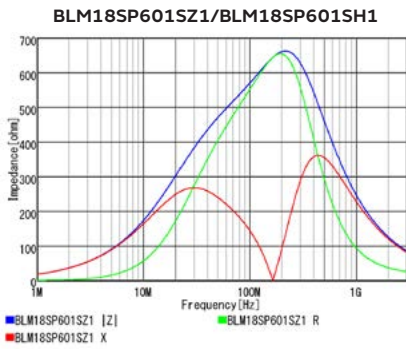
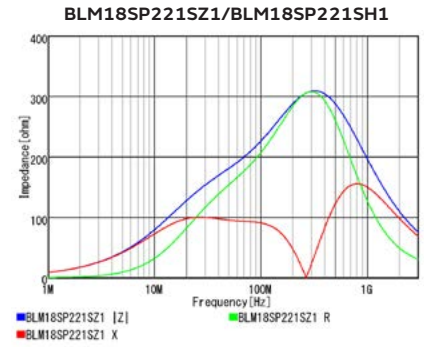
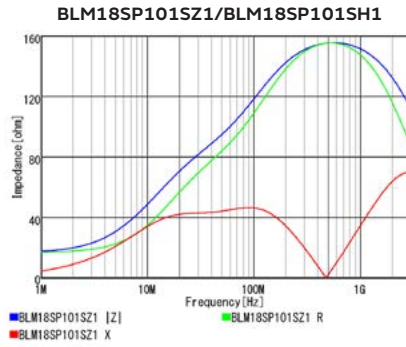
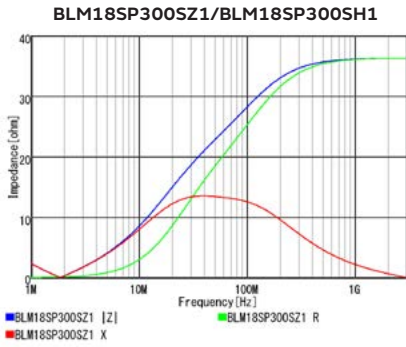

## Derating of Rated Current

In operating temperature exceeding +85°C, derating of current is necessary for this series.  
 Please apply the derating curve shown in chart according to the operating temperature.

Derating of Rated Current

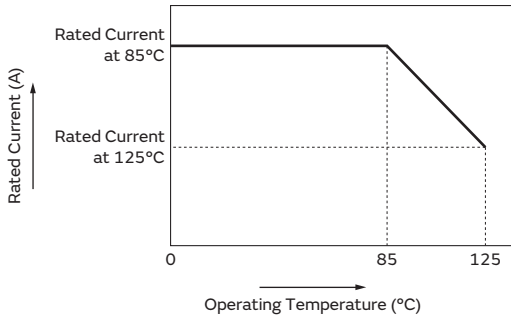

Chip Ferrite Bead

Chip EMIFIL

Chip Common Mode Choke Coil

Block Type EMIFIL

Microchip Transformer (Balun)

Inductors for Power Lines

Inductors for General Circuits

RF Inductors

# Chip Ferrite Bead SMD Type

## BLM18KG Series 0603/1608(inch/mm)

### Specifications Sheet (with cautions/mounting/packaging)

Infotainment	<a href="https://www.murata.com/products/productdata/8796200304670/QNFA9122.pdf?1615959120000">https://www.murata.com/products/productdata/8796200304670/QNFA9122.pdf?1615959120000</a>
Powertrain/Safety	<a href="https://www.murata.com/products/productdata/8796199485470/QNFA9101.pdf?1608273989000">https://www.murata.com/products/productdata/8796199485470/QNFA9101.pdf?1608273989000</a>

### Appearance/Dimensions

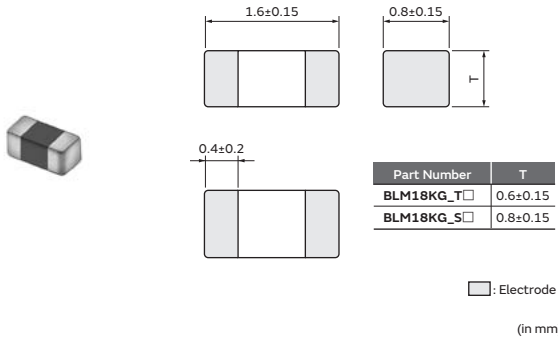

### Packaging

Code	Packaging	Minimum Quantity
D	ø180mm Paper Tape	4000
J	ø330mm Paper Tape	10000
B	Bulk(Bag)	1000

### Equivalent Circuit



(Resistance element becomes dominant at high frequencies.)

### Rated Value (□: packaging code)

Part Number		Impedance at 100MHz	Rated Current at 85°C	Rated Current at 125°C	DC Resistance (Max.)
Infotainment	Powertrain/Safety				
BLM18KG260TZ1□	BLM18KG260TH1□	26Ω±25%	6A	4A	0.007Ω
BLM18KG300TZ1□	BLM18KG300TH1□	30Ω±25%	5A	3.3A	0.01Ω
BLM18KG700TZ1□	BLM18KG700TH1□	70Ω±25%	3.5A	2.2A	0.022Ω
BLM18KG101TZ1□	BLM18KG101TH1□	100Ω±25%	3A	1.9A	0.03Ω
BLM18KG121TZ1□	BLM18KG121TH1□	120Ω±25%	3A	1.9A	0.03Ω
BLM18KG221SZ1□	BLM18KG221SH1□	220Ω±25%	2.2A	1.5A	0.05Ω
BLM18KG331SZ1□	BLM18KG331SH1□	330Ω±25%	1.7A	1.2A	0.08Ω
BLM18KG471SZ1□	BLM18KG471SH1□	470Ω±25%	1.5A	1A	0.13Ω
BLM18KG601SZ1□	BLM18KG601SH1□	600Ω±25%	1.3A	1A	0.15Ω
BLM18KG102SZ1□	BLM18KG102SH1□	1000Ω±25%	1A	800mA	0.2Ω

Operating Temp. Range: -55°C to 125°C

### Z-f characteristics

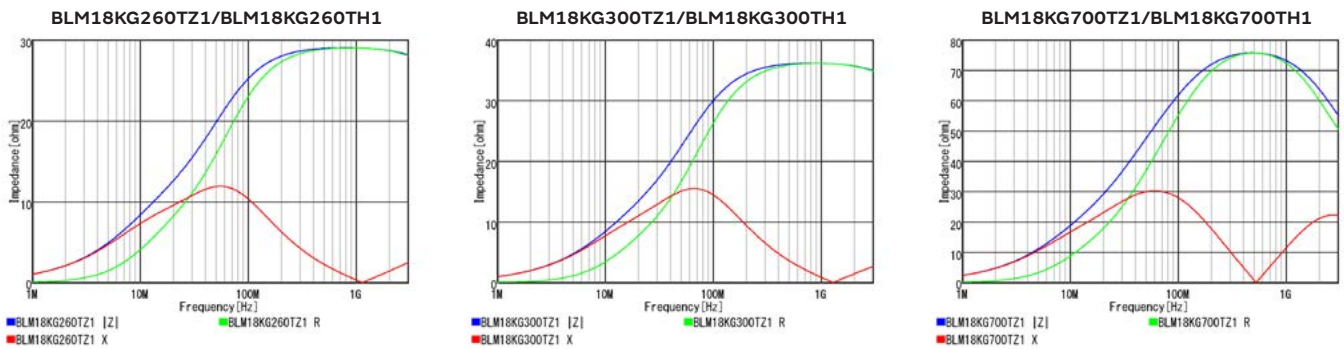

Continued on the following page. ↗

Continued from the preceding page. ↘

## Z-f characteristics

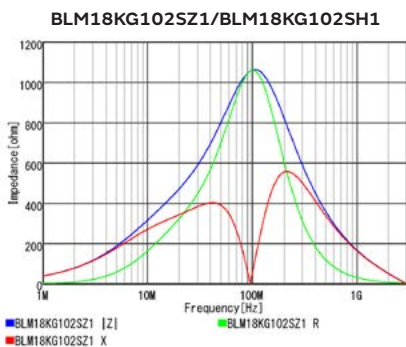
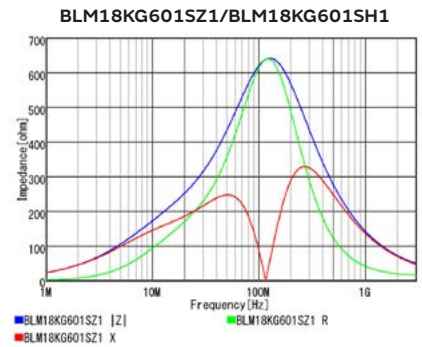
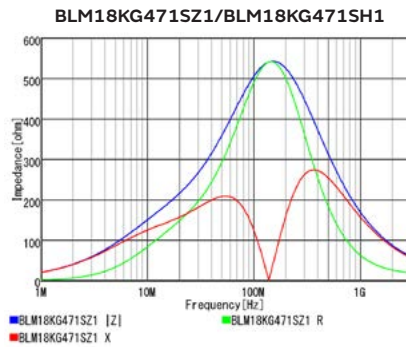
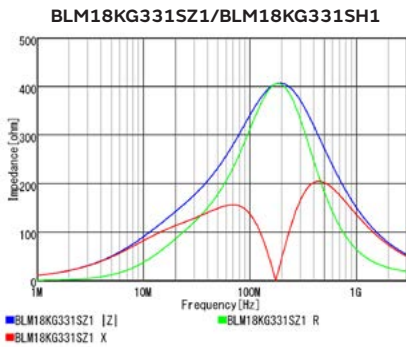
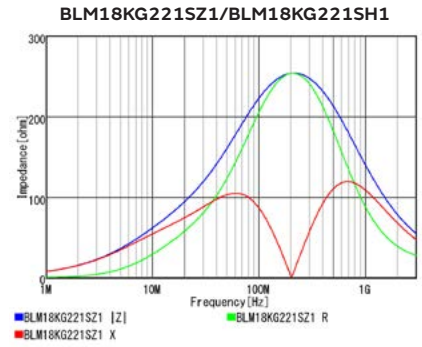
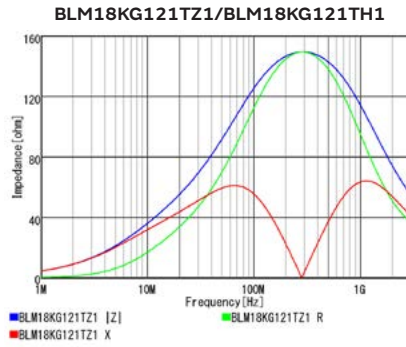
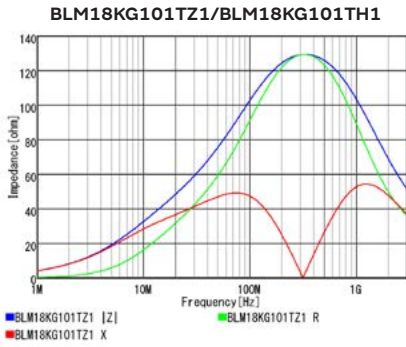

## Derating of Rated Current

In operating temperature exceeding +85°C, derating of current is necessary for BLM18KG series. Please apply the derating curve shown in chart according to the operating temperature.

Derating of Rated Current

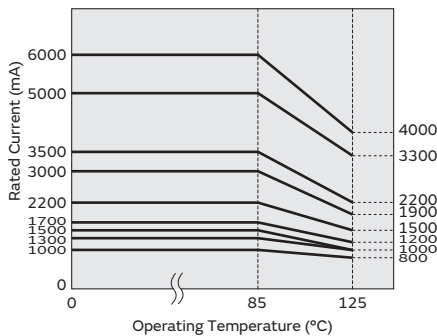

Chip Ferrite Bead  
 Chip EMIFIL  
 Chip Common Mode Choke Coil  
 Block Type EMIFIL  
 Microchip Transformer (Balun)  
 Inductors for Power Lines  
 Inductors for General Circuits  
 RF Inductors

# Chip Ferrite Bead SMD Type

## BLM18KG(150°C Available) Series 0603/1608(inch/mm)

### Specifications Sheet (with cautions/mounting/packaging)

Infotainment	—
Powertrain/Safety	<a href="https://www.murata.com/products/productdata/8798136533022/QNFA9129.pdf?1535610960000">https://www.murata.com/products/productdata/8798136533022/QNFA9129.pdf?1535610960000</a>

### Appearance/Dimensions

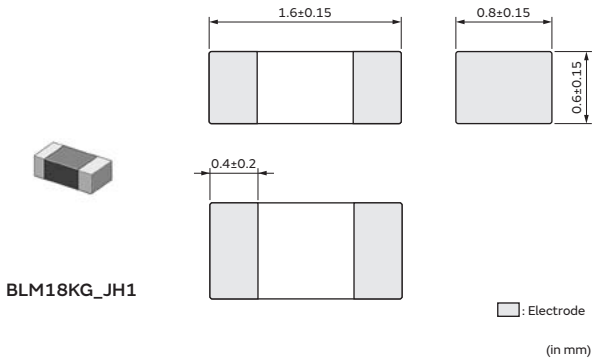

### Packaging

Code	Packaging	Minimum Quantity
D	ø180mm Paper Tape	4000
B	Bulk(Bag)	1000

### Equivalent Circuit

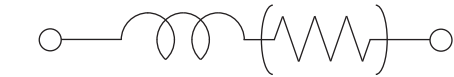

(Resistance element becomes dominant at high frequencies.)

### Appearance/Dimensions

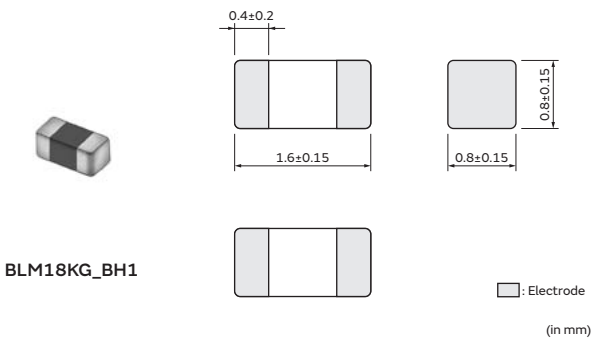

### Packaging

Code	Packaging	Minimum Quantity
D	ø180mm Paper Tape	4000
B	Bulk(Bag)	1000

### Equivalent Circuit



(Resistance element becomes dominant at high frequencies.)

### Rated Value (□: packaging code)

Part Number		Impedance at 100MHz	Rated Current at 85°C	DC Resistance (Max.)
Infotainment	Powertrain/Safety			
—	BLM18KG260JH1□	26Ω±25%	4A	0.007Ω
—	BLM18KG300JH1□	30Ω±25%	3.3A	0.01Ω
—	BLM18KG700JH1□	70Ω±25%	2.2A	0.022Ω
—	BLM18KG101JH1□	100Ω±25%	1.9A	0.03Ω
—	BLM18KG121JH1□	120Ω±25%	1.9A	0.03Ω
—	BLM18KG221BH1□	220Ω±25%	1.5A	0.05Ω
—	BLM18KG331BH1□	330Ω±25%	1.2A	0.08Ω
—	BLM18KG471BH1□	470Ω±25%	1A	0.13Ω
—	BLM18KG601BH1□	600Ω±25%	1A	0.15Ω
—	BLM18KG102BH1□	1000Ω±25%	800mA	0.2Ω

Rated Current at 150°C: 10mA  
 Operating Temp. Range: -55°C to 150°C

Continued on the following page. ↗



Continued from the preceding page. ↘

## Z-f characteristics

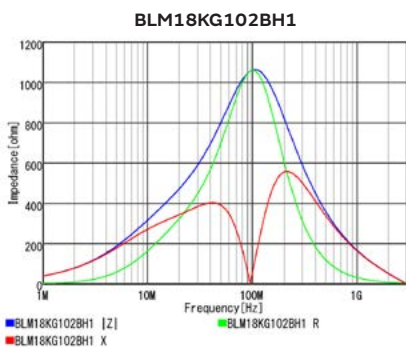
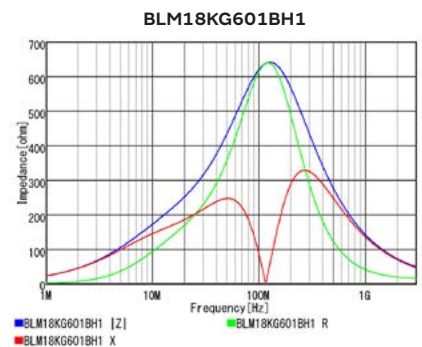
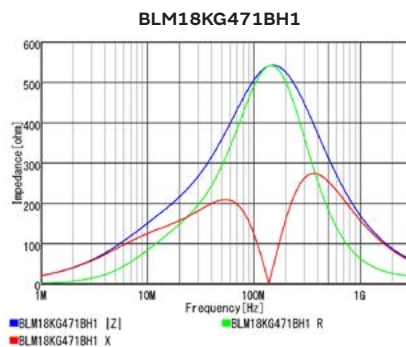
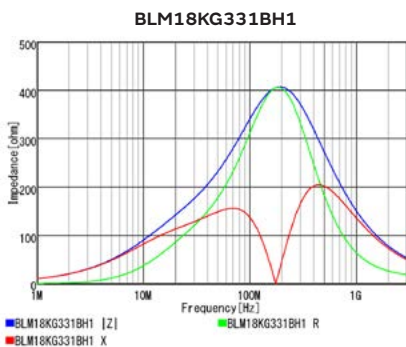
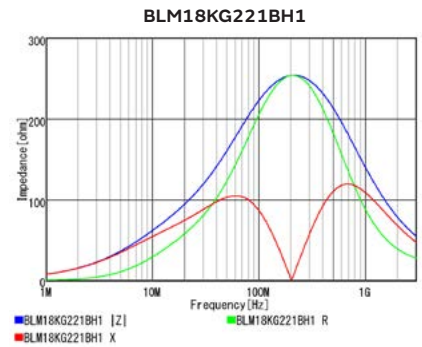
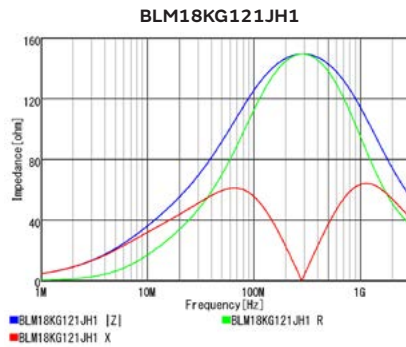
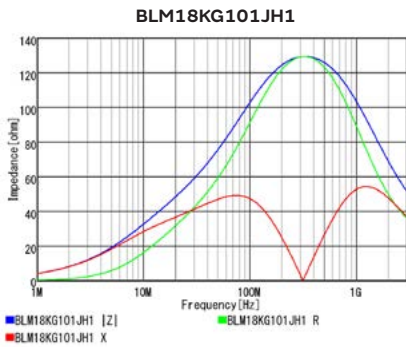
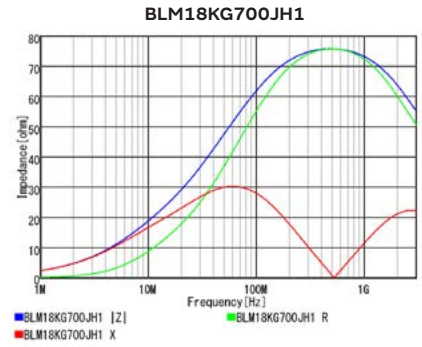
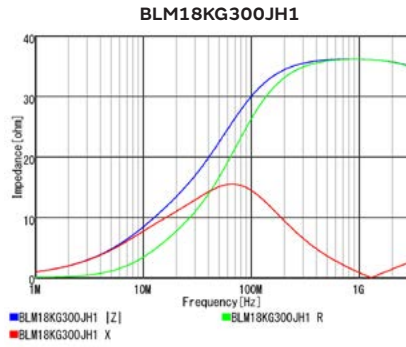
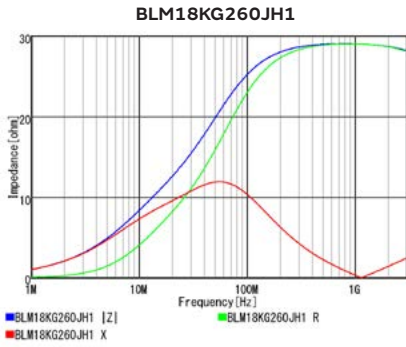

Continued on the following page. ↗

Chip Ferrite Bead  
 Chip EMIFIL  
 Chip Common Mode Choke Coil  
 Block Type EMIFIL  
 Microchip Transformer (Balun)  
 Inductors for Power Lines  
 Inductors for General Circuits  
 RF Inductors



Continued from the preceding page. ↘

## Derating of Rated Current

In operating temperature exceeding +125°C, derating of current is necessary for BLM18KG\_JH1/\_BH1 series. Please apply the derating curve shown in chart according to the operating temperature.

Derating of Rated Current

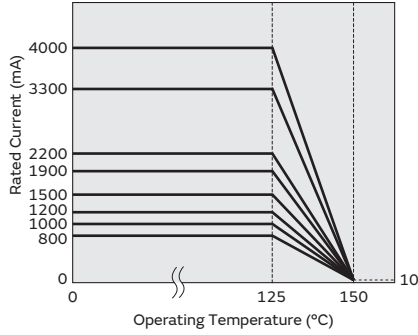

# Chip Ferrite Bead SMD Type

## BLM18KG(for conductive glue mounting) Series 0603/1608(inch/mm)

### Specifications Sheet (with cautions/mounting/packaging)

Infotainment	—
Powertrain/Safety	<a href="https://www.murata.com/products/productdata/8800912113694/QNFA9143.pdf?1615959120000">https://www.murata.com/products/productdata/8800912113694/QNFA9143.pdf?1615959120000</a>

### Appearance/Dimensions

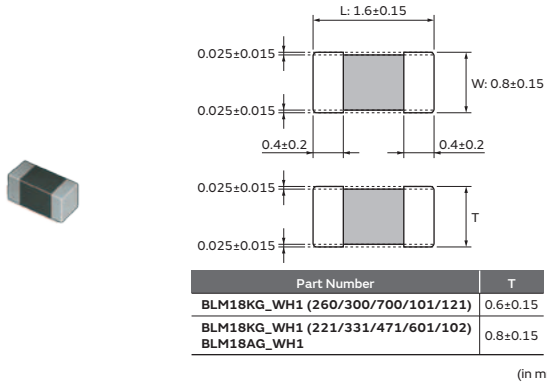

### Packaging

Code	Packaging	Minimum Quantity
D	ø180mm Paper Tape	4000
J	ø330mm Paper Tape	10000
B	Bulk(Bag)	1000

### Equivalent Circuit



(Resistance element becomes dominant at high frequencies.)

### Rated Value (□: packaging code)

Part Number		Impedance at 100MHz	Rated Current at 85°C	Rated Current at 150°C	DC Resistance (Max.)
Infotainment	Powertrain/Safety				
—	BLM18KG260WH1□	26Ω±25%	2A	1.2A	0.032Ω
—	BLM18KG300WH1□	30Ω±25%	1.85A	1.1A	0.035Ω
—	BLM18KG700WH1□	70Ω±25%	1.65A	1A	0.047Ω
—	BLM18KG101WH1□	100Ω±25%	1.5A	900mA	0.055Ω
—	BLM18KG121WH1□	120Ω±25%	1.5A	900mA	0.055Ω
—	BLM18KG221WH1□	220Ω±25%	1.4A	800mA	0.08Ω
—	BLM18KG331WH1□	330Ω±25%	1.25A	700mA	0.11Ω
—	BLM18KG471WH1□	470Ω±25%	1.1A	600mA	0.16Ω
—	BLM18KG601WH1□	600Ω±25%	1A	500mA	0.18Ω
—	BLM18KG102WH1□	1000Ω±25%	800mA	450mA	0.23Ω

Operating Temp. Range: -55°C to 150°C

### Z-f characteristics

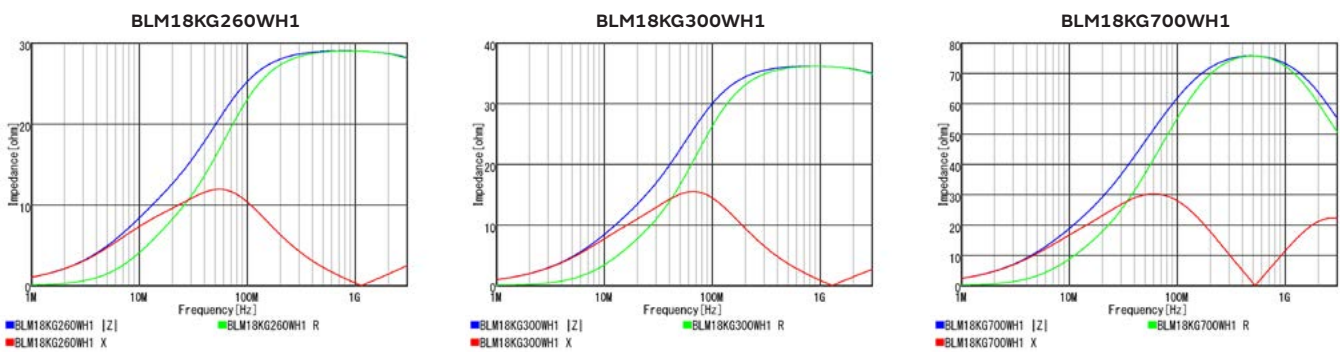

Continued on the following page. ↗

Continued from the preceding page. ↘

## Z-f characteristics

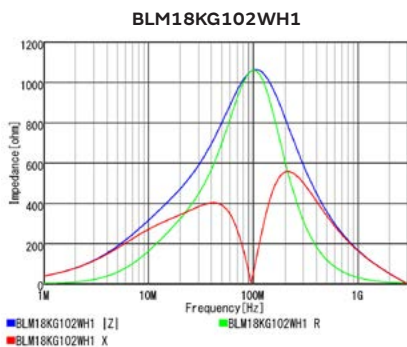
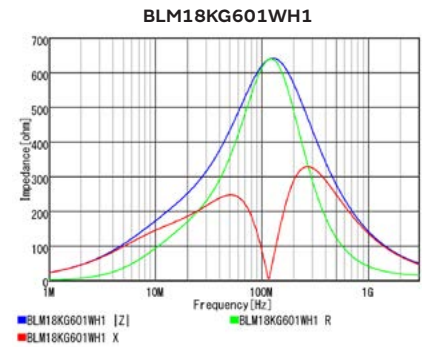
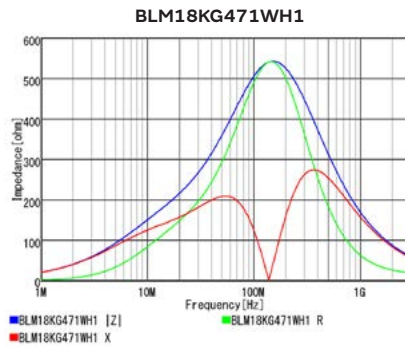
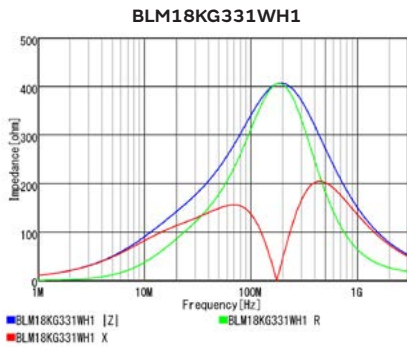
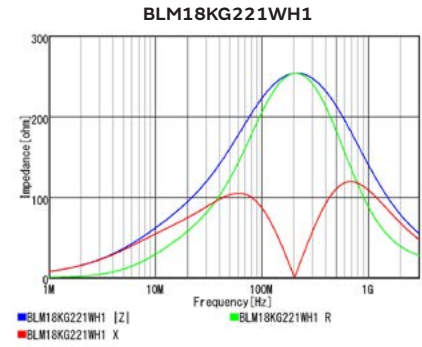
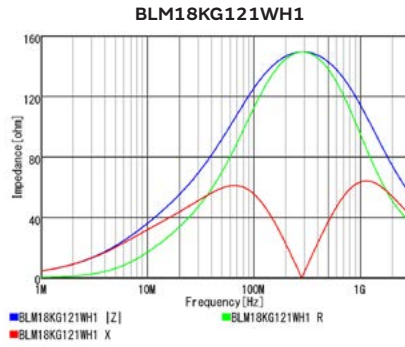
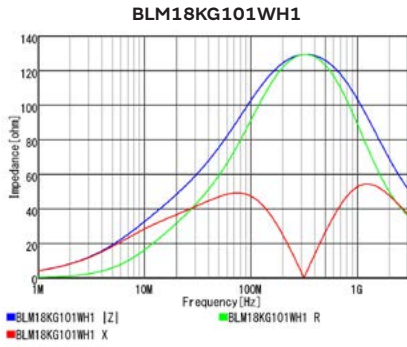

## Derating of Rated Current

In operating temperature exceeding +125°C, derating of current is necessary for BLM18KG\_WH1 series. Please apply the derating curve shown in chart according to the operating temperature.

Derating of Rated Current

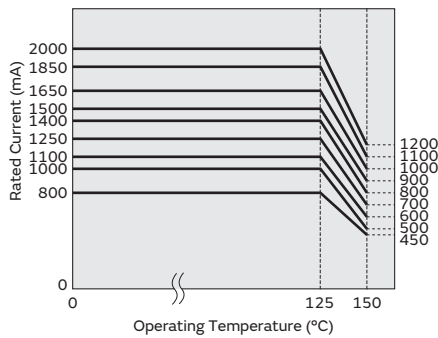

Chip Ferrite Bead  
 Chip EMIFIL  
 Chip Common Mode Choke Coil  
 Block Type EMIFIL  
 Microchip Transformer (Balun)  
 Inductors for Power Lines  
 Inductors for General Circuits  
 RF Inductors

## Chip Ferrite Bead SMD Type

# BLM18KN(175°C Available) Series 0603/1608(inch/mm)

### Specifications Sheet (with cautions/mounting/packaging)

Infotainment	—
Powertrain/Safety	<a href="https://www.murata.com/products/productdata/8809910992926/QNFA9160.pdf?1604285234000">https://www.murata.com/products/productdata/8809910992926/QNFA9160.pdf?1604285234000</a>

### Appearance/Dimensions

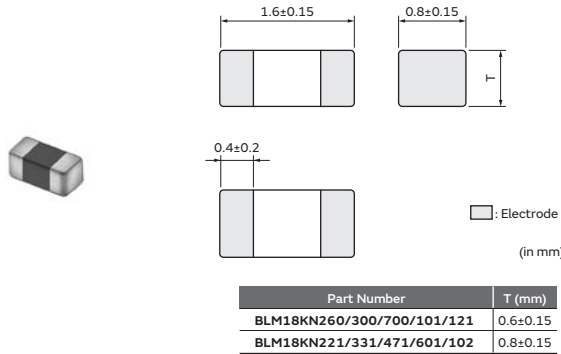

### Packaging

Code	Packaging	Minimum Quantity
D	ø180mm Paper Tape	4000
J	ø330mm Paper Tape	10000
B	Bulk(Bag)	1000

### Equivalent Circuit



(Resistance element becomes dominant at high frequencies.)

### Rated Value (□: packaging code)

Part Number		Impedance at 100MHz	DC Resistance (Max.)
Infotainment	Powertrain/Safety		
—	BLM18KN260EH1□	26Ω±25%	0.007Ω
—	BLM18KN300EH1□	30Ω±25%	0.01Ω
—	BLM18KN700EH1□	70Ω±25%	0.022Ω
—	BLM18KN101EH1□	100Ω±25%	0.03Ω
—	BLM18KN121EH1□	120Ω±25%	0.03Ω
—	BLM18KN221EH1□	220Ω±25%	0.05Ω
—	BLM18KN331EH1□	330Ω±25%	0.08Ω
—	BLM18KN471EH1□	470Ω±25%	0.13Ω
—	BLM18KN601EH1□	600Ω±25%	0.15Ω
—	BLM18KN102EH1□	1000Ω±25%	0.2Ω

Rated Current at 175°C: 10mA  
 Operating Temp. Range: -55°C to 175°C

### Z-f characteristics

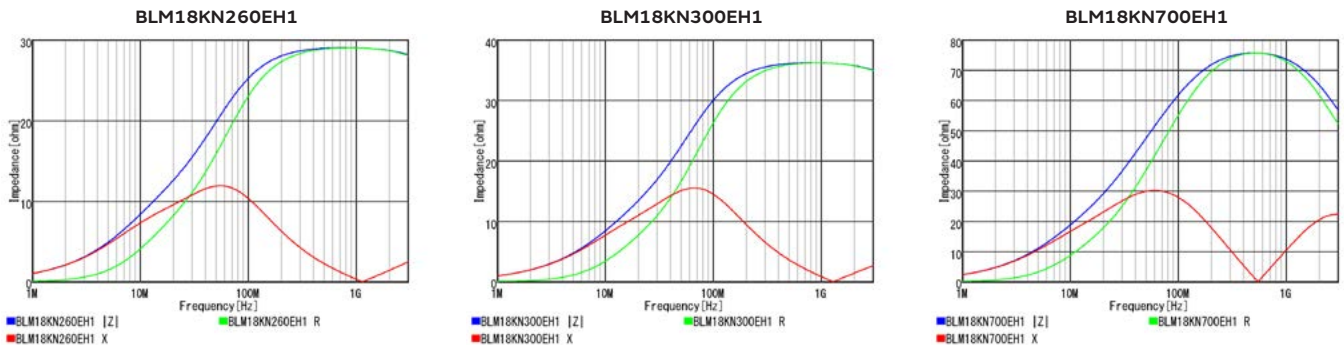

Continued on the following page. ↗

Continued from the preceding page. ↘

## Z-f characteristics

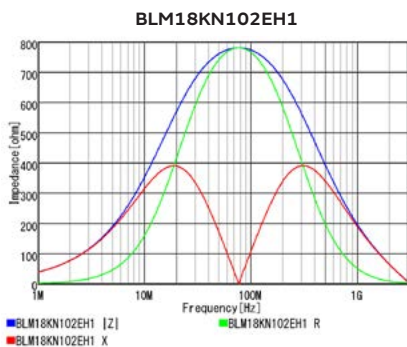
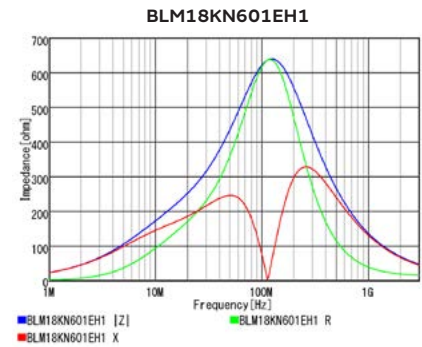
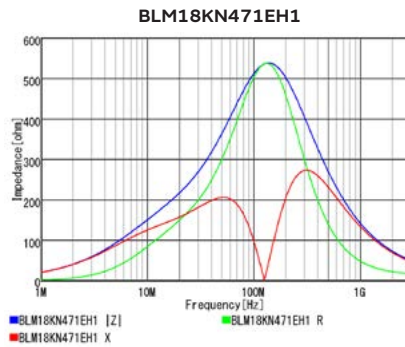
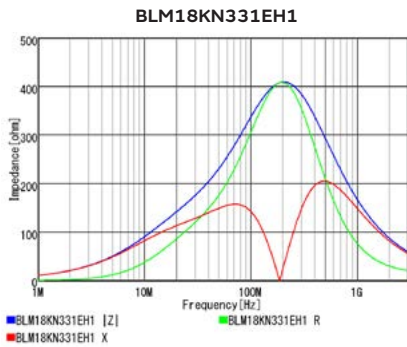
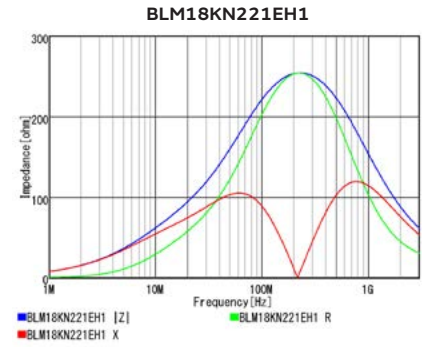
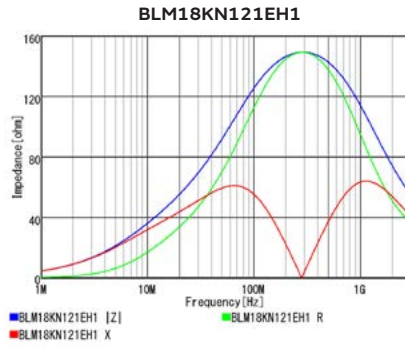
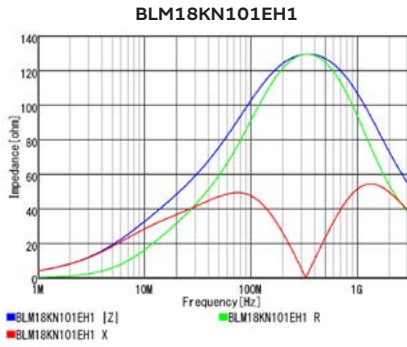

## Derating of Rated Current

In operating temperature exceeding +125°C, derating of current is necessary for this series. Please apply the derating curve shown in chart according to the operating temperature.

### Derating of Rated Current

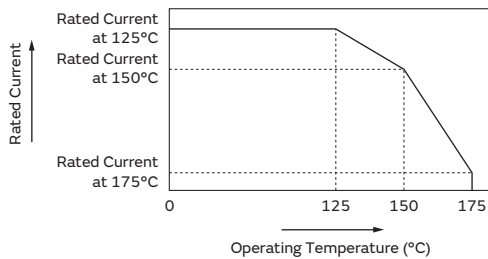

# Chip Ferrite Bead SMD Type

## BLM18AG Series 0603/1608(inch/mm)

### Specifications Sheet (with cautions/mounting/packaging)

Infotainment	<a href="https://www.murata.com/products/productdata/8796200304670/QNFA9122.pdf?1615959120000">https://www.murata.com/products/productdata/8796200304670/QNFA9122.pdf?1615959120000</a>
Powertrain/Safety	<a href="https://www.murata.com/products/productdata/8796199485470/QNFA9101.pdf?1608273989000">https://www.murata.com/products/productdata/8796199485470/QNFA9101.pdf?1608273989000</a>

### Appearance/Dimensions

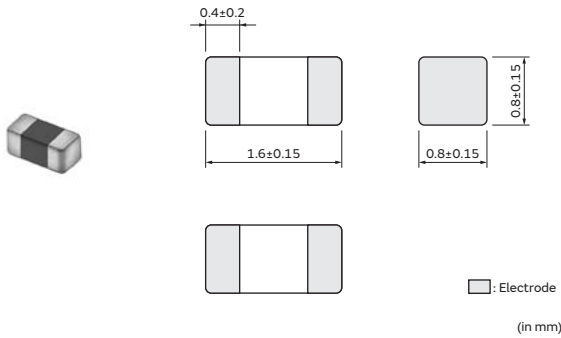

### Packaging

Code	Packaging	Minimum Quantity
D	ø180mm Paper Tape	4000
J	ø330mm Paper Tape	10000
B	Bulk(Bag)	1000

### Equivalent Circuit



(Resistance element becomes dominant at high frequencies.)

### Rated Value (□: packaging code)

Part Number		Impedance at 100MHz	Rated Current at 85°C	Rated Current at 125°C	DC Resistance (Max.)
Infotainment	Powertrain/Safety				
BLM18AG121SZ1□	BLM18AG121SH1□	120Ω±25%	800mA	800mA	0.18Ω
BLM18AG151SZ1□	BLM18AG151SH1□	150Ω±25%	700mA	700mA	0.25Ω
BLM18AG221SZ1□	BLM18AG221SH1□	220Ω±25%	700mA	700mA	0.25Ω
BLM18AG331SZ1□	BLM18AG331SH1□	330Ω±25%	600mA	600mA	0.3Ω
BLM18AG471SZ1□	BLM18AG471SH1□	470Ω±25%	550mA	550mA	0.35Ω
BLM18AG601SZ1□	BLM18AG601SH1□	600Ω±25%	500mA	500mA	0.38Ω
BLM18AG102SZ1□	BLM18AG102SH1□	1000Ω±25%	450mA	450mA	0.5Ω

Operating Temp. Range: -55°C to 125°C

### Z-f characteristics

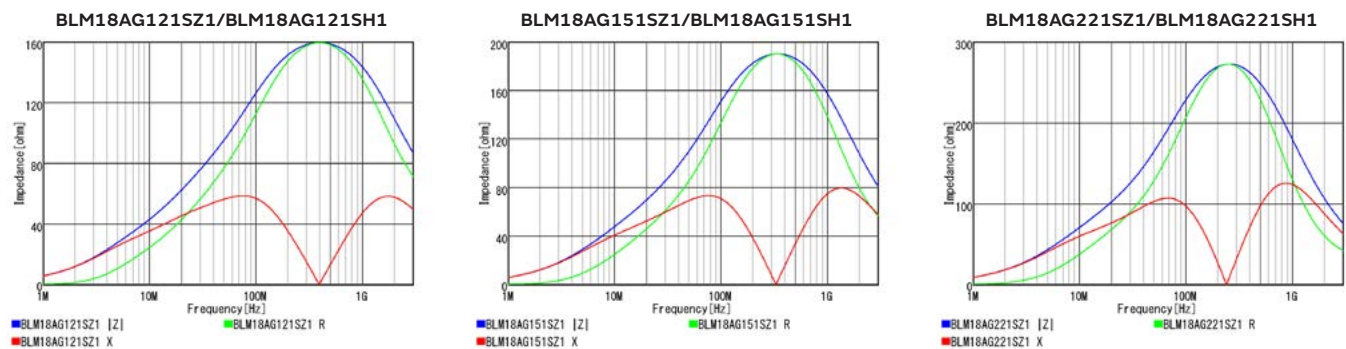

Continued on the following page. ↗



Continued from the preceding page. ↘

## Z-f characteristics

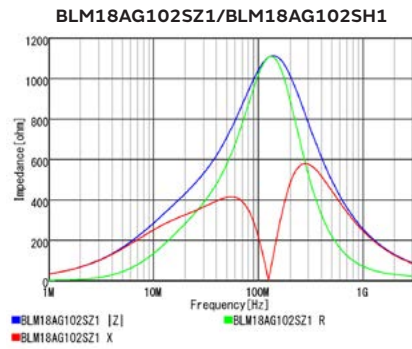
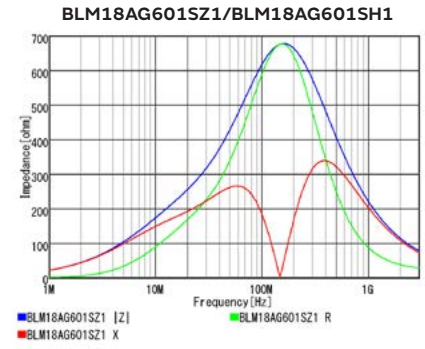
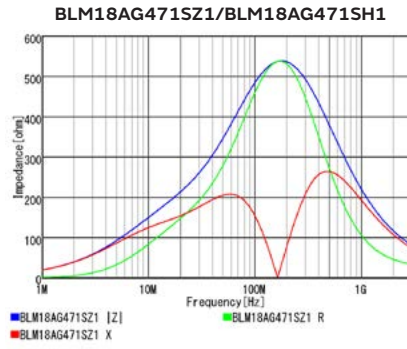
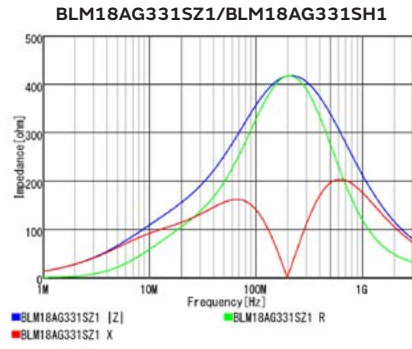

Chip Ferrite Bead

Chip EMI FIL

Chip Common Mode  
 Choke Coil

Block Type EMI FIL

Microchip Transformer  
 (Balun)

Inductors  
 for Power Lines

Inductors for  
 General Circuits

RF Inductors

# Chip Ferrite Bead SMD Type

## BLM18AG(150°C Available) Series 0603/1608(inch/mm)

### Specifications Sheet (with cautions/mounting/packaging)

Infotainment	—
Powertrain/Safety	<a href="https://www.murata.com/products/productdata/8798136533022/QNFA9129.pdf?1535610960000">https://www.murata.com/products/productdata/8798136533022/QNFA9129.pdf?1535610960000</a>

### Appearance/Dimensions

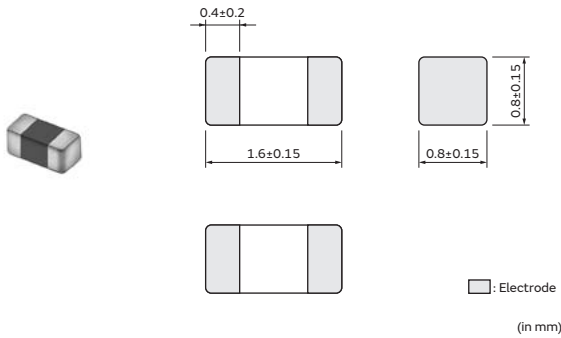

### Packaging

Code	Packaging	Minimum Quantity
D	ø180mm Paper Tape	4000
B	Bulk(Bag)	1000

### Equivalent Circuit



(Resistance element becomes dominant at high frequencies.)

### Rated Value (□: packaging code)

Part Number		Impedance at 100MHz	Rated Current at 85°C	DC Resistance (Max.)
Infotainment	Powertrain/Safety			
—	BLM18AG121BH1□	120Ω±25%	800mA	0.18Ω
—	BLM18AG151BH1□	150Ω±25%	700mA	0.25Ω
—	BLM18AG221BH1□	220Ω±25%	700mA	0.25Ω
—	BLM18AG331BH1□	330Ω±25%	600mA	0.3Ω
—	BLM18AG471BH1□	470Ω±25%	550mA	0.35Ω
—	BLM18AG601BH1□	600Ω±25%	500mA	0.38Ω
—	BLM18AG102BH1□	1000Ω±25%	450mA	0.5Ω

Rated Current at 150°C: 10mA  
 Operating Temp. Range: -55°C to 150°C

### Z-f characteristics

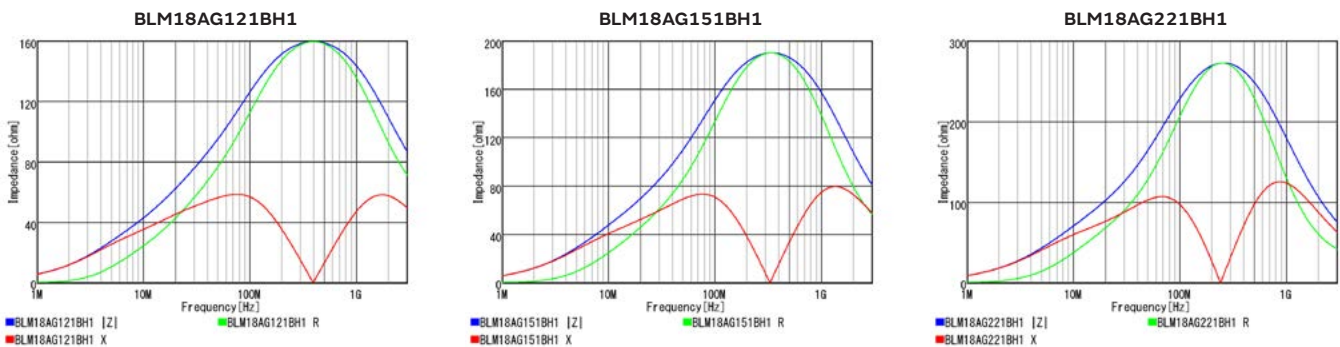

Continued on the following page. ↗



Continued from the preceding page. ↘

## Z-f characteristics

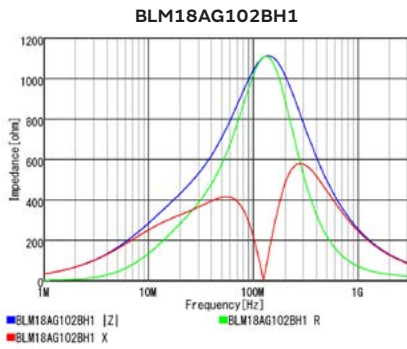
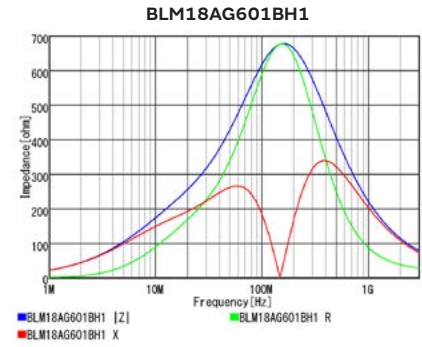
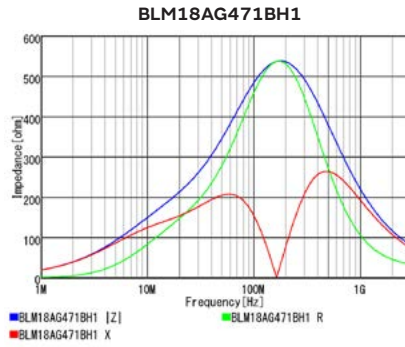
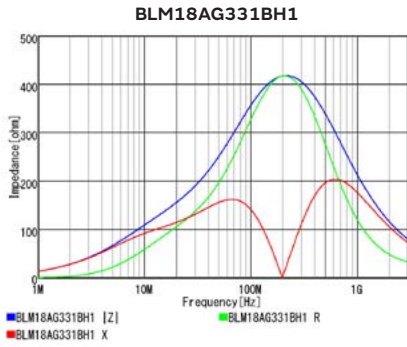

## Derating of Rated Current

In operating temperature exceeding +125°C, derating of current is necessary for BLM18AG\_BH1 series.  
 Please apply the derating curve shown in chart according to the operating temperature.

Derating of Rated Current

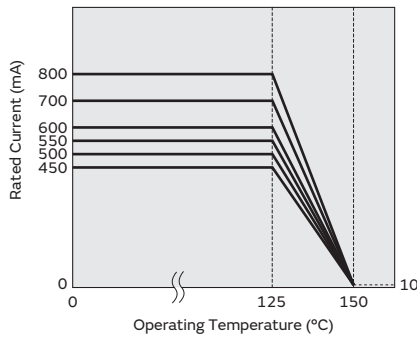

# Chip Ferrite Bead SMD Type

## BLM18AG(for conductive glue mounting) Series 0603/1608(inch/mm)

### Specifications Sheet (with cautions/mounting/packaging)

Infotainment	—
Powertrain/Safety	<a href="https://www.murata.com/products/productdata/8800912113694/QNFA9143.pdf?1615959120000">https://www.murata.com/products/productdata/8800912113694/QNFA9143.pdf?1615959120000</a>

### Appearance/Dimensions

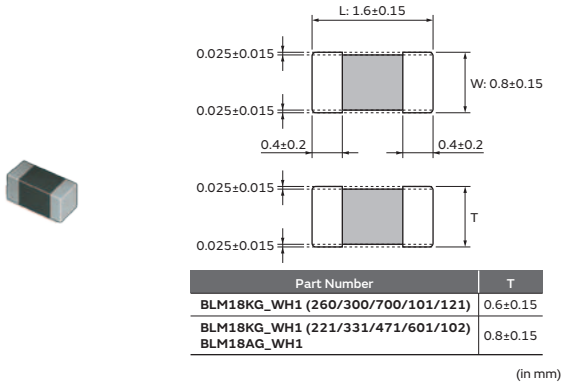

### Packaging

Code	Packaging	Minimum Quantity
D	ø180mm Paper Tape	4000
J	ø330mm Paper Tape	10000
B	Bulk(Bag)	1000

### Equivalent Circuit



(Resistance element becomes dominant at high frequencies.)

### Rated Value (□: packaging code)

Part Number		Impedance at 100MHz	Rated Current at 85°C	Rated Current at 150°C	DC Resistance (Max.)
Infotainment	Powertrain/Safety				
—	<b>BLM18AG471WH1</b>	470Ω±25%	1A	500mA	0.2Ω
—	<b>BLM18AG102WH1</b>	1000Ω±25%	200mA	200mA	0.7Ω

Operating Temp. Range: -55°C to 150°C

### Z-f characteristics

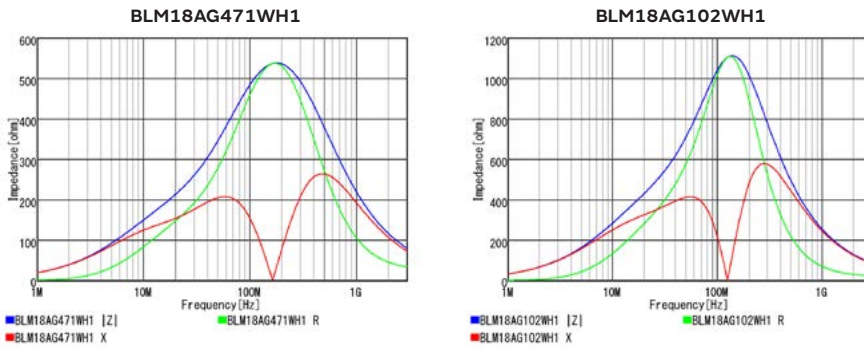

Continued on the following page. ↗

Continued from the preceding page. ↘

## Derating of Rated Current

In operating temperature exceeding +125°C, derating of current is necessary for BLM18AG\_WH1 series.  
Please apply the derating curve shown in chart according to the operating temperature.

Derating of Rated Current

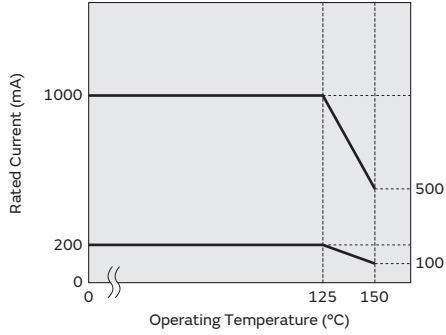

# Chip Ferrite Bead SMD Type

## BLM18BA Series 0603/1608(inch/mm)

### Specifications Sheet (with cautions/mounting/packaging)

Infotainment	<a href="https://www.murata.com/products/productdata/8796200304670/QNFA9122.pdf?1615959120000">https://www.murata.com/products/productdata/8796200304670/QNFA9122.pdf?1615959120000</a>
Powertrain/Safety	<a href="https://www.murata.com/products/productdata/8796199485470/QNFA9101.pdf?1608273989000">https://www.murata.com/products/productdata/8796199485470/QNFA9101.pdf?1608273989000</a>

### Appearance/Dimensions

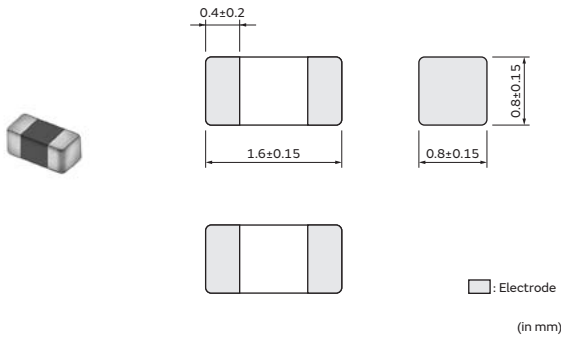

### Packaging

Code	Packaging	Minimum Quantity
D	ø180mm Paper Tape	4000
J	ø330mm Paper Tape	10000
B	Bulk(Bag)	1000

### Equivalent Circuit



(Resistance element becomes dominant at high frequencies.)

### Rated Value (□: packaging code)

Part Number		Impedance at 100MHz	Rated Current at 85°C	Rated Current at 125°C	DC Resistance (Max.)
Infotainment	Powertrain/Safety				
BLM18BA050SZ1□	BLM18BA050SH1□	5Ω±25%	500mA	500mA	0.2Ω
BLM18BA100SZ1□	BLM18BA100SH1□	10Ω±25%	500mA	500mA	0.25Ω
BLM18BA220SZ1□	BLM18BA220SH1□	22Ω±25%	500mA	500mA	0.35Ω
BLM18BA470SZ1□	BLM18BA470SH1□	47Ω±25%	300mA	300mA	0.55Ω
BLM18BA750SZ1□	BLM18BA750SH1□	75Ω±25%	300mA	300mA	0.7Ω
BLM18BA121SZ1□	BLM18BA121SH1□	120Ω±25%	200mA	200mA	0.9Ω

Operating Temp. Range: -55°C to 125°C

### Z-f characteristics

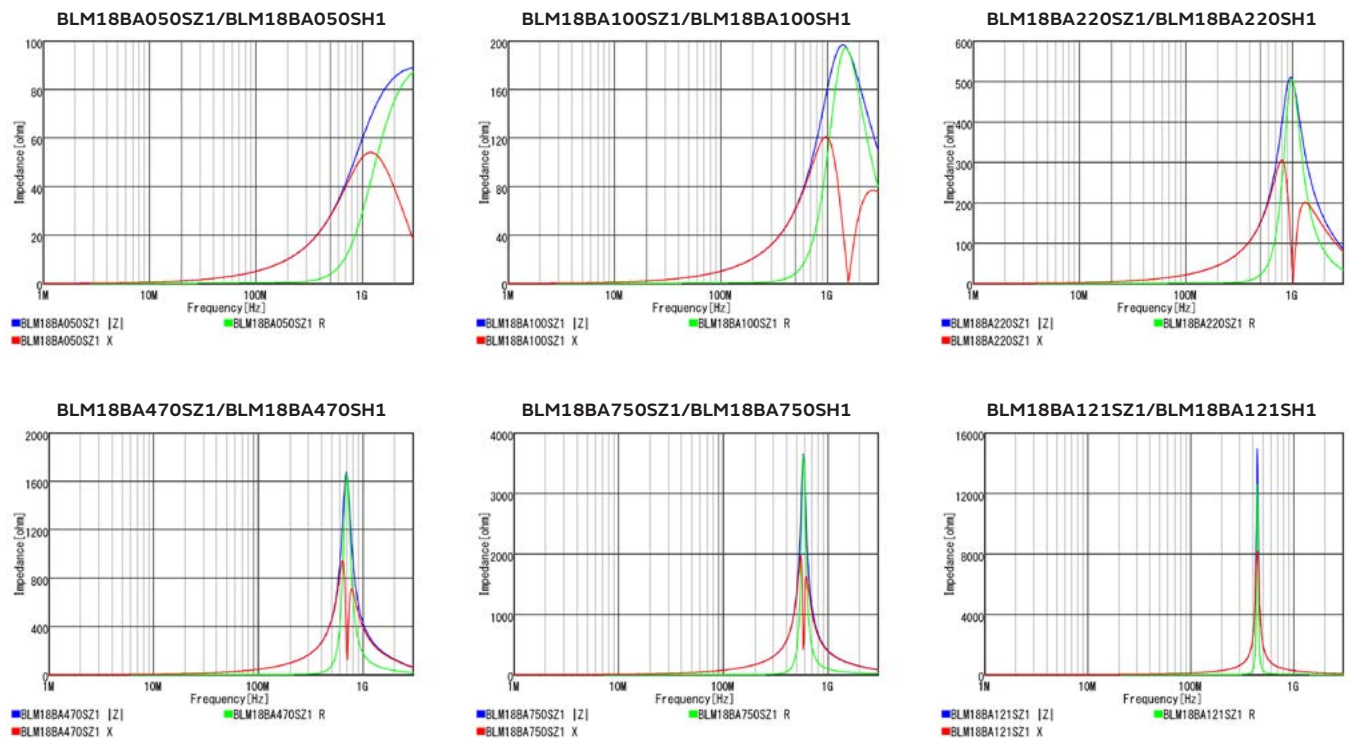

# Chip Ferrite Bead SMD Type

## BLM18BB Series 0603/1608(inch/mm)

### Specifications Sheet (with cautions/mounting/packaging)

Infotainment	<a href="https://www.murata.com/products/productdata/8796200304670/QNFA9122.pdf?1615959120000">https://www.murata.com/products/productdata/8796200304670/QNFA9122.pdf?1615959120000</a>
Powertrain/Safety	<a href="https://www.murata.com/products/productdata/8796199485470/QNFA9101.pdf?1608273989000">https://www.murata.com/products/productdata/8796199485470/QNFA9101.pdf?1608273989000</a>

### Appearance/Dimensions

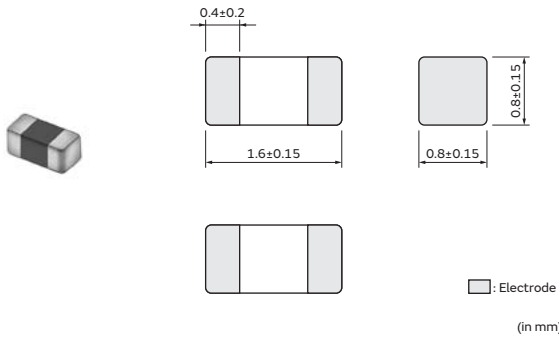

### Packaging

Code	Packaging	Minimum Quantity
D	ø180mm Paper Tape	4000
J	ø330mm Paper Tape	10000
B	Bulk(Bag)	1000

### Equivalent Circuit

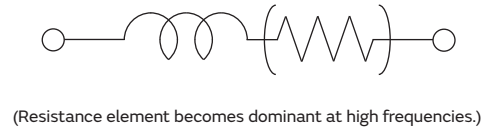

### Rated Value (□: packaging code)

Part Number		Impedance at 100MHz	Rated Current at 85°C	Rated Current at 125°C	DC Resistance (Max.)
Infotainment	Powertrain/Safety				
BLM18BB050SZ1□	BLM18BB050SH1□	5Ω±25%	800mA	800mA	0.05Ω
BLM18BB100SZ1□	BLM18BB100SH1□	10Ω±25%	700mA	700mA	0.1Ω
BLM18BB220SZ1□	BLM18BB220SH1□	22Ω±25%	700mA	700mA	0.2Ω
BLM18BB470SZ1□	BLM18BB470SH1□	47Ω±25%	600mA	600mA	0.25Ω
BLM18BB600SZ1□	BLM18BB600SH1□	60Ω±25%	600mA	600mA	0.25Ω
BLM18BB750SZ1□	BLM18BB750SH1□	75Ω±25%	600mA	600mA	0.3Ω
BLM18BB121SZ1□	BLM18BB121SH1□	120Ω±25%	550mA	550mA	0.3Ω
BLM18BB141SZ1□	BLM18BB141SH1□	140Ω±25%	500mA	500mA	0.35Ω
BLM18BB151SZ1□	BLM18BB151SH1□	150Ω±25%	450mA	450mA	0.37Ω
BLM18BB221SZ1□	BLM18BB221SH1□	220Ω±25%	450mA	450mA	0.45Ω
BLM18BB331SZ1□	BLM18BB331SH1□	330Ω±25%	400mA	400mA	0.58Ω
BLM18BB471SZ1□	BLM18BB471SH1□	470Ω±25%	300mA	300mA	0.85Ω

Operating Temp. Range: -55°C to 125°C

### Z-f characteristics

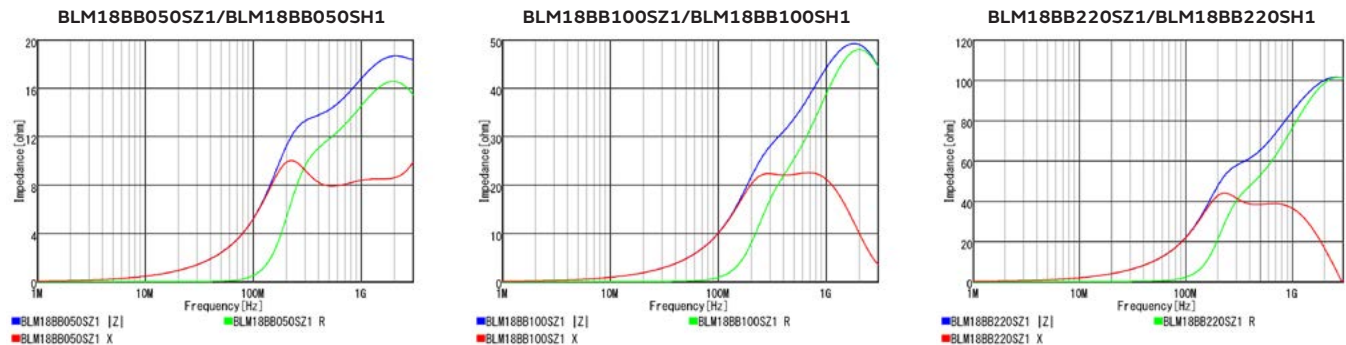

Continued from the preceding page. ↘

## Z-f characteristics

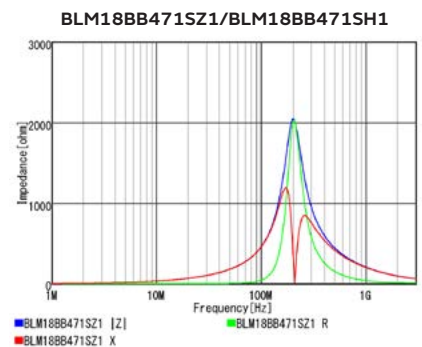
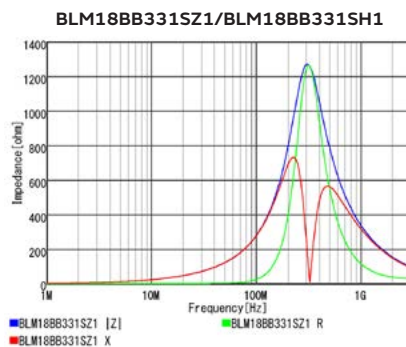
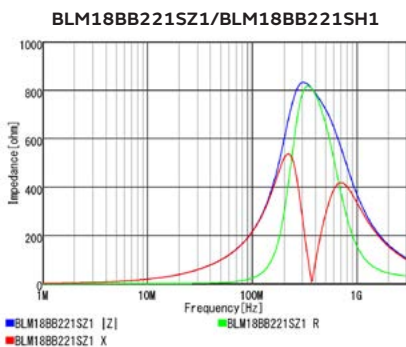
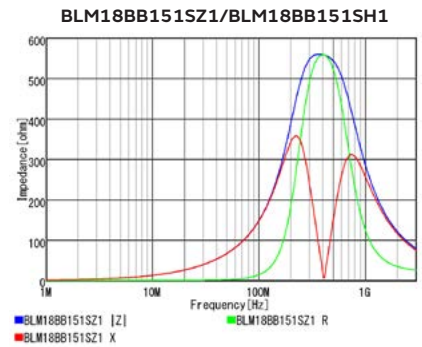
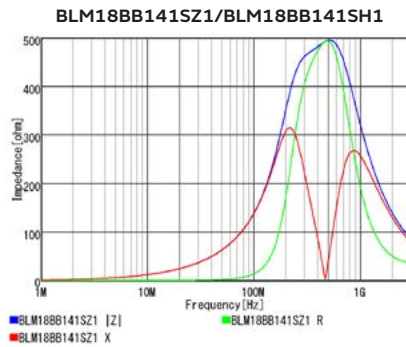
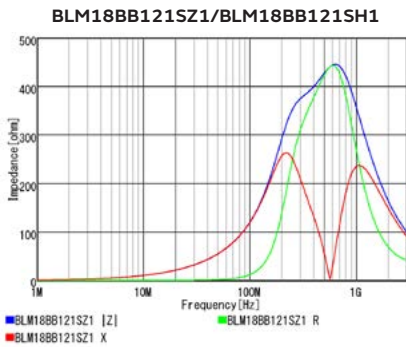
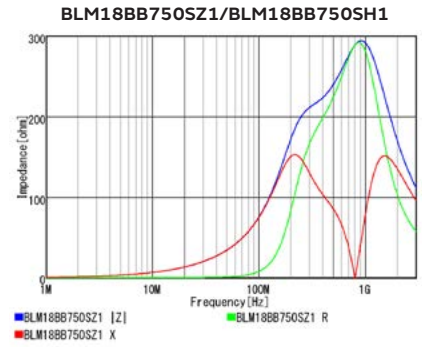
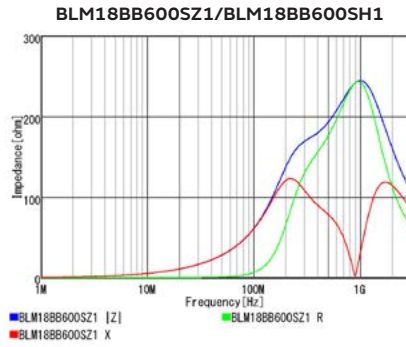
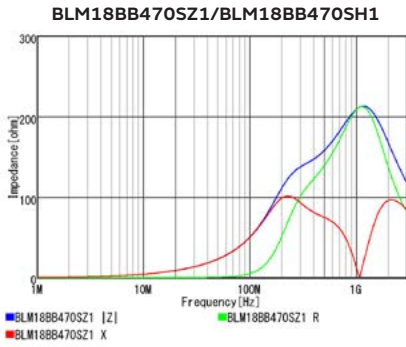

Chip Ferrite Bead  
 Chip EMIFIL  
 Chip Common Mode Choke Coil  
 Block Type EMIFIL  
 Microchip Transformer (Balun)  
 Inductors for Power Lines  
 Inductors for General Circuits  
 RF Inductors

# Chip Ferrite Bead SMD Type

## BLM18BD Series 0603/1608(inch/mm)

### Specifications Sheet (with cautions/mounting/packaging)

Infotainment	<a href="https://www.murata.com/products/productdata/8796200304670/QNFA9122.pdf?1615959120000">https://www.murata.com/products/productdata/8796200304670/QNFA9122.pdf?1615959120000</a>
Powertrain/Safety	<a href="https://www.murata.com/products/productdata/8796199485470/QNFA9101.pdf?1608273989000">https://www.murata.com/products/productdata/8796199485470/QNFA9101.pdf?1608273989000</a>

### Appearance/Dimensions

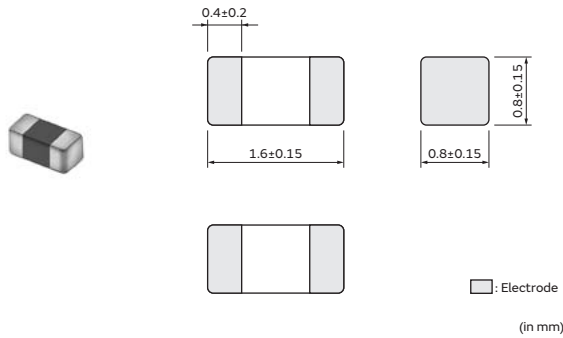

### Packaging

Code	Packaging	Minimum Quantity
D	ø180mm Paper Tape	4000
J	ø330mm Paper Tape	10000
B	Bulk(Bag)	1000

### Equivalent Circuit

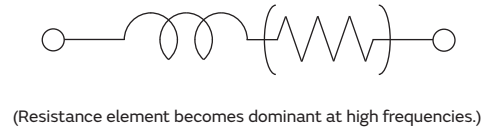

### Rated Value (□: packaging code)

Part Number		Impedance at 100MHz	Rated Current at 85°C	Rated Current at 125°C	DC Resistance (Max.)
Infotainment	Powertrain/Safety				
BLM18BD470SZ1□	BLM18BD470SH1□	47Ω±25%	500mA	500mA	0.3Ω
BLM18BD121SZ1□	BLM18BD121SH1□	120Ω±25%	300mA	300mA	0.4Ω
BLM18BD151SZ1□	BLM18BD151SH1□	150Ω±25%	300mA	300mA	0.4Ω
BLM18BD221SZ1□	BLM18BD221SH1□	220Ω±25%	250mA	250mA	0.45Ω
BLM18BD331SZ1□	BLM18BD331SH1□	330Ω±25%	250mA	250mA	0.5Ω
BLM18BD421SZ1□	BLM18BD421SH1□	420Ω±25%	250mA	250mA	0.55Ω
BLM18BD471SZ1□	BLM18BD471SH1□	470Ω±25%	250mA	250mA	0.55Ω
BLM18BD601SZ1□	BLM18BD601SH1□	600Ω±25%	200mA	200mA	0.65Ω
BLM18BD102SZ1□	BLM18BD102SH1□	1000Ω±25%	200mA	200mA	0.85Ω
BLM18BD152SZ1□	BLM18BD152SH1□	1500Ω±25%	150mA	150mA	1.2Ω
BLM18BD182SZ1□	BLM18BD182SH1□	1800Ω±25%	150mA	150mA	1.5Ω
BLM18BD222SZ1□	BLM18BD222SH1□	2200Ω±25%	150mA	150mA	1.5Ω
BLM18BD252SZ1□	BLM18BD252SH1□	2500Ω±25%	150mA	150mA	1.5Ω

Operating Temp. Range: -55°C to 125°C

### Z-f characteristics

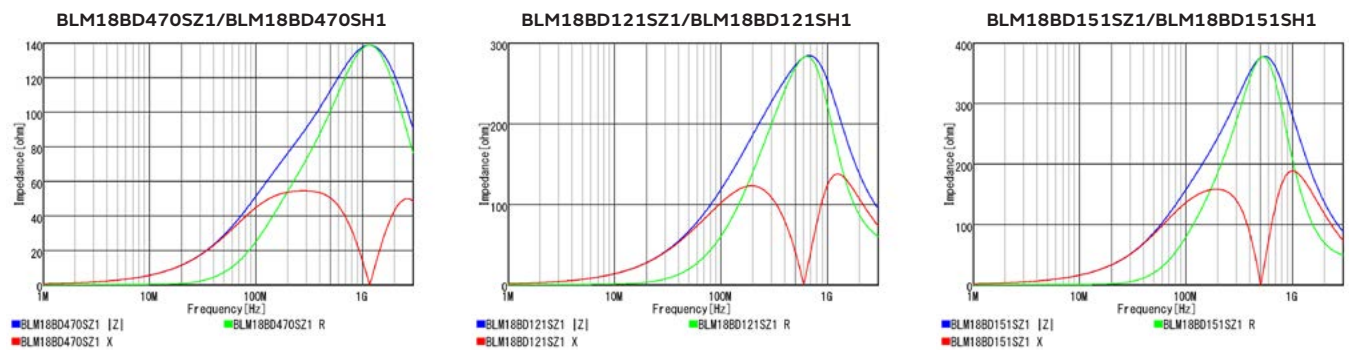

Continued on the following page. ↗



Continued from the preceding page. ↘

## Z-f characteristics

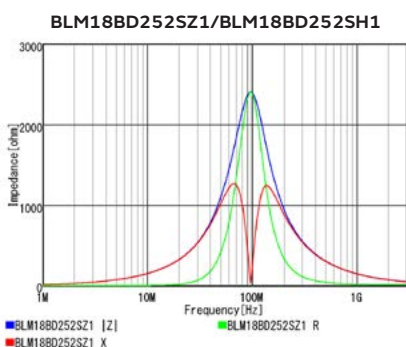
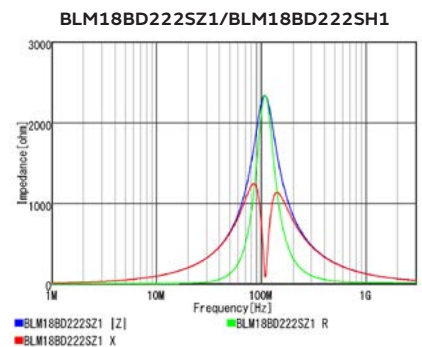
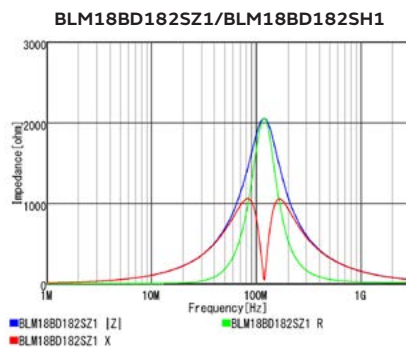
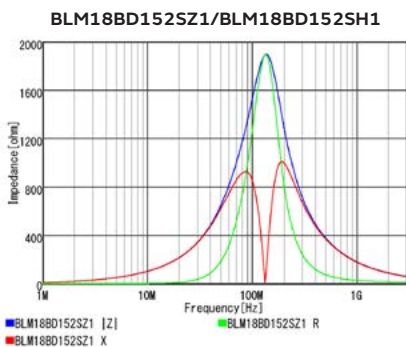
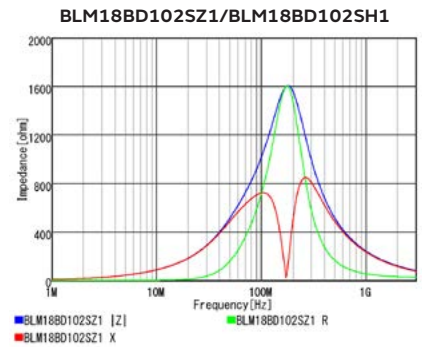
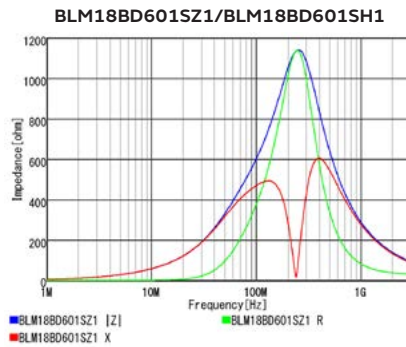
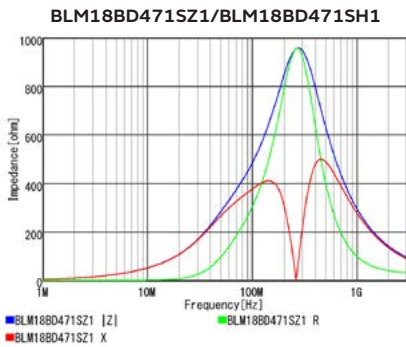
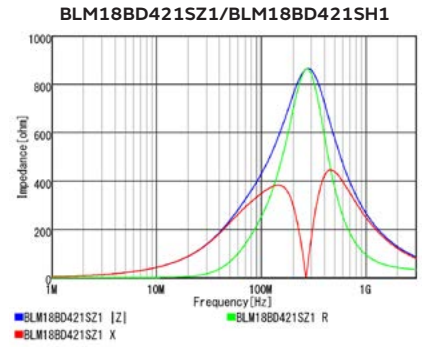
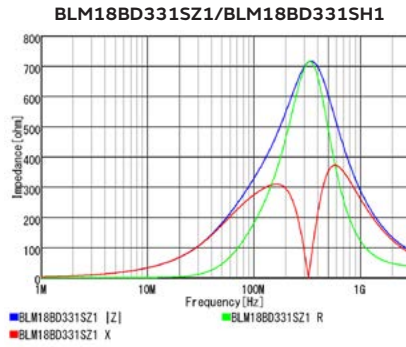
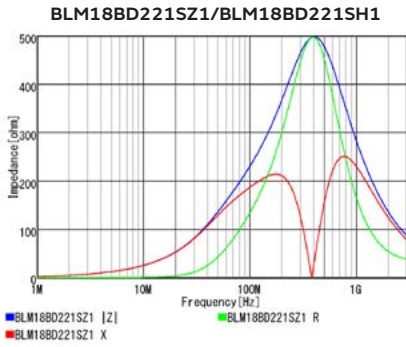

Chip Ferrite Bead

Chip EMIFIL

Chip Common Mode Choke Coil

Block Type EMIFIL

Microchip Transformer (Balun)

Inductors for Power Lines

Inductors for General Circuits

RF Inductors



# Chip Ferrite Bead SMD Type

## BLM18BD(150°C Available) Series 0603/1608(inch/mm)

### Specifications Sheet (with cautions/mounting/packaging)

Infotainment	—
Powertrain/Safety	<a href="https://www.murata.com/products/productdata/8798136533022/QNFA9129.pdf?1535610960000">https://www.murata.com/products/productdata/8798136533022/QNFA9129.pdf?1535610960000</a>

### Appearance/Dimensions

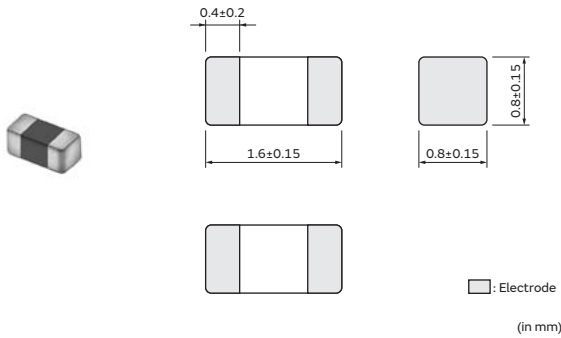

### Packaging

Code	Packaging	Minimum Quantity
D	ø180mm Paper Tape	4000
B	Bulk(Bag)	1000

### Equivalent Circuit

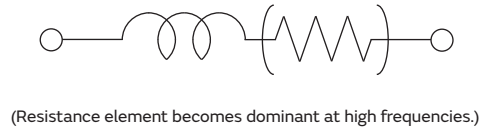

### Rated Value (□: packaging code)

Part Number		Impedance at 100MHz	Rated Current at 85°C	DC Resistance (Max.)
Infotainment	Powertrain/Safety			
—	BLM18BD470BH1□	47Ω±25%	500mA	0.3Ω
—	BLM18BD121BH1□	120Ω±25%	300mA	0.4Ω
—	BLM18BD151BH1□	150Ω±25%	300mA	0.4Ω
—	BLM18BD221BH1□	220Ω±25%	250mA	0.45Ω
—	BLM18BD331BH1□	330Ω±25%	250mA	0.5Ω
—	BLM18BD421BH1□	420Ω±25%	250mA	0.55Ω
—	BLM18BD471BH1□	470Ω±25%	250mA	0.55Ω
—	BLM18BD601BH1□	600Ω±25%	200mA	0.65Ω
—	BLM18BD102BH1□	1000Ω±25%	200mA	0.85Ω
—	BLM18BD152BH1□	1500Ω±25%	150mA	1.2Ω
—	BLM18BD182BH1□	1800Ω±25%	150mA	1.5Ω
—	BLM18BD222BH1□	2200Ω±25%	150mA	1.5Ω
—	BLM18BD252BH1□	2500Ω±25%	150mA	1.5Ω

Rated Current at 150°C: 10mA  
 Operating Temp. Range: -55°C to 150°C

### Z-f characteristics

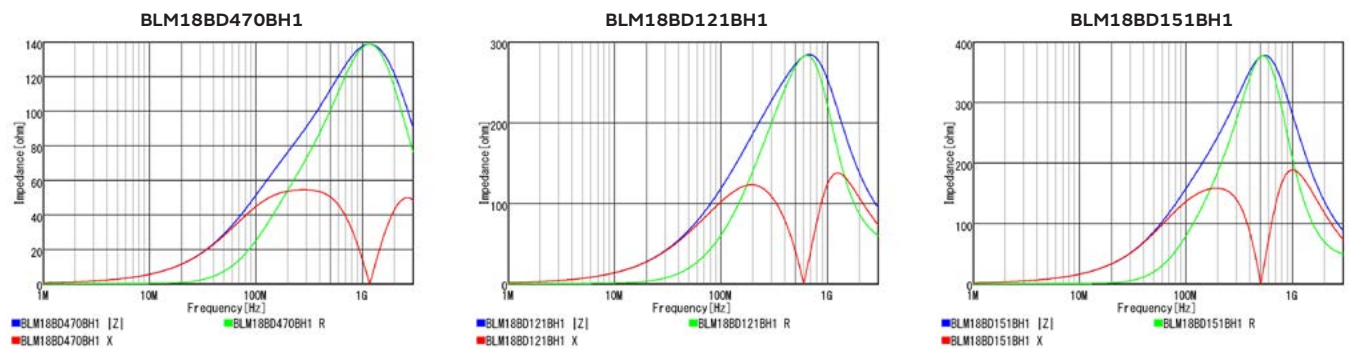

Continued on the following page. ↗

Continued from the preceding page. ↘

## Z-f characteristics

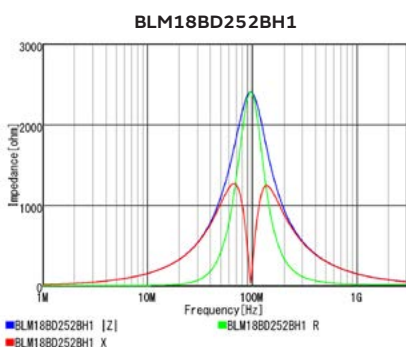
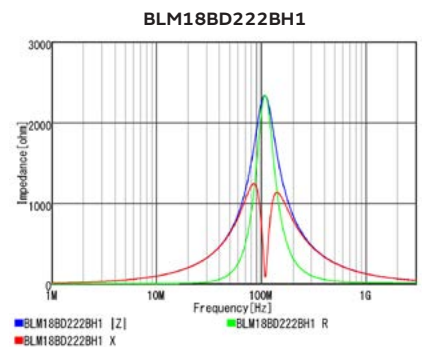
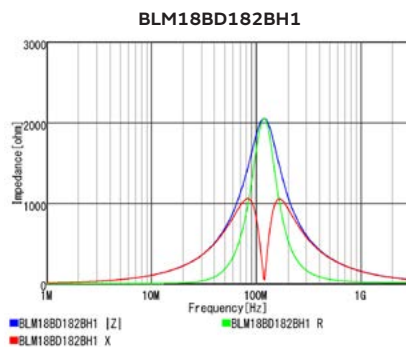
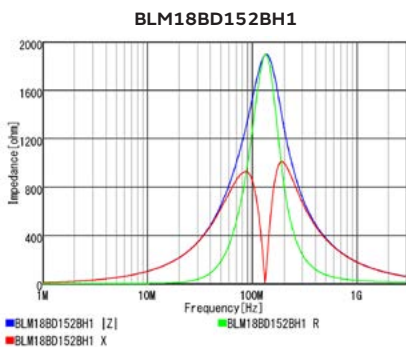
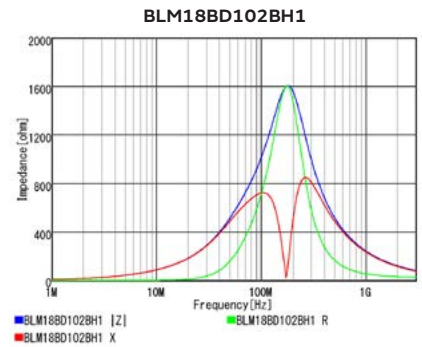
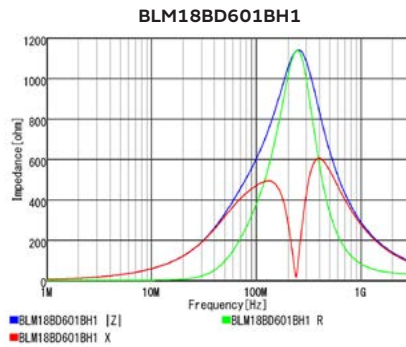
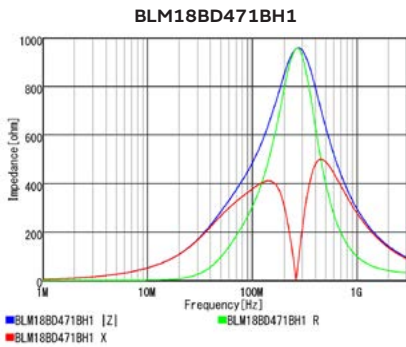
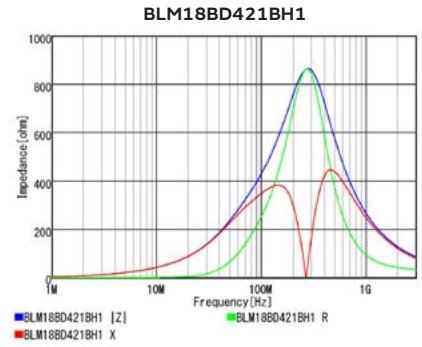
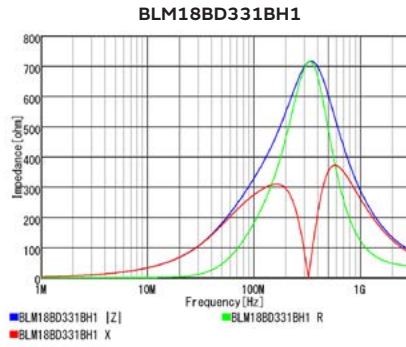
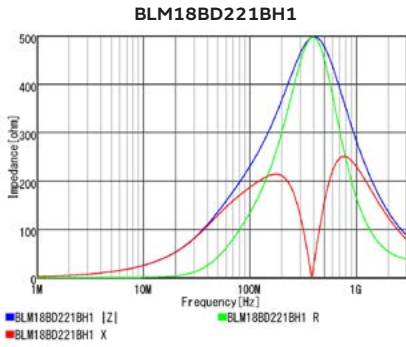

Continued on the following page. ↗

Chip Ferrite Bead  
 Chip EMIFIL  
 Chip Common Mode Choke Coil  
 Block Type EMIFIL  
 Microchip Transformer (Balun)  
 Inductors for Power Lines  
 Inductors for General Circuits  
 RF Inductors

Continued from the preceding page. ↘

## Derating of Rated Current

In operating temperature exceeding +125°C, derating of current is necessary for BLM18BD\_BH1 series.  
Please apply the derating curve shown in chart according to the operating temperature.

Derating of Rated Current

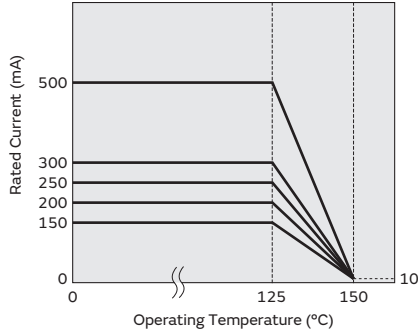

# Chip Ferrite Bead SMD Type

## BLM18DN Series 0603/1608(inch/mm)

### Specifications Sheet (with cautions/mounting/packaging)

Infotainment	<a href="https://www.murata.com/products/productdata/8802892677150/QNFA9158.pdf?1548394596000">https://www.murata.com/products/productdata/8802892677150/QNFA9158.pdf?1548394596000</a>
Powertrain/Safety	<a href="https://www.murata.com/products/productdata/8802892611614/QNFA9159.pdf?1548394596000">https://www.murata.com/products/productdata/8802892611614/QNFA9159.pdf?1548394596000</a>

### Appearance/Dimensions

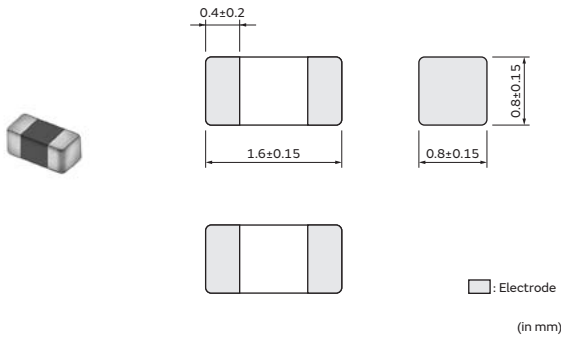

### Packaging

Code	Packaging	Minimum Quantity
D	ø180mm Paper Tape	4000
J	ø330mm Paper Tape	10000
B	Bulk(Bag)	1000

### Equivalent Circuit



(Resistance element becomes dominant at high frequencies.)

### Rated Value (□: packaging code)

Part Number		Impedance at 100MHz	Impedance at 1GHz	Rated Current at 85°C	Rated Current at 125°C	DC Resistance (Max.)
Infotainment	Powertrain/Safety					
BLM18DN151SZ1□	BLM18DN151SH1□	150Ω±25%	400Ω±30%	1.4A	900mA	0.12Ω
BLM18DN221SZ1□	BLM18DN221SH1□	220Ω±25%	650Ω±30%	1A	650mA	0.21Ω
BLM18DN381SZ1□	BLM18DN381SH1□	380Ω±25%	1100Ω±30%	850mA	550mA	0.325Ω
BLM18DN601SZ1□	BLM18DN601SH1□	600Ω±25%	1500Ω±30%	700mA	450mA	0.435Ω

Operating Temp. Range: -55°C to 125°C

### Z-f characteristics

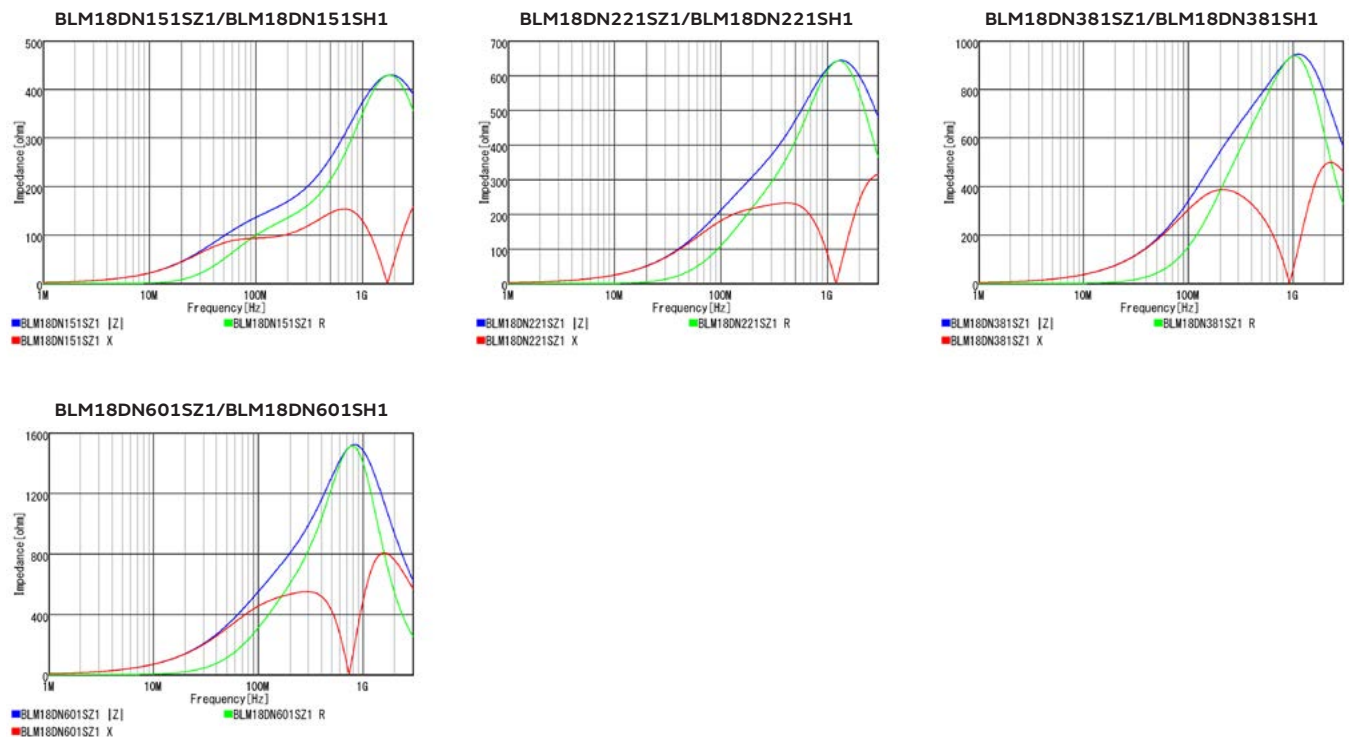

Continued on the following page. ↗

Continued from the preceding page. ↘

## Derating of Rated Current

In operating temperature exceeding +85°C, derating of current is necessary for this series.  
Please apply the derating curve shown in chart according to the operating temperature.

Derating of Rated Current

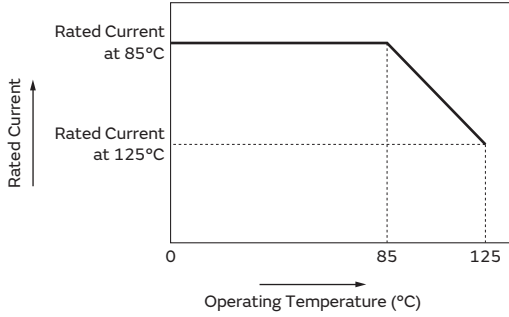

# Chip Ferrite Bead SMD Type

## BLM18HB Series 0603/1608(inch/mm)

### Specifications Sheet (with cautions/mounting/packaging)

Infotainment	<a href="https://www.murata.com/products/productdata/8796200337438/QNFA9123.pdf?1531118256000">https://www.murata.com/products/productdata/8796200337438/QNFA9123.pdf?1531118256000</a>
Powertrain/Safety	—

### Appearance/Dimensions

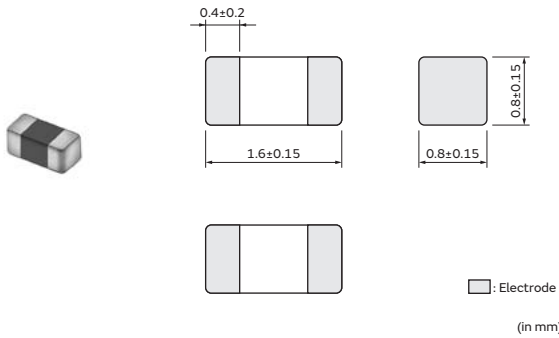

### Packaging

Code	Packaging	Minimum Quantity
D	ø180mm Paper Tape	4000
J	ø330mm Paper Tape	10000
B	Bulk(Bag)	1000

### Equivalent Circuit



(Resistance element becomes dominant at high frequencies.)

### Rated Value (□: packaging code)

Part Number		Impedance at 100MHz	Impedance at 1GHz	Rated Current at 85°C	Rated Current at 125°C	DC Resistance (Max.)
Infotainment	Powertrain/Safety					
BLM18HB121SZ1□	—	120Ω±25%	500Ω±40%	200mA	200mA	0.5Ω
BLM18HB221SZ1□	—	220Ω±25%	1100Ω±40%	100mA	100mA	0.8Ω
BLM18HB331SZ1□	—	330Ω±25%	1600Ω±40%	50mA	50mA	1.2Ω

Operating Temp. Range: -55°C to 125°C

### Z-f characteristics

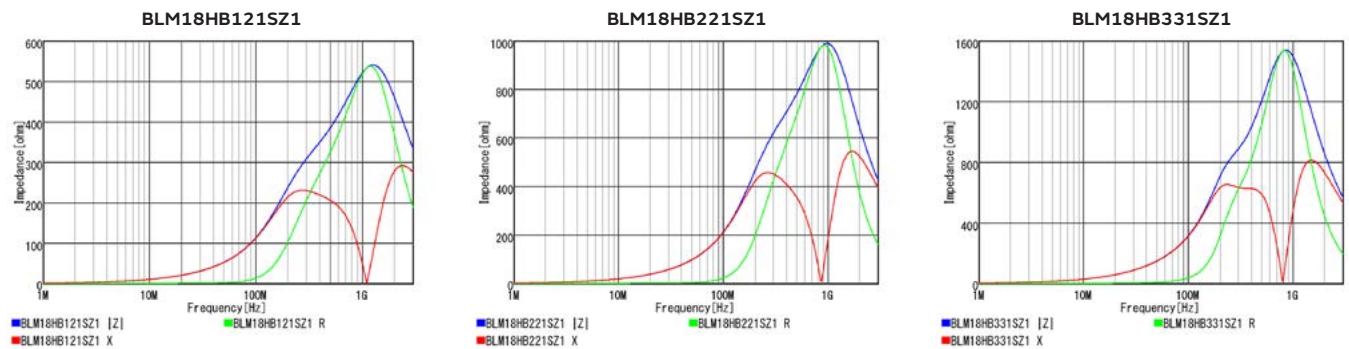

# Chip Ferrite Bead SMD Type

## BLM18HD Series 0603/1608(inch/mm)

### Specifications Sheet (with cautions/mounting/packaging)

Infotainment	<a href="https://www.murata.com/products/productdata/8796200337438/QNFA9123.pdf?1531118256000">https://www.murata.com/products/productdata/8796200337438/QNFA9123.pdf?1531118256000</a>
Powertrain/Safety	<a href="https://www.murata.com/products/productdata/8796199452702/QNFA9104.pdf?1615959120000">https://www.murata.com/products/productdata/8796199452702/QNFA9104.pdf?1615959120000</a>

### Appearance/Dimensions

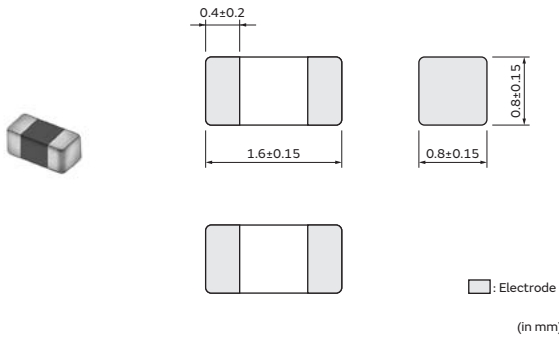

### Packaging

Code	Packaging	Minimum Quantity
D	ø180mm Paper Tape	4000
J	ø330mm Paper Tape	10000
B	Bulk(Bag)	1000

### Equivalent Circuit

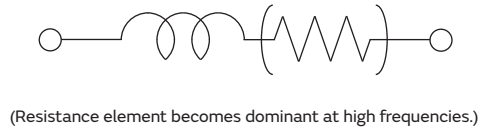

### Rated Value (□: packaging code)

Part Number		Impedance at 100MHz	Impedance at 1GHz	Rated Current at 85°C	Rated Current at 125°C	DC Resistance (Max.)
Infotainment	Powertrain/Safety					
BLM18HD471SZ1□	BLM18HD471SH1□	470Ω±25%	1000Ω(Typ.)	100mA	100mA	1.2Ω
BLM18HD601SZ1□	BLM18HD601SH1□	600Ω±25%	1200Ω(Typ.)	100mA	100mA	1.5Ω
BLM18HD102SZ1□	BLM18HD102SH1□	1000Ω±25%	1700Ω(Typ.)	50mA	50mA	1.8Ω

Operating Temp. Range: -55°C to 125°C

### Z-f characteristics

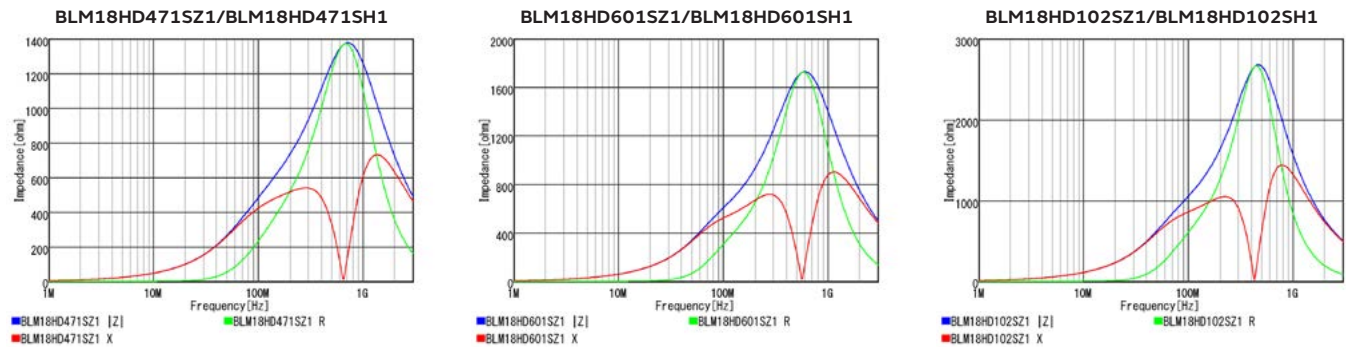



# Chip Ferrite Bead SMD Type

## BLM18HE Series 0603/1608(inch/mm)

### Specifications Sheet (with cautions/mounting/packaging)

Infotainment	<a href="https://www.murata.com/products/productdata/8796200337438/QNFA9123.pdf?1531118256000">https://www.murata.com/products/productdata/8796200337438/QNFA9123.pdf?1531118256000</a>
Powertrain/Safety	<a href="https://www.murata.com/products/productdata/8796199452702/QNFA9104.pdf?1615959120000">https://www.murata.com/products/productdata/8796199452702/QNFA9104.pdf?1615959120000</a>

### Appearance/Dimensions

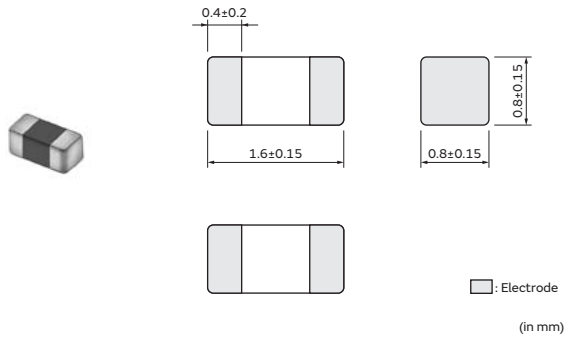

### Packaging

Code	Packaging	Minimum Quantity
D	ø180mm Paper Tape	4000
J	ø330mm Paper Tape	10000
B	Bulk(Bag)	1000

### Equivalent Circuit



(Resistance element becomes dominant at high frequencies.)

### Rated Value (: packaging code)

Part Number		Impedance at 100MHz	Impedance at 1GHz	Rated Current at 85°C	Rated Current at 125°C	DC Resistance (Max.)
Infotainment	Powertrain/Safety					
<a href="#">BLM18HE601SZ1</a> □	<a href="#">BLM18HE601SH1</a> □	600Ω±25%	600Ω(Typ.)	800mA	600mA	0.25Ω
<a href="#">BLM18HE102SZ1</a> □	<a href="#">BLM18HE102SH1</a> □	1000Ω±25%	1000Ω(Typ.)	600mA	500mA	0.35Ω
<a href="#">BLM18HE152SZ1</a> □	<a href="#">BLM18HE152SH1</a> □	1500Ω±25%	1500Ω(Typ.)	500mA	400mA	0.5Ω

Operating Temp. Range: -55°C to 125°C

### Z-f characteristics

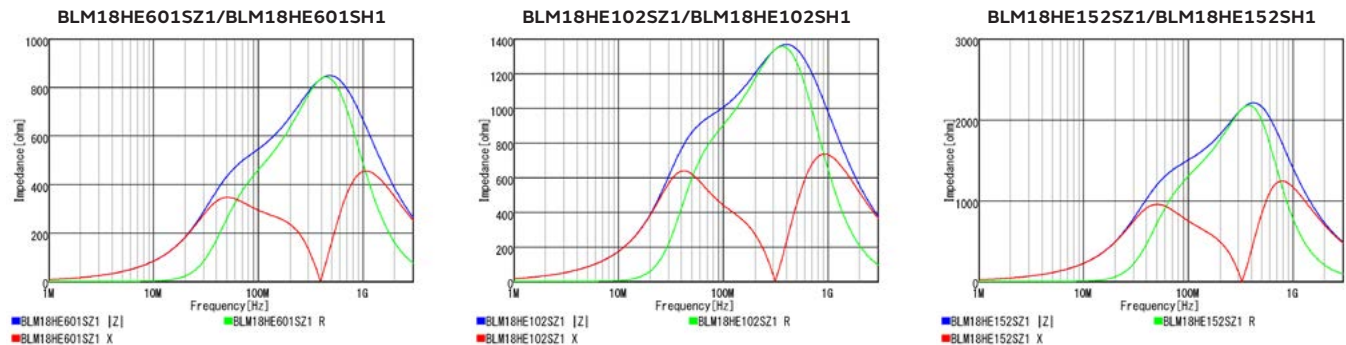

Continued on the following page. ↗

Continued from the preceding page. ↘

## Derating of Rated Current

In operating temperature exceeding +85°C, derating of current is necessary for BLM18HE series.  
Please apply the derating curve shown in chart according to the operating temperature.

Derating of Rated Current

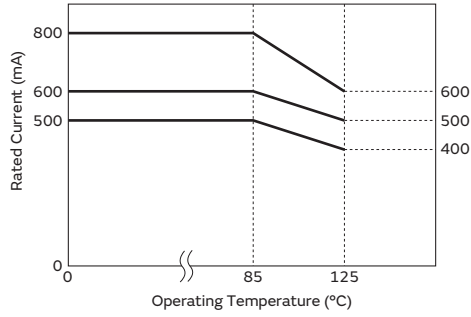

# Chip Ferrite Bead SMD Type

## BLM18HG Series 0603/1608(inch/mm)

### Specifications Sheet (with cautions/mounting/packaging)

Infotainment	<a href="https://www.murata.com/products/productdata/8796200337438/QNFA9123.pdf?1531118256000">https://www.murata.com/products/productdata/8796200337438/QNFA9123.pdf?1531118256000</a>
Powertrain/Safety	<a href="https://www.murata.com/products/productdata/8796199452702/QNFA9104.pdf?1615959120000">https://www.murata.com/products/productdata/8796199452702/QNFA9104.pdf?1615959120000</a>

### Appearance/Dimensions

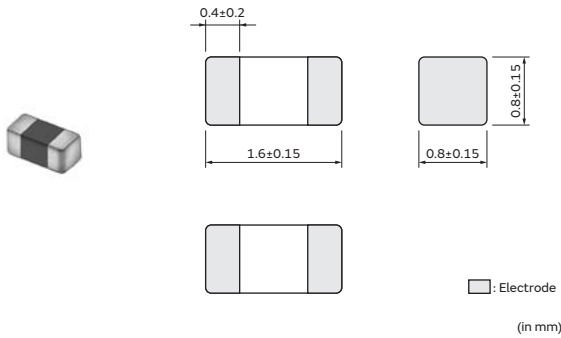

### Packaging

Code	Packaging	Minimum Quantity
D	ø180mm Paper Tape	4000
J	ø330mm Paper Tape	10000
B	Bulk(Bag)	1000

### Equivalent Circuit



(Resistance element becomes dominant at high frequencies.)

### Rated Value (□: packaging code)

Part Number		Impedance at 100MHz	Impedance at 1GHz	Rated Current at 85°C	Rated Current at 125°C	DC Resistance (Max.)
Infotainment	Powertrain/Safety					
BLM18HG471SZ1□	BLM18HG471SH1□	470Ω±25%	600Ω(Typ.)	200mA	200mA	0.85Ω
BLM18HG601SZ1□	BLM18HG601SH1□	600Ω±25%	700Ω(Typ.)	200mA	200mA	1Ω
BLM18HG102SZ1□	BLM18HG102SH1□	1000Ω±25%	1000Ω(Typ.)	100mA	100mA	1.6Ω

Operating Temp. Range: -55°C to 125°C

### Z-f characteristics

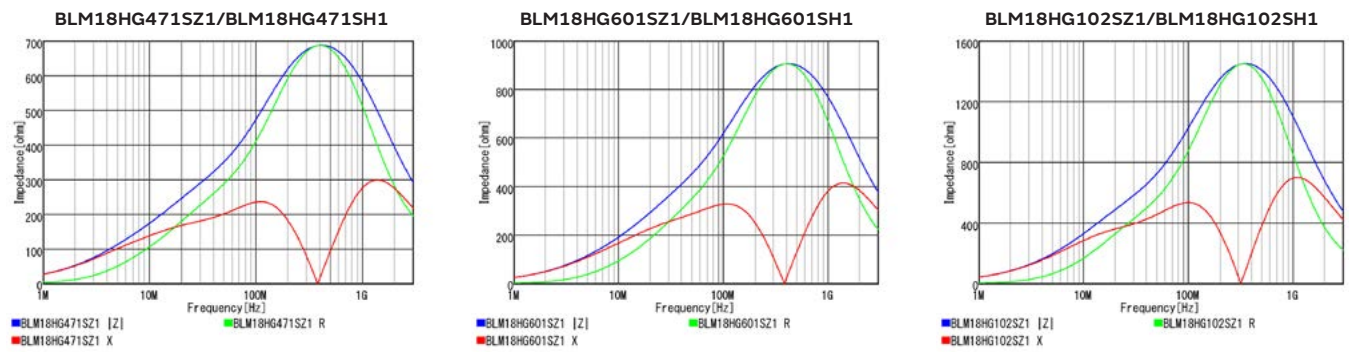

# Chip Ferrite Bead SMD Type

## BLM18EG Series 0603/1608(inch/mm)

### Specifications Sheet (with cautions/mounting/packaging)

Infotainment	<a href="https://www.murata.com/products/productdata/8796200370206/QNFA9124.pdf?1531118256000">https://www.murata.com/products/productdata/8796200370206/QNFA9124.pdf?1531118256000</a>
Powertrain/Safety	<a href="https://www.murata.com/products/productdata/8796199419934/QNFA9107.pdf?1529456408000">https://www.murata.com/products/productdata/8796199419934/QNFA9107.pdf?1529456408000</a>

### Appearance/Dimensions

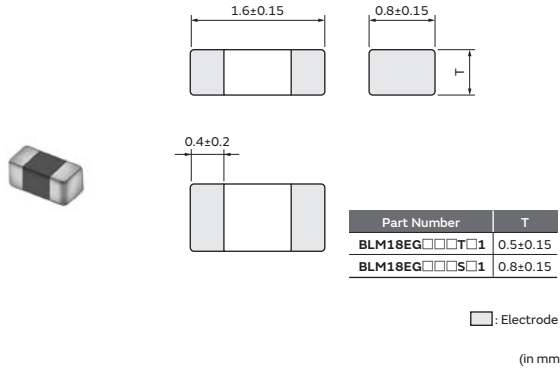

### Packaging

Code	Packaging	Minimum Quantity
D	ø180mm Paper Tape	4000
J	ø330mm Paper Tape	10000
B	Bulk(Bag)	1000

### Equivalent Circuit

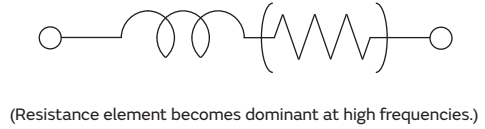

### Rated Value (□: packaging code)

Part Number		Impedance at 100MHz	Impedance at 1GHz	Rated Current at 85°C	Rated Current at 125°C	DC Resistance (Max.)
Infotainment	Powertrain/Safety					
BLM18EG101TZ1□	BLM18EG101TH1□	100Ω±25%	140Ω(Typ.)	2A	1A	0.045Ω
BLM18EG121SZ1□	BLM18EG121SH1□	120Ω±25%	145Ω(Typ.)	2A	1A	0.04Ω
—	BLM18EG181SH1□	180Ω±25%	240Ω(Typ.)	2A	1A	0.05Ω
BLM18EG221SZ1□	—	220Ω±25%	260Ω(Typ.)	2A	1A	0.05Ω
BLM18EG221TZ1□	BLM18EG221TH1□	220Ω±25%	300Ω(Typ.)	1A	1A	0.15Ω
BLM18EG331TZ1□	BLM18EG331TH1□	330Ω±25%	450Ω(Typ.)	500mA	500mA	0.21Ω
BLM18EG391TZ1□	BLM18EG391TH1□	390Ω±25%	520Ω(Typ.)	500mA	500mA	0.3Ω
BLM18EG471SZ1□	BLM18EG471SH1□	470Ω±25%	550Ω(Typ.)	500mA	500mA	0.21Ω
BLM18EG601SZ1□	BLM18EG601SH1□	600Ω±25%	700Ω(Typ.)	500mA	500mA	0.35Ω

Operating Temp. Range: -55°C to 125°C

### Z-f characteristics

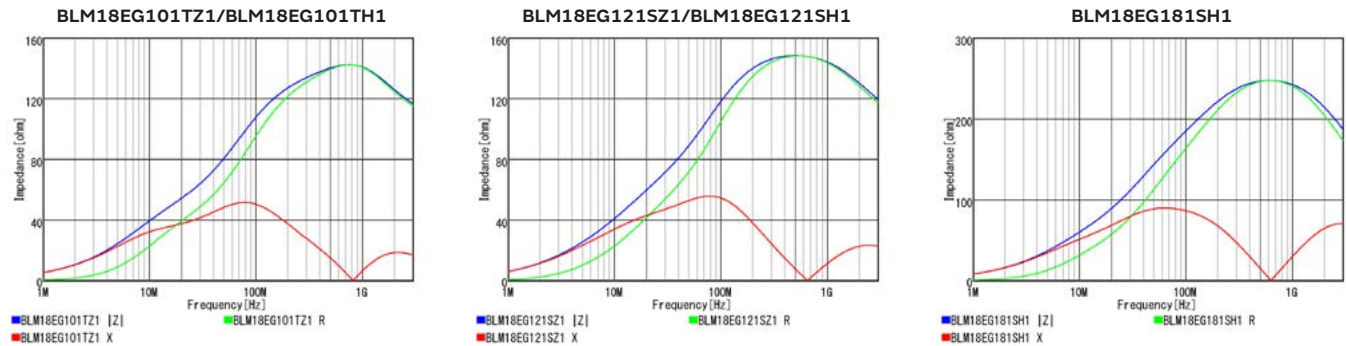

Continued on the following page. ↗

Continued from the preceding page. ↘

## Z-f characteristics

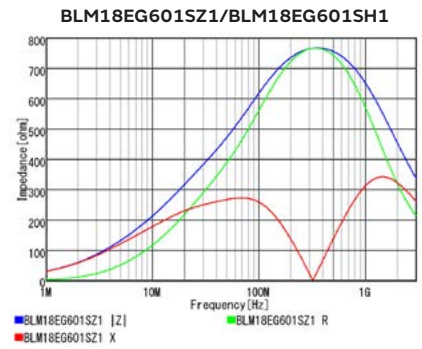
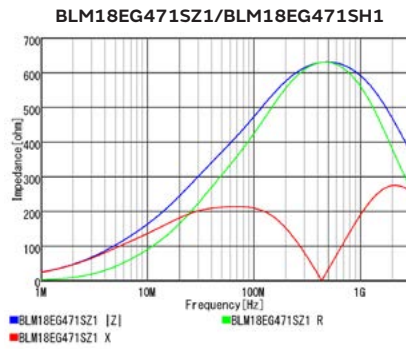
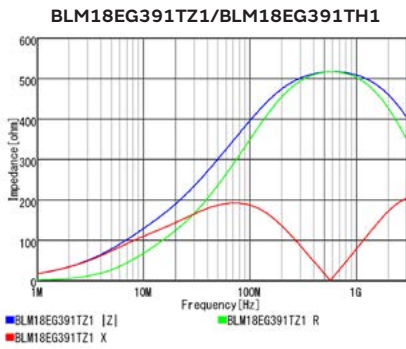
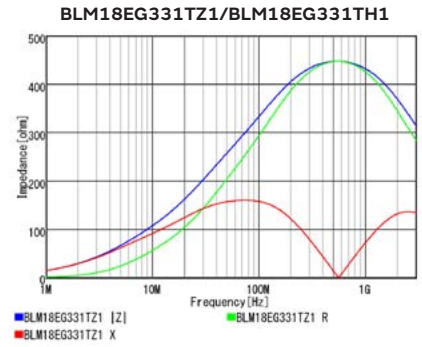
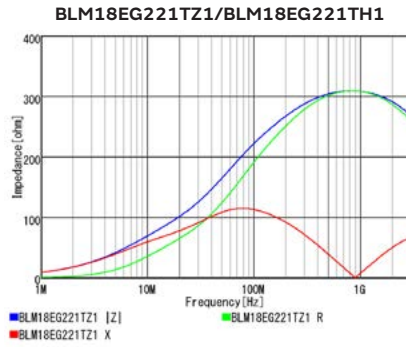
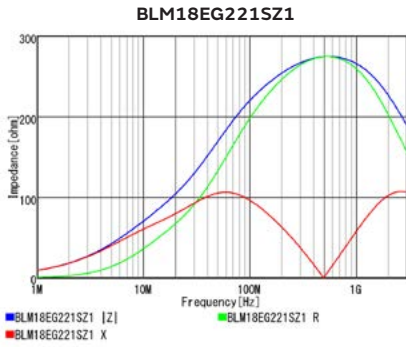

## Derating of Rated Current

In operating temperature exceeding +85°C, derating of current is necessary for BLM18EG series. Please apply the derating curve shown in chart according to the operating temperature.

Derating of Rated Current

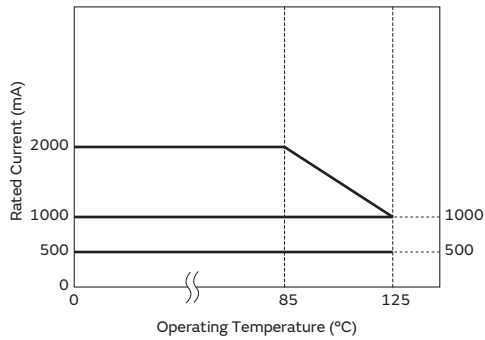

Chip Ferrite Bead

Chip EMIFIL

Chip Common Mode Choke Coil

Block Type EMIFIL

Microchip Transformer (Balun)

Inductors for Power Lines

Inductors for General Circuits

RF Inductors

# Chip Ferrite Bead SMD Type

## BLM18GG Series 0603/1608(inch/mm)

### Specifications Sheet (with cautions/mounting/packaging)

Infotainment	<a href="https://www.murata.com/products/productdata/8796200402974/QNFA9125.pdf?1539737629000">https://www.murata.com/products/productdata/8796200402974/QNFA9125.pdf?1539737629000</a>
Powertrain/Safety	—

### Appearance/Dimensions

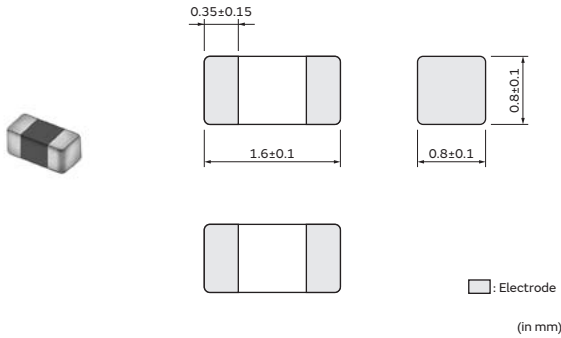

### Packaging

Code	Packaging	Minimum Quantity
D	∅180mm Paper Tape	4000
J	∅330mm Paper Tape	10000
B	Bulk(Bag)	1000

### Equivalent Circuit



(Resistance element becomes dominant at high frequencies.)

### Rated Value (□: packaging code)

Part Number		Impedance at 100MHz	Impedance at 1GHz	Rated Current at 85°C	Rated Current at 125°C	DC Resistance (Max.)	Operating Temp. Range
Infotainment	Powertrain/Safety						
BLM18GG471SZ1□	—	470Ω±25%	1800Ω±30%	200mA	200mA	1.3Ω	-55°C to 125°C

### Z-f characteristics

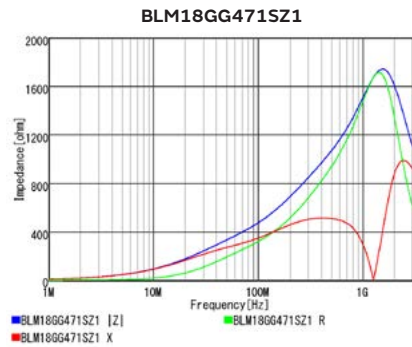

Chip Ferrite Bead  
 Chip EMIFIL  
 Chip Common Mode Choke Coil  
 Block Type EMIFIL  
 Microchip Transformer (Ballun)  
 Inductors for Power Lines  
 Inductors for General Circuits  
 RF Inductors

# Chip Ferrite Bead SMD Type

## BLM21PG Series 0805/2012(inch/mm)

### Specifications Sheet (with cautions/mounting/packaging)

Infotainment	<a href="https://www.murata.com/products/productdata/8796199551006/QNFA9114.pdf?1608273989000">https://www.murata.com/products/productdata/8796199551006/QNFA9114.pdf?1608273989000</a>
Powertrain/Safety	<a href="https://www.murata.com/products/productdata/8796199518238/QNFA9102.pdf?1608273989000">https://www.murata.com/products/productdata/8796199518238/QNFA9102.pdf?1608273989000</a>

### Appearance/Dimensions

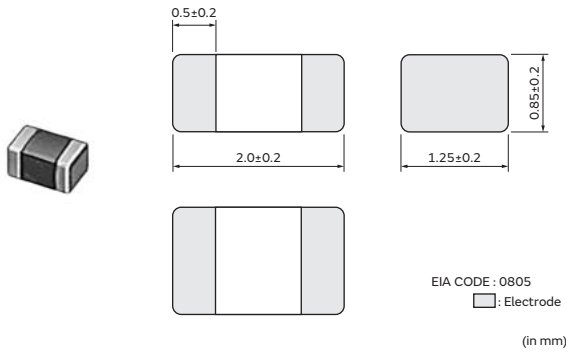

### Packaging

Code	Packaging	Minimum Quantity
D	ø180mm Paper Tape	4000
J	ø330mm Paper Tape	10000
B	Bulk(Bag)	1000

### Equivalent Circuit



(Resistance element becomes dominant at high frequencies.)

### Rated Value (□: packaging code)

Part Number		Impedance at 100MHz	Rated Current at 85°C	Rated Current at 125°C	DC Resistance (Max.)
Infotainment	Powertrain/Safety				
BLM21PG220SZ1□	BLM21PG220SH1□	22Ω±25%	6A	3.3A	0.009Ω
BLM21PG300SZ1□	BLM21PG300SH1□	30Ω(Typ.)	4A	2.3A	0.014Ω
BLM21PG600SZ1□	BLM21PG600SH1□	60Ω±25%	3.5A	1.9A	0.02Ω
BLM21PG121SZ1□	BLM21PG121SH1□	120Ω±25%	3A	1.55A	0.03Ω
BLM21PG221SZ1□	BLM21PG221SH1□	220Ω±25%	2A	1.25A	0.045Ω
BLM21PG331SZ1□	BLM21PG331SH1□	330Ω±25%	1.5A	1A	0.07Ω

Operating Temp. Range: -55°C to 125°C

### Z-f characteristics

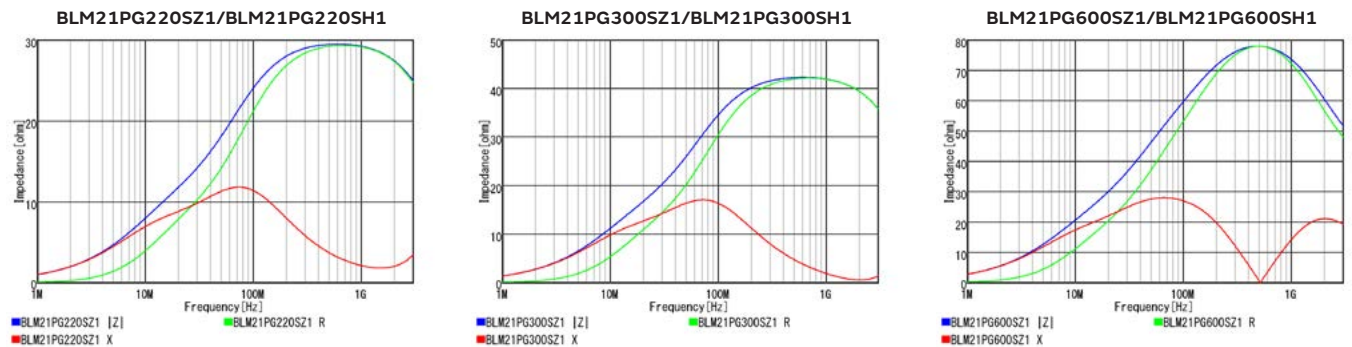

Continued on the following page. ↗



Continued from the preceding page. ↘

## Z-f characteristics

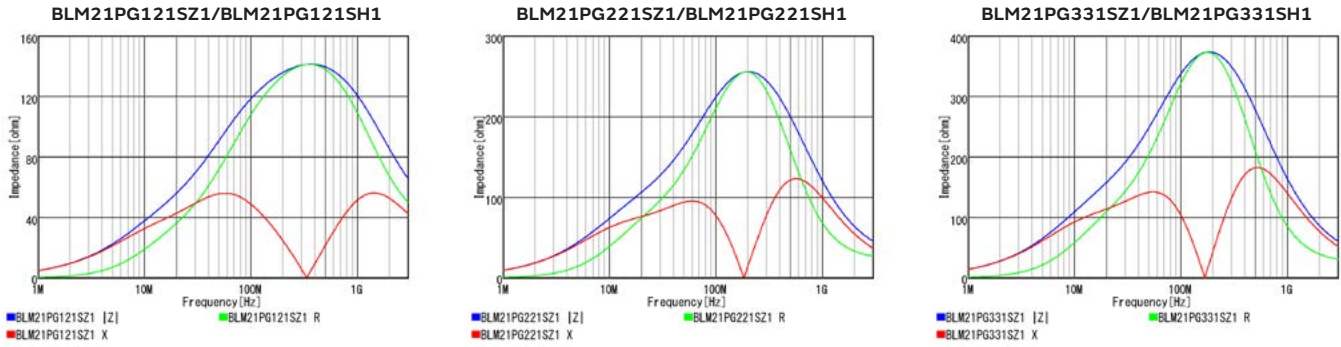

## Derating of Rated Current

In operating temperature exceeding +85°C, derating of current is necessary for BLM21PG series. Please apply the derating curve shown in chart according to the operating temperature.

Derating of Rated Current

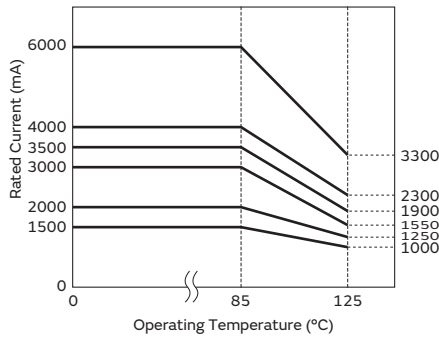

Chip Ferrite Bead

Chip EMIFIL

Chip Common Mode Choke Coil

Block Type EMIFIL

Microchip Transformer (Ballun)

Inductors for Power Lines

Inductors for General Circuits

RF Inductors

# Chip Ferrite Bead SMD Type

## BLM21PG(150°C Available) Series 0805/2012(inch/mm)

### Specifications Sheet (with cautions/mounting/packaging)

Infotainment	—
Powertrain/Safety	<a href="https://www.murata.com/products/productdata/8798462967838/QNFA9131.pdf?1608273989000">https://www.murata.com/products/productdata/8798462967838/QNFA9131.pdf?1608273989000</a>

### Appearance/Dimensions

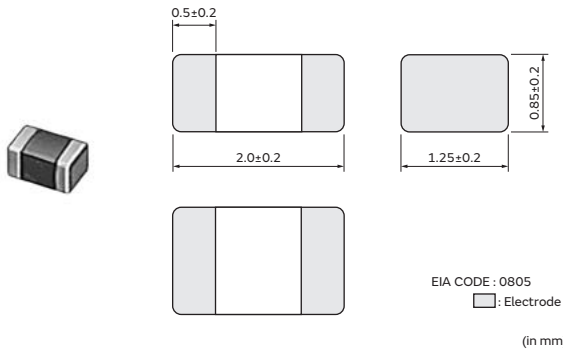

### Packaging

Code	Packaging	Minimum Quantity
D	ø180mm Paper Tape	4000
J	ø330mm Paper Tape	10000
B	Bulk(Bag)	1000

### Equivalent Circuit



(Resistance element becomes dominant at high frequencies.)

### Rated Value (□: packaging code)

Part Number		Impedance at 100MHz	Rated Current at 85°C	DC Resistance (Max.)
Infotainment	Powertrain/Safety			
—	BLM21PG220BH1□	22Ω±25%	3.3A	0.009Ω
—	BLM21PG300BH1□	30Ω(Typ.)	2.3A	0.014Ω
—	BLM21PG600BH1□	60Ω±25%	1.9A	0.02Ω
—	BLM21PG121BH1□	120Ω±25%	1.55A	0.03Ω
—	BLM21PG221BH1□	220Ω±25%	1.25A	0.045Ω
—	BLM21PG331BH1□	330Ω±25%	1A	0.07Ω

Rated Current at 150°C: 10mA  
 Operating Temp. Range: -55°C to 150°C

### Z-f characteristics

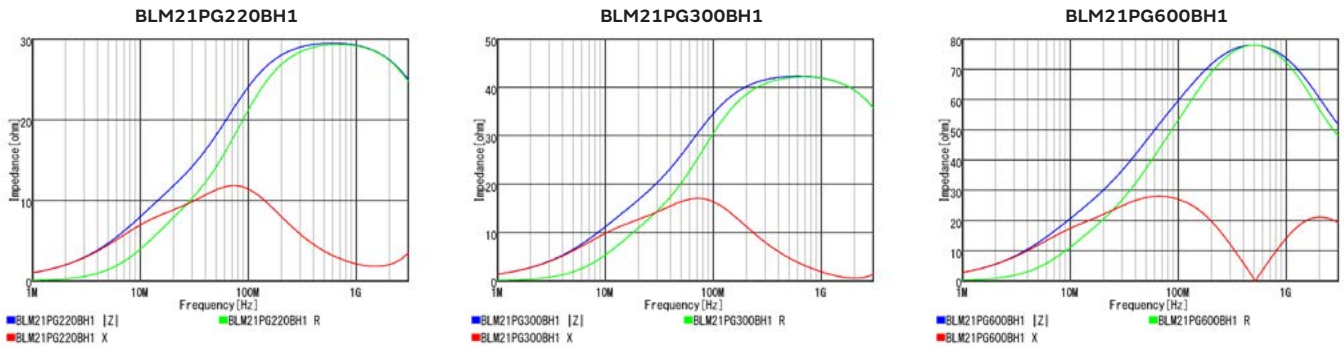

Continued on the following page. ↗

Continued from the preceding page. ↘

## Z-f characteristics

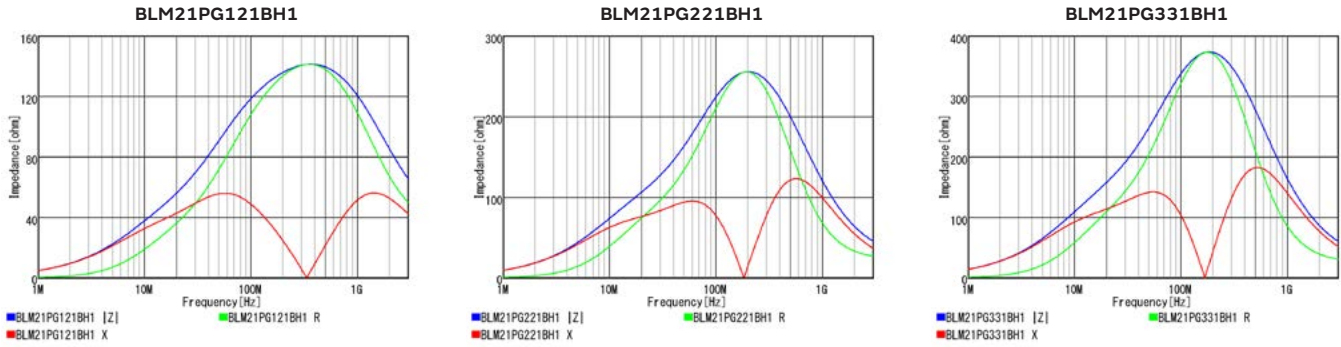

## Derating of Rated Current

In operating temperature exceeding +125°C, derating of current is necessary for BLM21PG\_BH1 series. Please apply the derating curve shown in chart according to the operating temperature.

Derating of Rated Current

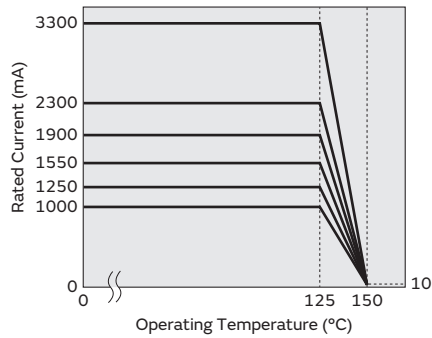

# Chip Ferrite Bead SMD Type

## BLM21SN Series 0805/2012(inch/mm)

### Specifications Sheet (with cautions/mounting/packaging)

Infotainment	<a href="https://www.murata.com/products/productdata/8796199551006/QNFA9114.pdf?1608273989000">https://www.murata.com/products/productdata/8796199551006/QNFA9114.pdf?1608273989000</a>
Powertrain/Safety	<a href="https://www.murata.com/products/productdata/8796199518238/QNFA9102.pdf?1608273989000">https://www.murata.com/products/productdata/8796199518238/QNFA9102.pdf?1608273989000</a>

### Appearance/Dimensions

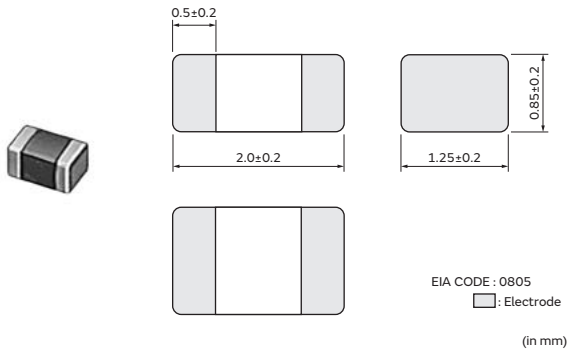

### Packaging

Code	Packaging	Minimum Quantity
D	ø180mm Paper Tape	4000
J	ø330mm Paper Tape	10000
B	Bulk(Bag)	1000

### Equivalent Circuit



(Resistance element becomes dominant at high frequencies.)

### Rated Value (: packaging code)

Part Number		Impedance at 100MHz	Rated Current at 85°C	Rated Current at 125°C	DC Resistance (Max.)	Operating Temp. Range
Infotainment	Powertrain/Safety					
<b>BLM21SN300SZ1</b> □	<b>BLM21SN300SH1</b> □	30Ω±10Ω	8.5A	6A	0.004Ω	-55°C to 125°C

### Z-f characteristics

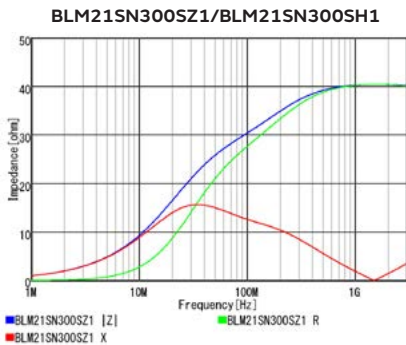

### Derating of Rated Current

In operating temperature exceeding +85°C, derating of current is necessary for BLM21SN series. Please apply the derating curve shown in chart according to the operating temperature.

Derating of Rated Current

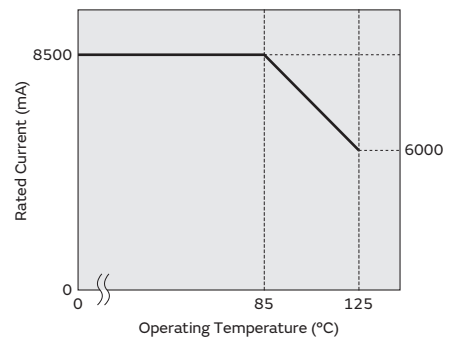

# Chip Ferrite Bead SMD Type

## BLM21SP Series 0805/2012(inch/mm)

### Specifications Sheet (with cautions/mounting/packaging)

Infotainment	<a href="https://www.murata.com/products/productdata/8796199551006/QNFA9114.pdf?1608273989000">https://www.murata.com/products/productdata/8796199551006/QNFA9114.pdf?1608273989000</a>
Powertrain/Safety	<a href="https://www.murata.com/products/productdata/8796199518238/QNFA9102.pdf?1608273989000">https://www.murata.com/products/productdata/8796199518238/QNFA9102.pdf?1608273989000</a>

### Appearance/Dimensions

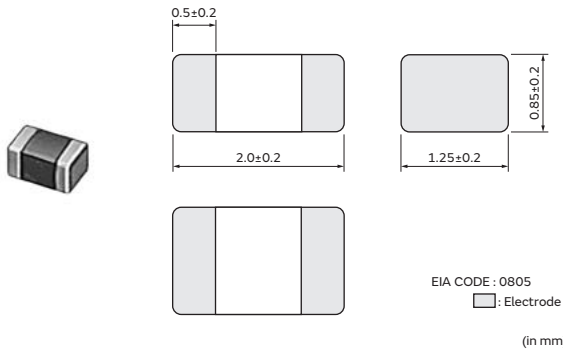

### Packaging

Code	Packaging	Minimum Quantity
D	ø180mm Paper Tape	4000
J	ø330mm Paper Tape	10000
B	Bulk(Bag)	1000

### Equivalent Circuit



(Resistance element becomes dominant at high frequencies.)

### Rated Value (□: packaging code)

Part Number		Impedance at 100MHz	Rated Current at 85°C	Rated Current at 125°C	DC Resistance (Max.)
Infotainment	Powertrain/Safety				
BLM21SP700SZ1□	BLM21SP700SH1□	70Ω±25%	6A	4A	0.009Ω
BLM21SP111SZ1□	BLM21SP111SH1□	110Ω±25%	5A	3.3A	0.013Ω
BLM21SP181SZ1□	BLM21SP181SH1□	180Ω±25%	4A	2.6A	0.02Ω
BLM21SP331SZ1□	BLM21SP331SH1□	330Ω±25%	2.8A	1.9A	0.04Ω
BLM21SP471SZ1□	BLM21SP471SH1□	470Ω±25%	2.5A	1.7A	0.05Ω
BLM21SP601SZ1□	BLM21SP601SH1□	600Ω±25%	2.3A	1.5A	0.06Ω
BLM21SP102SZ1□	BLM21SP102SH1□	1000Ω±25%	1.6A	1.1A	0.12Ω

Operating Temp. Range: -55°C to 125°C

### Z-f characteristics

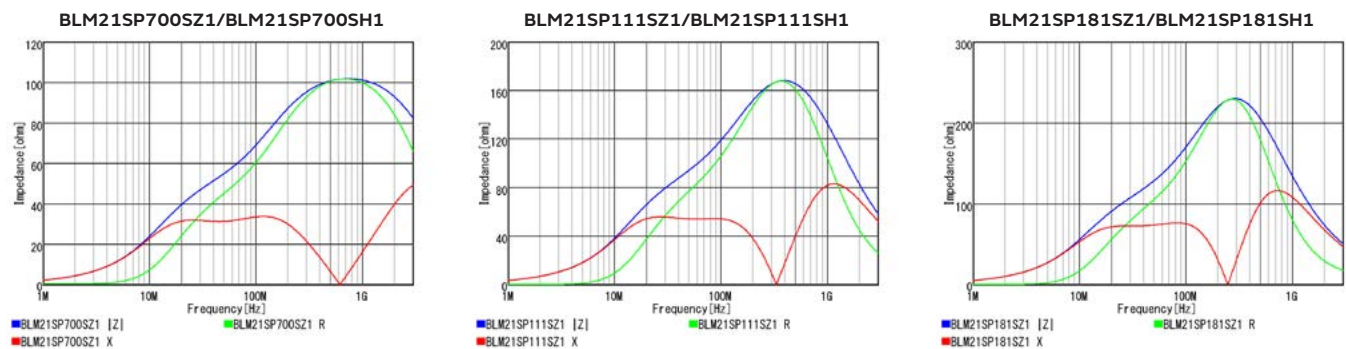

Continued on the following page. ↗

Continued from the preceding page. ↘

## Z-f characteristics

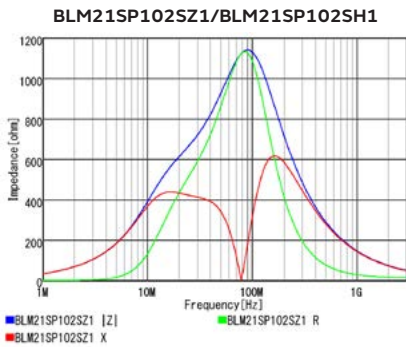
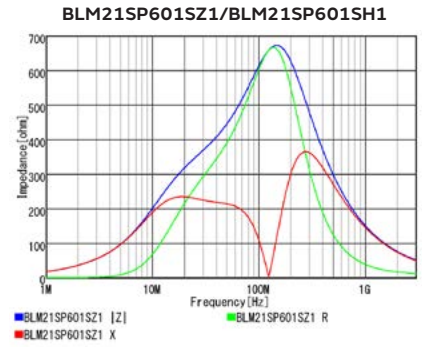
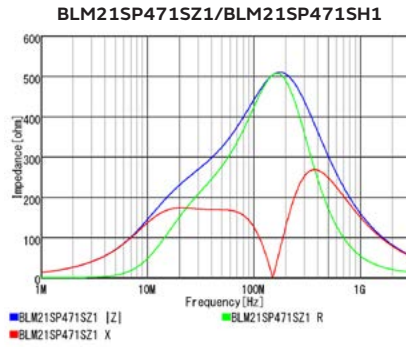
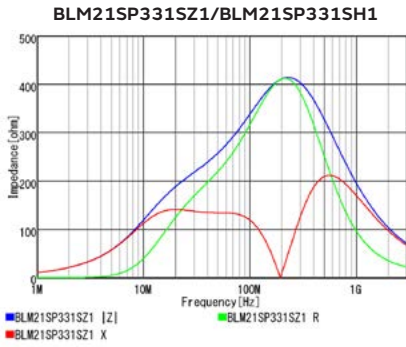

## Derating of Rated Current

In operating temperature exceeding +85°C, derating of current is necessary for BLM21SP series. Please apply the derating curve shown in chart according to the operating temperature.

Derating of Rated Current

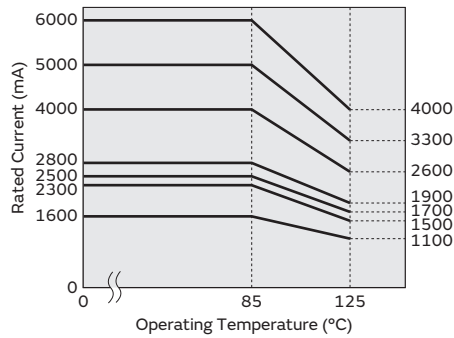

Chip Ferrite Bead

Chip EMIFIL

Chip Common Mode Choke Coil

Block Type EMIFIL

Microchip Transformer (Balun)

Inductors for Power Lines

Inductors for General Circuits

RF Inductors

# Chip Ferrite Bead SMD Type

## BLM21SP(150°C Available) Series 0805/2012(inch/mm)

### Specifications Sheet (with cautions/mounting/packaging)

Infotainment	—
Powertrain/Safety	<a href="https://www.murata.com/products/productdata/8798462967838/QNFA9131.pdf?1608273989000">https://www.murata.com/products/productdata/8798462967838/QNFA9131.pdf?1608273989000</a>

### Appearance/Dimensions

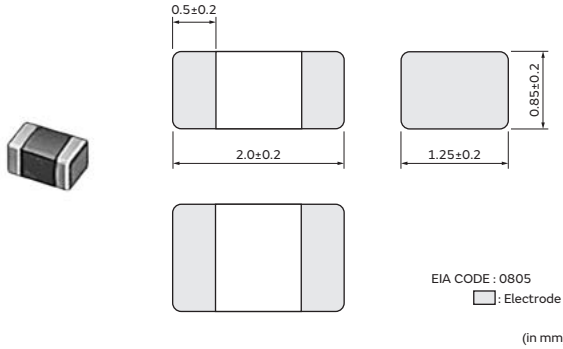

### Packaging

Code	Packaging	Minimum Quantity
D	ø180mm Paper Tape	4000
J	ø330mm Paper Tape	10000
B	Bulk(Bag)	1000

### Equivalent Circuit

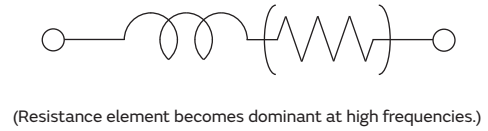

### Rated Value (□: packaging code)

Part Number		Impedance at 100MHz	Rated Current at 85°C	DC Resistance (Max.)
Infotainment	Powertrain/Safety			
—	BLM21SP700BH1□	70Ω±25%	6A	0.009Ω
—	BLM21SP111BH1□	110Ω±25%	5A	0.013Ω
—	BLM21SP181BH1□	180Ω±25%	4A	0.02Ω
—	BLM21SP331BH1□	330Ω±25%	2.8A	0.04Ω
—	BLM21SP471BH1□	470Ω±25%	2.5A	0.05Ω
—	BLM21SP601BH1□	600Ω±25%	2.3A	0.06Ω
—	BLM21SP102BH1□	1000Ω±25%	1.6A	0.12Ω

Rated Current at 150°C: 10mA  
 Operating Temp. Range: -55°C to 150°C

### Z-f characteristics

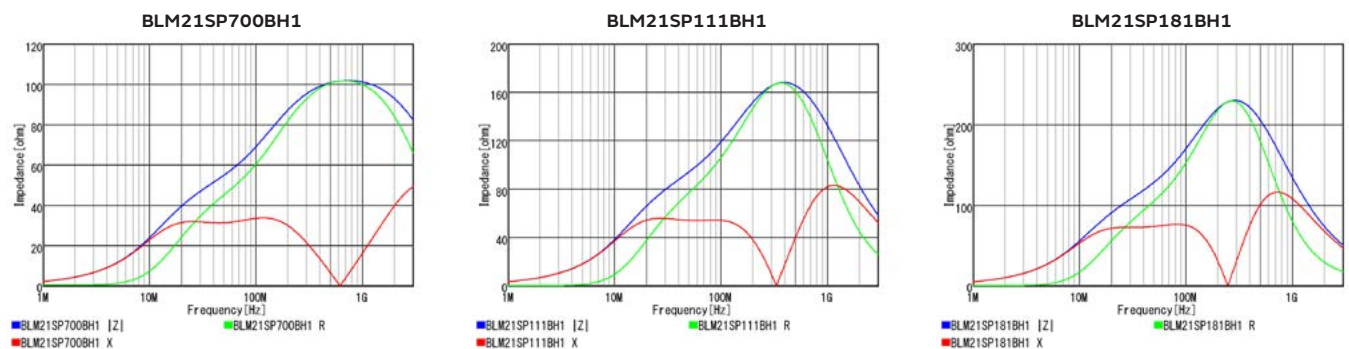

Continued on the following page. ↗



Continued from the preceding page. ↘

## Z-f characteristics

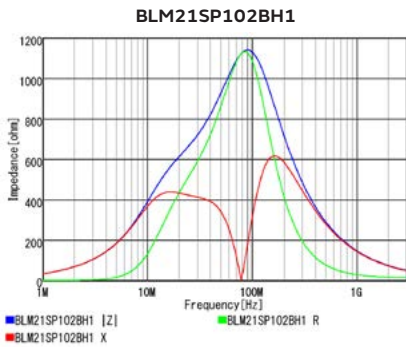
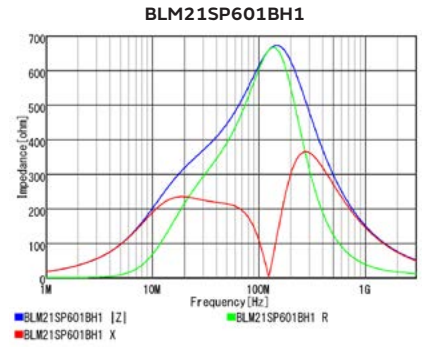
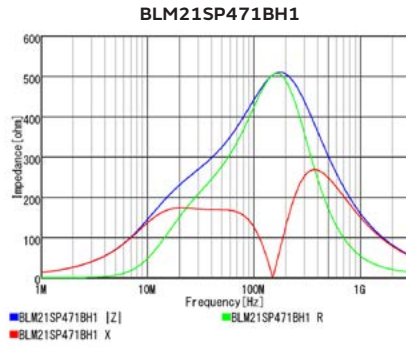
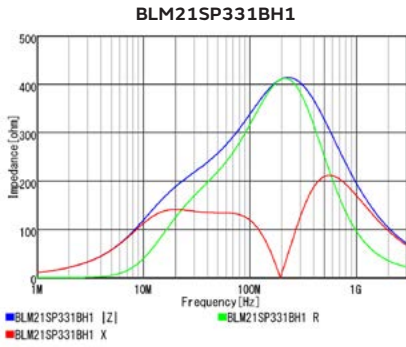

## Derating of Rated Current

In operating temperature exceeding +85°C, derating of current is necessary for BLM21SP\_BH1 series. Please apply the derating curve shown in chart according to the operating temperature.

Derating of Rated Current

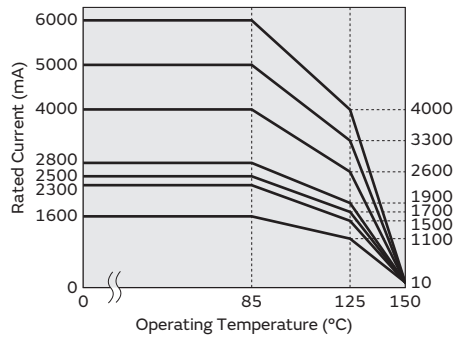

Chip Ferrite Bead

Chip EMIFIL

Chip Common Mode Choke Coil

Block Type EMIFIL

Microchip Transformer (Balun)

Inductors for Power Lines

Inductors for General Circuits

RF Inductors

# Chip Ferrite Bead SMD Type

## BLM21AG Series 0805/2012(inch/mm)

### Specifications Sheet (with cautions/mounting/packaging)

Infotainment	<a href="https://www.murata.com/products/productdata/8796199551006/QNFA9114.pdf?1608273989000">https://www.murata.com/products/productdata/8796199551006/QNFA9114.pdf?1608273989000</a>
Powertrain/Safety	<a href="https://www.murata.com/products/productdata/8796199518238/QNFA9102.pdf?1608273989000">https://www.murata.com/products/productdata/8796199518238/QNFA9102.pdf?1608273989000</a>

### Appearance/Dimensions

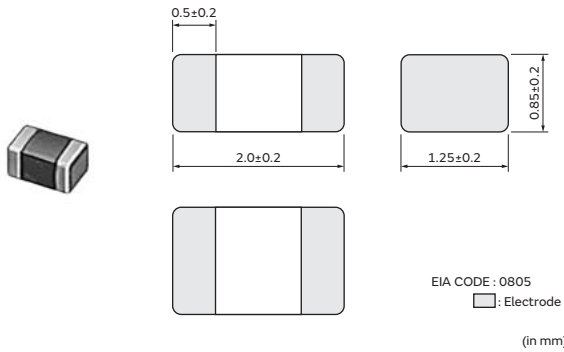

### Packaging

Code	Packaging	Minimum Quantity
D	ø180mm Paper Tape	4000
J	ø330mm Paper Tape	10000
B	Bulk(Bag)	1000

### Equivalent Circuit



(Resistance element becomes dominant at high frequencies.)

### Rated Value (□: packaging code)

Part Number		Impedance at 100MHz	Rated Current at 85°C	Rated Current at 125°C	DC Resistance (Max.)
Infotainment	Powertrain/Safety				
BLM21AG121SZ1□	BLM21AG121SH1□	120Ω±25%	1A	1A	0.09Ω
BLM21AG151SZ1□	BLM21AG151SH1□	150Ω±25%	1A	1A	0.09Ω
BLM21AG221SZ1□	BLM21AG221SH1□	220Ω±25%	900mA	900mA	0.12Ω
BLM21AG331SZ1□	BLM21AG331SH1□	330Ω±25%	800mA	800mA	0.15Ω
BLM21AG471SZ1□	BLM21AG471SH1□	470Ω±25%	700mA	700mA	0.18Ω
BLM21AG601SZ1□	BLM21AG601SH1□	600Ω±25%	700mA	700mA	0.2Ω
BLM21AG102SZ1□	BLM21AG102SH1□	1000Ω±25%	600mA	600mA	0.27Ω

Operating Temp. Range: -55°C to 125°C

### Z-f characteristics

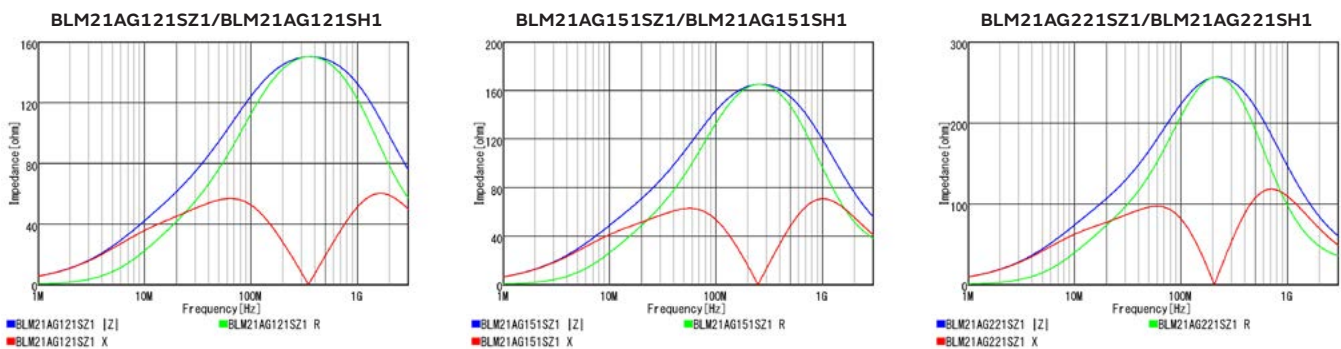

Continued on the following page. ↗

Continued from the preceding page. ↘

## Z-f characteristics

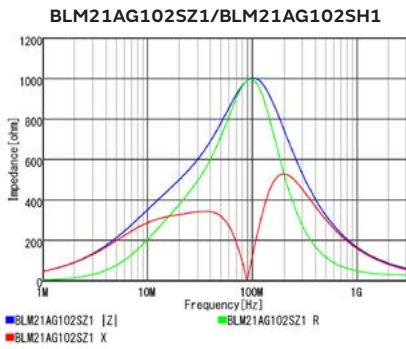
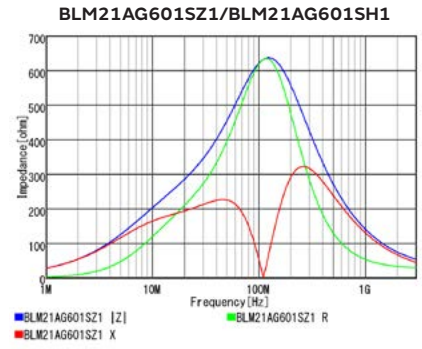
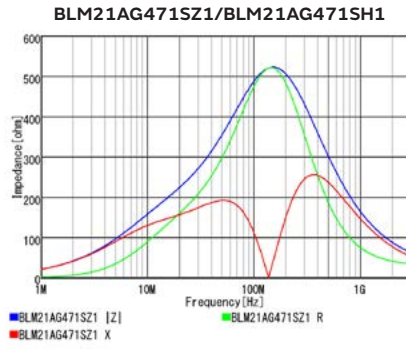
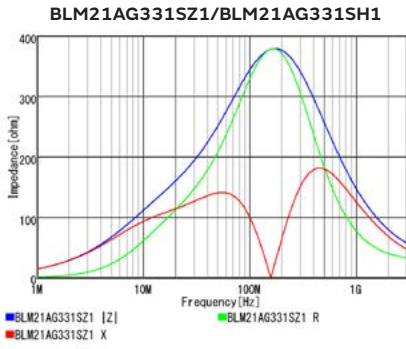

Chip Ferrite Bead

Chip EMIFIL

Chip Common Mode Choke Coil

Block Type EMIFIL

Microchip Transformer (Balun)

Inductors for Power Lines

Inductors for General Circuits

RF Inductors

# Chip Ferrite Bead SMD Type

## BLM21AG(150°C Available) Series 0805/2012(inch/mm)

### Specifications Sheet (with cautions/mounting/packaging)

Infotainment	—
Powertrain/Safety	<a href="https://www.murata.com/products/productdata/8798462967838/QNFA9131.pdf?1608273989000">https://www.murata.com/products/productdata/8798462967838/QNFA9131.pdf?1608273989000</a>

### Appearance/Dimensions

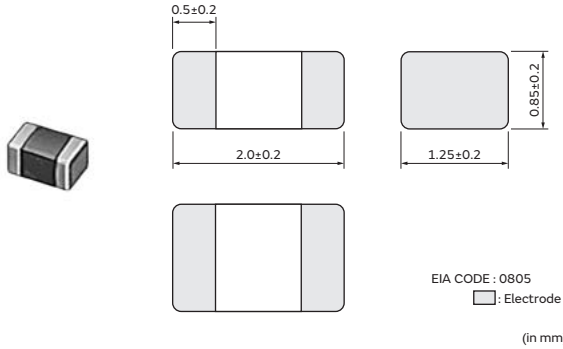

### Packaging

Code	Packaging	Minimum Quantity
D	ø180mm Paper Tape	4000
J	ø330mm Paper Tape	10000
B	Bulk(Bag)	1000

### Equivalent Circuit

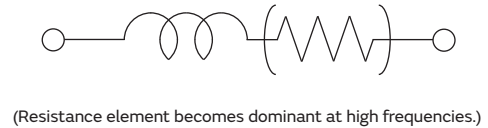

### Rated Value (□: packaging code)

Part Number		Impedance at 100MHz	Rated Current at 85°C	DC Resistance (Max.)
Infotainment	Powertrain/Safety			
—	BLM21AG121BH1□	120Ω±25%	1A	0.09Ω
—	BLM21AG151BH1□	150Ω±25%	1A	0.09Ω
—	BLM21AG221BH1□	220Ω±25%	900mA	0.12Ω
—	BLM21AG331BH1□	330Ω±25%	800mA	0.15Ω
—	BLM21AG471BH1□	470Ω±25%	700mA	0.18Ω
—	BLM21AG601BH1□	600Ω±25%	700mA	0.2Ω
—	BLM21AG102BH1□	1000Ω±25%	600mA	0.27Ω

Rated Current at 150°C: 10mA  
 Operating Temp. Range: -55°C to 150°C

### Z-f characteristics

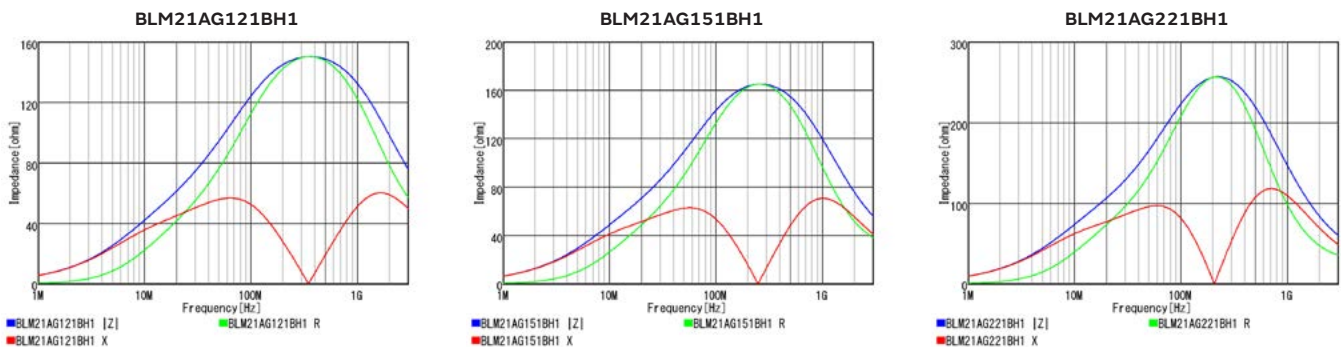

Continued on the following page. ↗

Continued from the preceding page. ↘

## Z-f characteristics

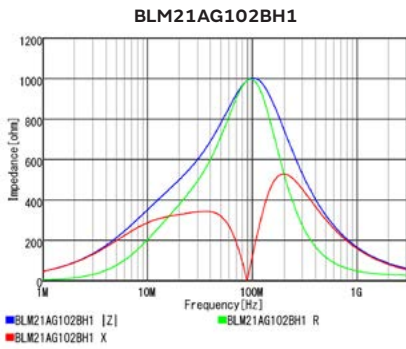
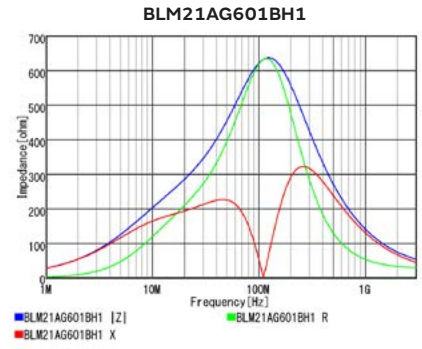
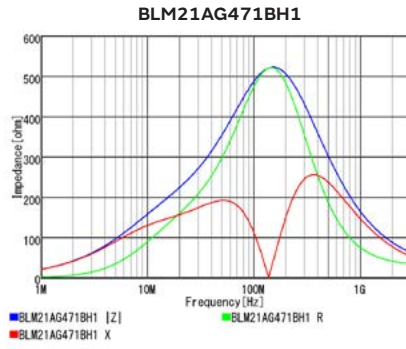
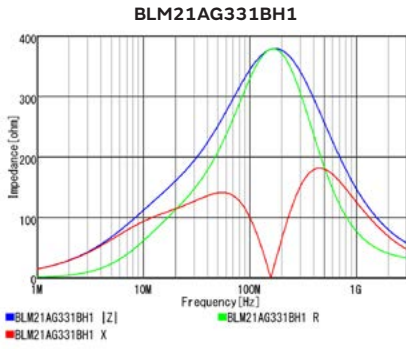

## Derating of Rated Current

In operating temperature exceeding +125°C, derating of current is necessary for BLM21AG\_BH1 series. Please apply the derating curve shown in chart according to the operating temperature.

Derating of Rated Current

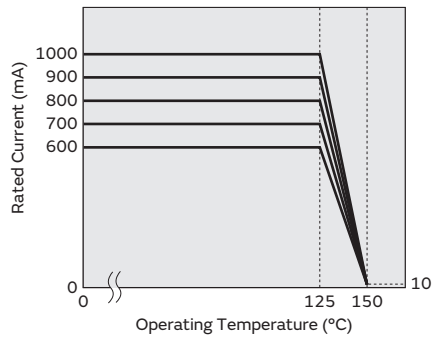

# Chip Ferrite Bead SMD Type

## BLM21BB Series 0805/2012(inch/mm)

### Specifications Sheet (with cautions/mounting/packaging)

Infotainment	<a href="https://www.murata.com/products/productdata/8796199551006/QNFA9114.pdf?1608273989000">https://www.murata.com/products/productdata/8796199551006/QNFA9114.pdf?1608273989000</a>
Powertrain/Safety	<a href="https://www.murata.com/products/productdata/8796199518238/QNFA9102.pdf?1608273989000">https://www.murata.com/products/productdata/8796199518238/QNFA9102.pdf?1608273989000</a>

### Appearance/Dimensions

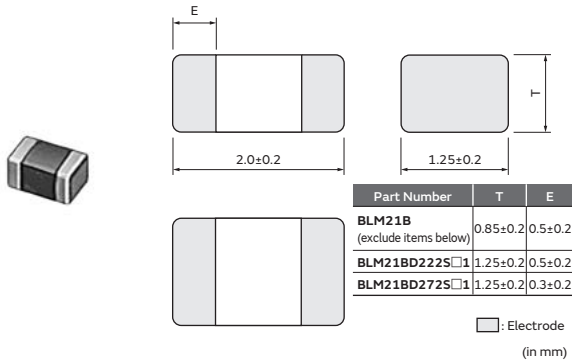

### Packaging

Code	Packaging	Minimum Quantity
D	ø180mm Paper Tape	4000
J	ø330mm Paper Tape	10000
B	Bulk(Bag)	1000

### Equivalent Circuit



(Resistance element becomes dominant at high frequencies.)

### Rated Value (□: packaging code)

Part Number		Impedance at 100MHz	Rated Current at 85°C	Rated Current at 125°C	DC Resistance (Max.)
Infotainment	Powertrain/Safety				
BLM21BB050SZ1□	BLM21BB050SH1□	5Ω±25%	1A	1A	0.02Ω
BLM21BB600SZ1□	BLM21BB600SH1□	60Ω±25%	800mA	800mA	0.13Ω
BLM21BB750SZ1□	BLM21BB750SH1□	75Ω±25%	700mA	700mA	0.16Ω
BLM21BB121SZ1□	BLM21BB121SH1□	120Ω±25%	600mA	600mA	0.19Ω
BLM21BB151SZ1□	BLM21BB151SH1□	150Ω±25%	600mA	600mA	0.21Ω
BLM21BB201SZ1□	BLM21BB201SH1□	200Ω±25%	500mA	500mA	0.26Ω
BLM21BB221SZ1□	BLM21BB221SH1□	220Ω±25%	500mA	500mA	0.26Ω
BLM21BB331SZ1□	BLM21BB331SH1□	330Ω±25%	400mA	400mA	0.33Ω
BLM21BB471SZ1□	BLM21BB471SH1□	470Ω±25%	400mA	400mA	0.4Ω

Operating Temp. Range: -55°C to 125°C

### Z-f characteristics

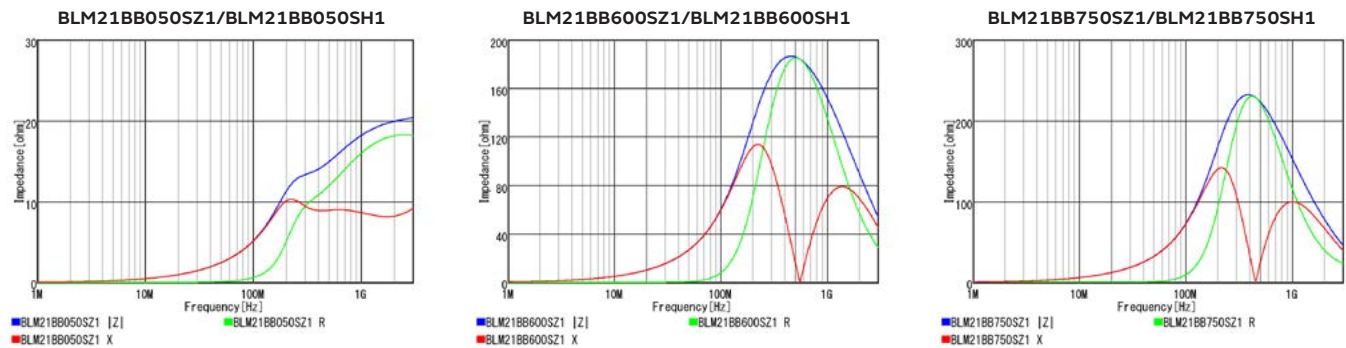

Continued on the following page. ↗

Continued from the preceding page. ↘

## Z-f characteristics

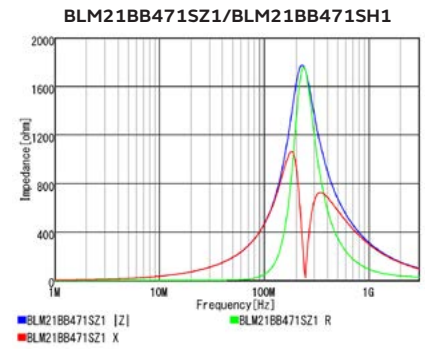
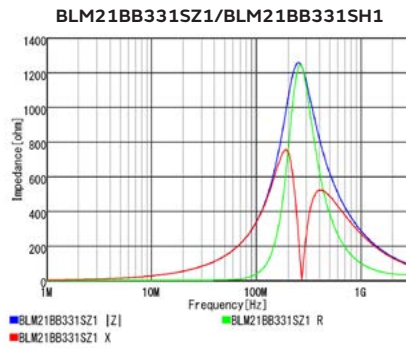
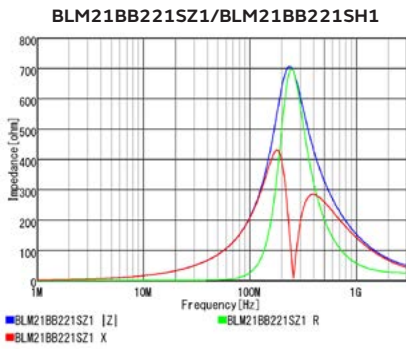
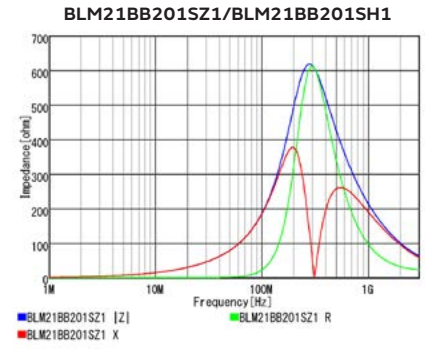
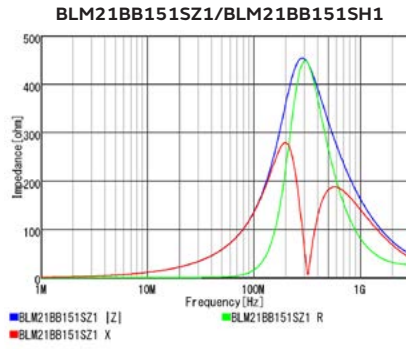
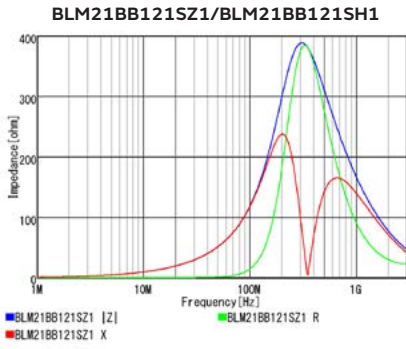

Chip Ferrite Bead

Chip EMIFIL

Chip Common Mode Choke Coil

Block Type EMIFIL

Microchip Transformer (Balun)

Inductors for Power Lines

Inductors for General Circuits

RF Inductors



# Chip Ferrite Bead SMD Type

## BLM21BD Series 0805/2012(inch/mm)

### Specifications Sheet (with cautions/mounting/packaging)

Infotainment	<a href="https://www.murata.com/products/productdata/8796199551006/QNFA9114.pdf?1608273989000">https://www.murata.com/products/productdata/8796199551006/QNFA9114.pdf?1608273989000</a>
Powertrain/Safety	<a href="https://www.murata.com/products/productdata/8796199518238/QNFA9102.pdf?1608273989000">https://www.murata.com/products/productdata/8796199518238/QNFA9102.pdf?1608273989000</a>

### Appearance/Dimensions

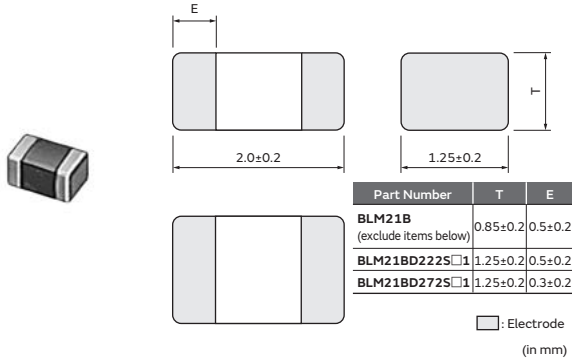

### Packaging

All except for BLM21BD222SZ1/BLM21BD222SH1/BLM21BD272SZ1/BLM21BD272SH1

Code	Packaging	Minimum Quantity
D	ø180mm Paper Tape	4000
J	ø330mm Paper Tape	10000
B	Bulk(Bag)	1000

BLM21BD222SZ1/BLM21BD222SH1/BLM21BD272SZ1/BLM21BD272SH1 only

Code	Packaging	Minimum Quantity
K	ø330mm Embossed Tape	10000
L	ø180mm Embossed Tape	3000
B	Bulk(Bag)	1000

### Equivalent Circuit



(Resistance element becomes dominant at high frequencies.)

### Rated Value (□: packaging code)

Part Number		Impedance at 100MHz	Rated Current at 85°C	Rated Current at 125°C	DC Resistance (Max.)
Infotainment	Powertrain/Safety				
BLM21BD121SZ1□	BLM21BD121SH1□	120Ω±25%	350mA	350mA	0.25Ω
BLM21BD151SZ1□	BLM21BD151SH1□	150Ω±25%	350mA	350mA	0.25Ω
BLM21BD221SZ1□	BLM21BD221SH1□	220Ω±25%	350mA	350mA	0.25Ω
BLM21BD331SZ1□	BLM21BD331SH1□	330Ω±25%	300mA	300mA	0.3Ω
BLM21BD421SZ1□	BLM21BD421SH1□	420Ω±25%	300mA	300mA	0.3Ω
BLM21BD471SZ1□	BLM21BD471SH1□	470Ω±25%	300mA	300mA	0.35Ω
BLM21BD601SZ1□	BLM21BD601SH1□	600Ω±25%	300mA	300mA	0.35Ω
BLM21BD751SZ1□	BLM21BD751SH1□	750Ω±25%	250mA	250mA	0.4Ω
BLM21BD102SZ1□	BLM21BD102SH1□	1000Ω±25%	250mA	250mA	0.4Ω
BLM21BD152SZ1□	BLM21BD152SH1□	1500Ω±25%	250mA	250mA	0.45Ω
BLM21BD182SZ1□	BLM21BD182SH1□	1800Ω±25%	250mA	250mA	0.5Ω
BLM21BD222T□1	BLM21BD222TH1□	2200Ω±25%	200mA	200mA	0.6Ω
BLM21BD222SZ1□	BLM21BD222SH1□	2250Ω(Typ.)	250mA	250mA	0.6Ω
BLM21BD272SZ1□	BLM21BD272SH1□	2700Ω±25%	200mA	200mA	0.8Ω

Operating Temp. Range: -55°C to 125°C

Continued on the following page. ↗

Continued from the preceding page. ↘

## Z-f characteristics

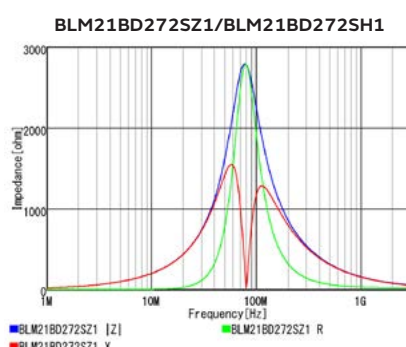
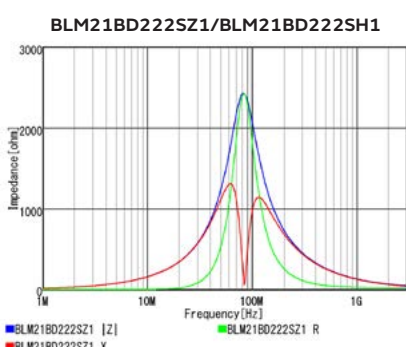
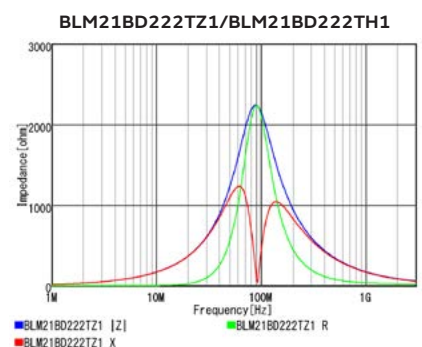
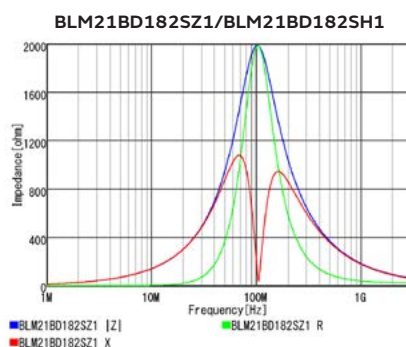
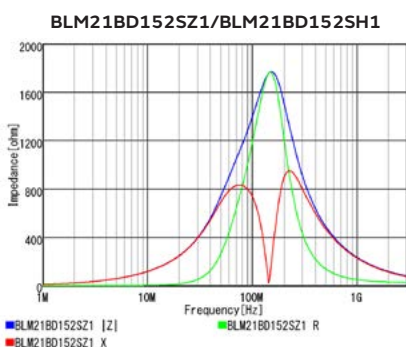
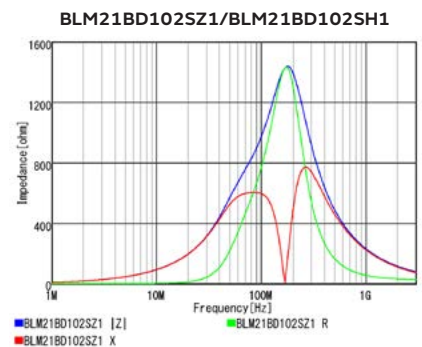
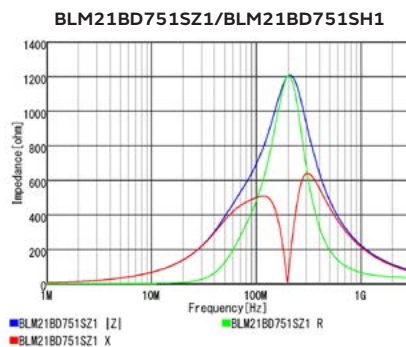
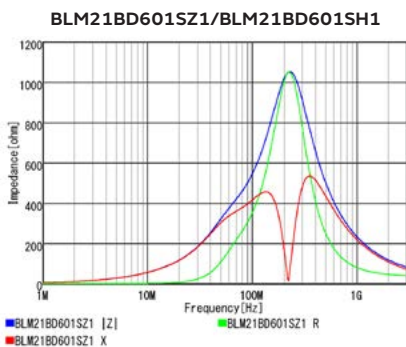
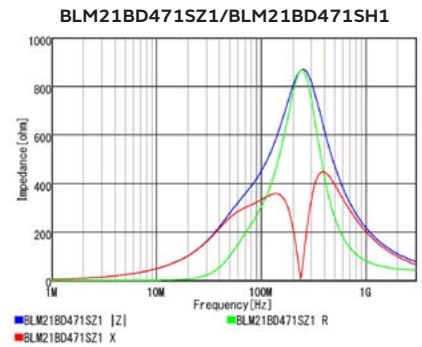
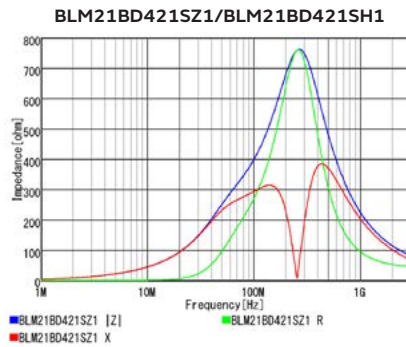
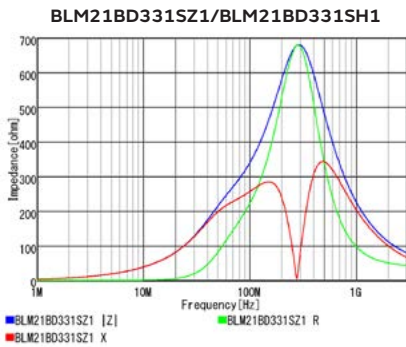
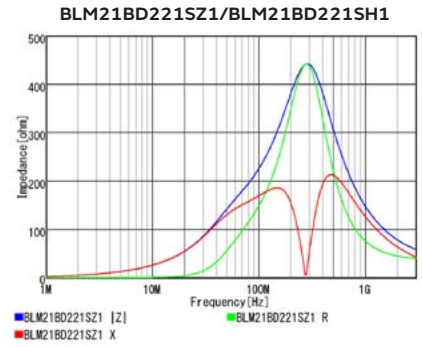
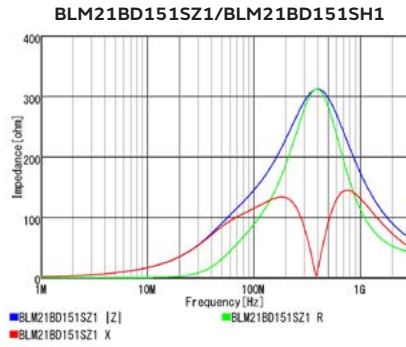
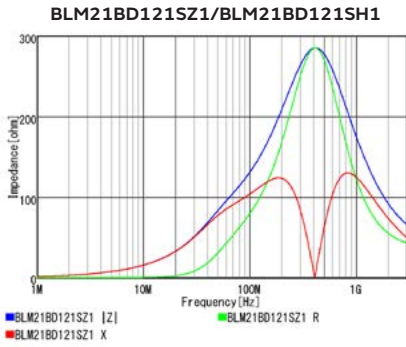

# Chip Ferrite Bead SMD Type

## BLM31PG Series 1206/3216(inch/mm)

### Specifications Sheet (with cautions/mounting/packaging)

Infotainment	<a href="https://www.murata.com/products/productdata/8796199616542/QNFA9115.pdf?1539737628000">https://www.murata.com/products/productdata/8796199616542/QNFA9115.pdf?1539737628000</a>
Powertrain/Safety	<a href="https://www.murata.com/products/productdata/8796199583774/QNFA9105.pdf?1589424697000">https://www.murata.com/products/productdata/8796199583774/QNFA9105.pdf?1589424697000</a>

### Appearance/Dimensions

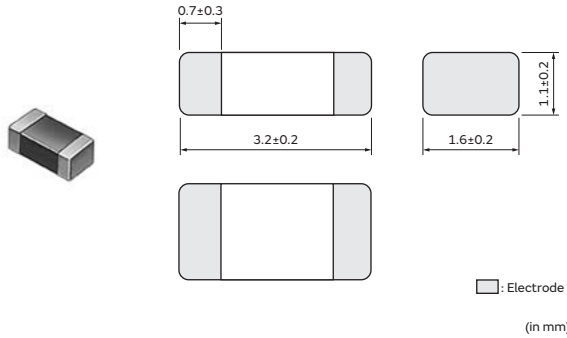

### Packaging

Code	Packaging	Minimum Quantity
K	ø330mm Embossed Tape	10000
L	ø180mm Embossed Tape	3000
B	Bulk(Bag)	1000

### Equivalent Circuit



(Resistance element becomes dominant at high frequencies.)

### Rated Value (□: packaging code)

Part Number		Impedance at 100MHz	Rated Current at 85°C	Rated Current at 125°C	DC Resistance (Max.)
Infotainment	Powertrain/Safety				
BLM31PG330SZ1□	BLM31PG330SH1□	33Ω±25%	6A	3.5A	0.009Ω
BLM31PG500SZ1□	BLM31PG500SH1□	50Ω(Typ.)	3.5A	2.3A	0.015Ω
BLM31PG121SZ1□	BLM31PG121SH1□	120Ω±25%	3.5A	2A	0.02Ω
BLM31PG391SZ1□	BLM31PG391SH1□	390Ω±25%	2A	1.25A	0.05Ω
BLM31PG601SZ1□	BLM31PG601SH1□	600Ω±25%	1.5A	1A	0.08Ω

Operating Temp. Range: -55°C to 125°C

### Z-f characteristics

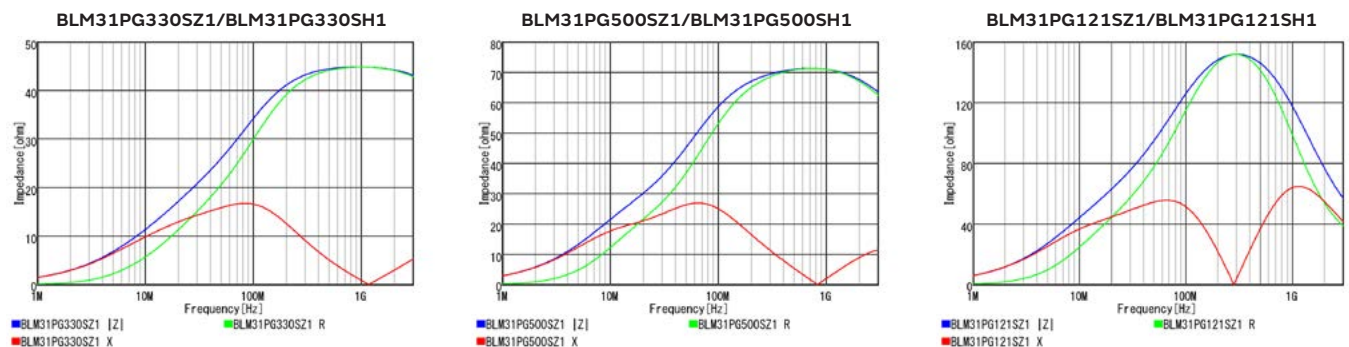

Continued on the following page. ↗

Continued from the preceding page. ↘

## Z-f characteristics

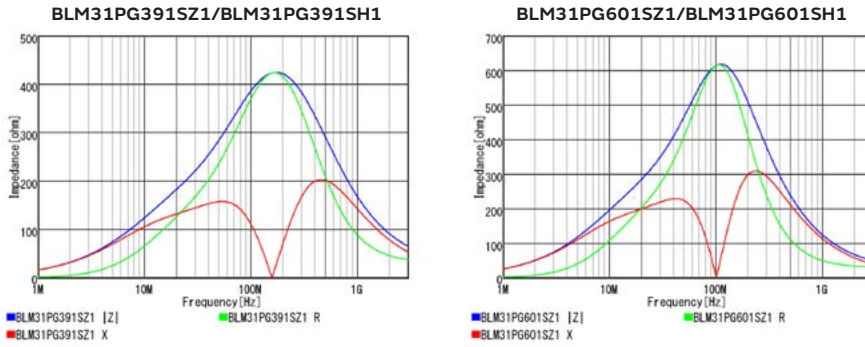

## Derating of Rated Current

In operating temperature exceeding +85°C, derating of current is necessary for BLM31PG series.  
 Please apply the derating curve shown in chart according to the operating temperature.

Derating of Rated Current

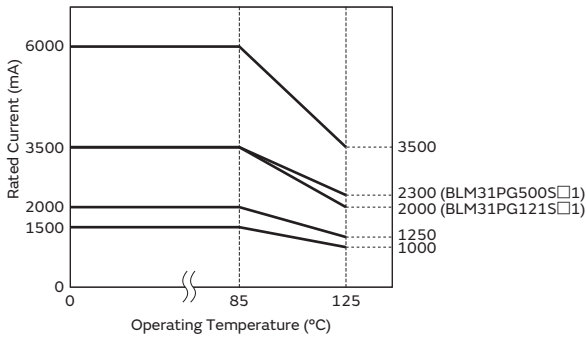

Chip Ferrite Bead

Chip EMIFIL

Chip Common Mode Choke Coil

Block Type EMIFIL

Microchip Transformer (Balun)

Inductors for Power Lines

Inductors for General Circuits

RF Inductors

# Chip Ferrite Bead SMD Type

## BLM31KN Series 1206/3216(inch/mm)

### Specifications Sheet (with cautions/mounting/packaging)

Infotainment	<a href="https://www.murata.com/products/productdata/8801528578078/QNFA9149.pdf?1544069236000">https://www.murata.com/products/productdata/8801528578078/QNFA9149.pdf?1544069236000</a>
Powertrain/Safety	<a href="https://www.murata.com/products/productdata/8801528643614/QNFA9148.pdf?1608273989000">https://www.murata.com/products/productdata/8801528643614/QNFA9148.pdf?1608273989000</a>

### Appearance/Dimensions

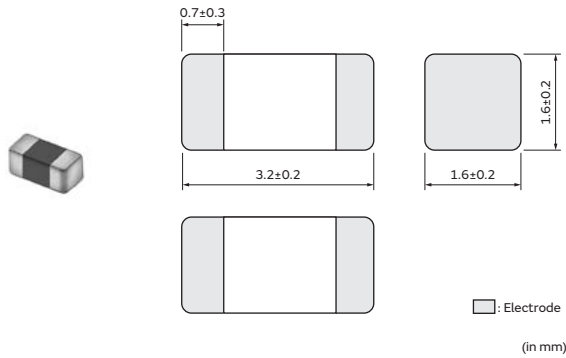

### Packaging

Code	Packaging	Minimum Quantity
K	ø330mm Embossed Tape	8000
L	ø180mm Embossed Tape	2500
B	Bulk(Bag)	1000

### Equivalent Circuit



(Resistance element becomes dominant at high frequencies.)

### Rated Value (□: packaging code)

Part Number		Impedance at 100MHz	Rated Current at 85°C	Rated Current at 125°C	DC Resistance (Max.)
Infotainment	Powertrain/Safety				
BLM31KN121SZ1□	BLM31KN121SH1□	120Ω±25%	6A	4A	0.009Ω
BLM31KN271SZ1□	BLM31KN271SH1□	270Ω±25%	4.5A	3A	0.016Ω
BLM31KN471SZ1□	BLM31KN471SH1□	470Ω±25%	4A	2.7A	0.02Ω
BLM31KN601SZ1□	BLM31KN601SH1□	600Ω±25%	2.9A	2A	0.038Ω
BLM31KN801SZ1□	BLM31KN801SH1□	800Ω±25%	2.5A	1.7A	0.05Ω
BLM31KN102SZ1□	BLM31KN102SH1□	1000Ω±25%	2A	1.4A	0.075Ω

Operating Temp. Range: -55°C to 125°C

### Z-f characteristics

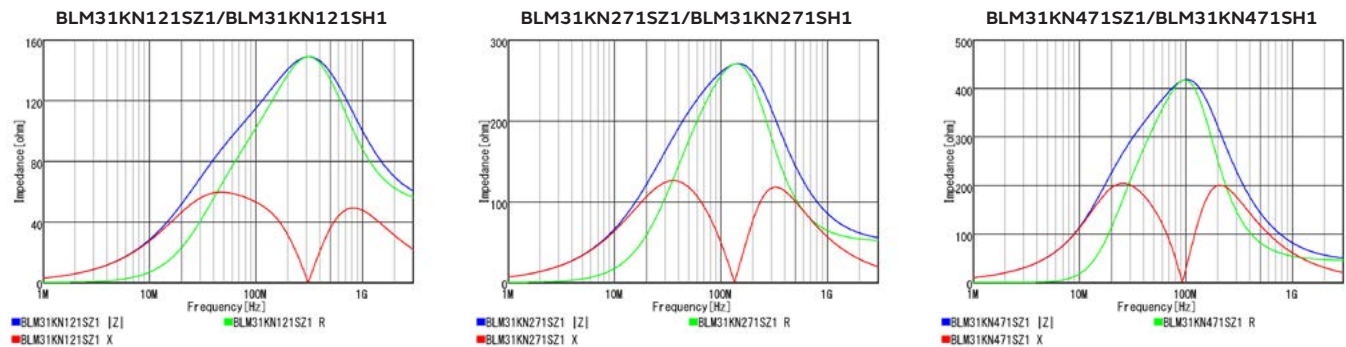

Continued on the following page. ↗

Continued from the preceding page. ↘

## Z-f characteristics

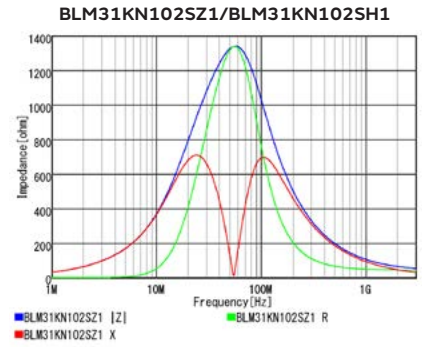
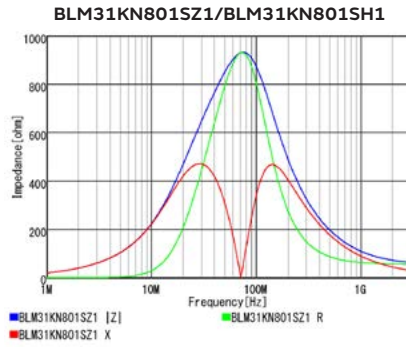
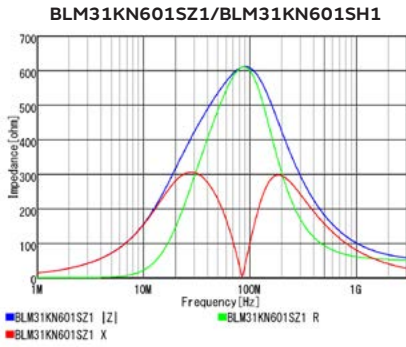

## Derating of Rated Current

In operating temperature exceeding +85°C, derating of current is necessary for BLM31KN series.  
 Please apply the derating curve shown in chart according to the operating temperature.

Derating of Rated Current

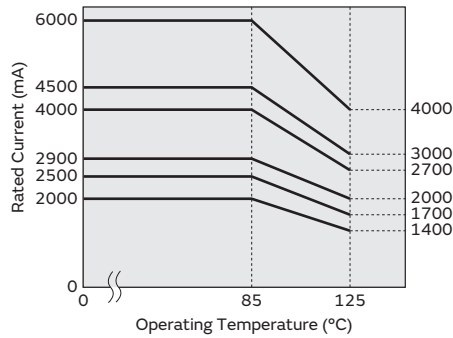



# Chip Ferrite Bead SMD Type

## BLM31KN(150°C Available) Series 1206/3216(inch/mm)

### Specifications Sheet (with cautions/mounting/packaging)

Infotainment	—
Powertrain/Safety	<a href="https://www.murata.com/products/productdata/8800167198750/QNFA9138.pdf?1544069236000">https://www.murata.com/products/productdata/8800167198750/QNFA9138.pdf?1544069236000</a>

### Appearance/Dimensions

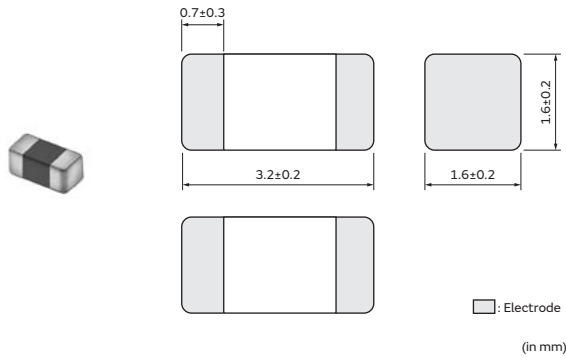

### Packaging

Code	Packaging	Minimum Quantity
K	ø330mm Embossed Tape	8000
L	ø180mm Embossed Tape	2500
B	Bulk(Bag)	1000

### Equivalent Circuit

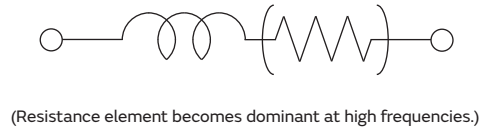

### Rated Value (□: packaging code)

Part Number		Impedance at 100MHz	Rated Current at 85°C	DC Resistance (Max.)
Infotainment	Powertrain/Safety			
—	BLM31KN121BH1□	120Ω±25%	4A	0.009Ω
—	BLM31KN271BH1□	270Ω±25%	3A	0.016Ω
—	BLM31KN471BH1□	470Ω±25%	2.7A	0.02Ω
—	BLM31KN601BH1□	600Ω±25%	2A	0.038Ω
—	BLM31KN801BH1□	800Ω±25%	1.7A	0.05Ω
—	BLM31KN102BH1□	1000Ω±25%	1.4A	0.075Ω

Rated Current at 150°C: 10mA  
 Operating Temp. Range: -55°C to 150°C

### Z-f characteristics

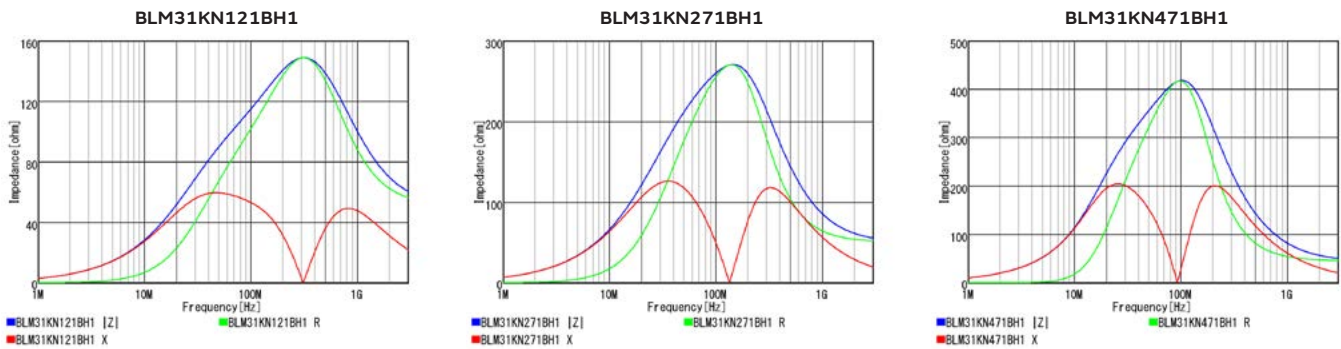

Continued on the following page. ↗



Continued from the preceding page. ↘

## Z-f characteristics

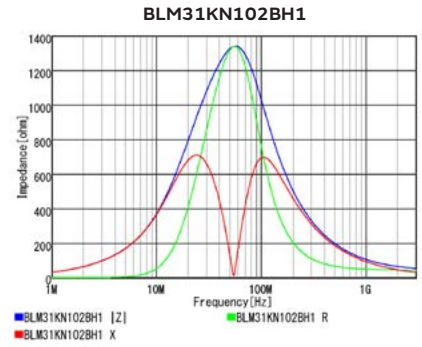
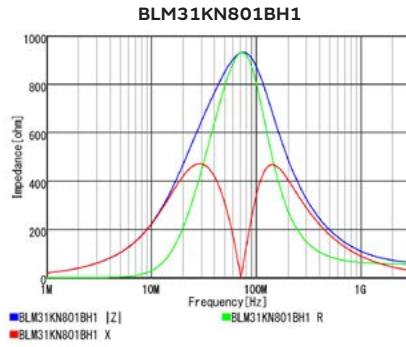
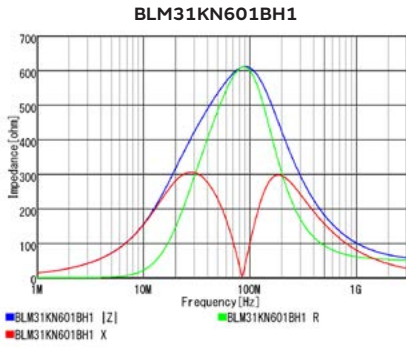

## Derating of Rated Current

In operating temperature exceeding +125°C, derating of current is necessary for BLM31KN\_BH1 series. Please apply the derating curve shown in chart according to the operating temperature.

Derating of Rated Current

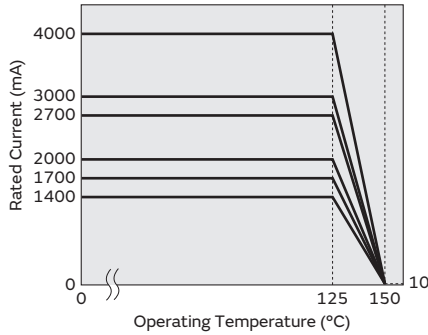

# Chip Ferrite Bead SMD Type

## BLM31SN Series 1206/3216(inch/mm)

### Specifications Sheet (with cautions/mounting/packaging)

Infotainment	<a href="https://www.murata.com/products/productdata/8796199616542/QNFA9115.pdf?1539737628000">https://www.murata.com/products/productdata/8796199616542/QNFA9115.pdf?1539737628000</a>
Powertrain/Safety	<a href="https://www.murata.com/products/productdata/8796199583774/QNFA9105.pdf?1589424697000">https://www.murata.com/products/productdata/8796199583774/QNFA9105.pdf?1589424697000</a>

### Appearance/Dimensions

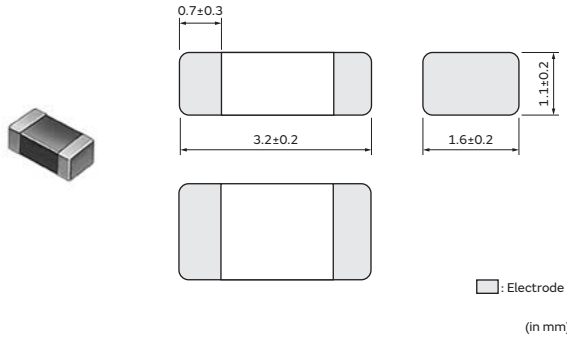

### Packaging

Code	Packaging	Minimum Quantity
L	ø180mm Embossed Tape	3000
B	Bulk(Bag)	1000

### Equivalent Circuit



(Resistance element becomes dominant at high frequencies.)

### Rated Value (□: packaging code)

Part Number		Impedance at 100MHz	Rated Current at 85°C	Rated Current at 125°C	DC Resistance (Max.)	Operating Temp. Range
Infotainment	Powertrain/Safety					
BLM31SN500SZ1□	BLM31SN500SH1□	50Ω±25%	12A	10A	0.0016Ω	-55°C to 125°C

### Z-f characteristics

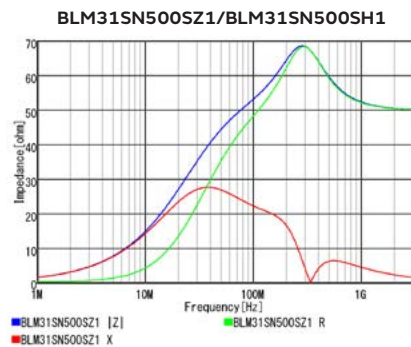

### Derating of Rated Current

In operating temperature exceeding +85°C, derating of current is necessary for BLM31SN series. Please apply the derating curve shown in chart according to the operating temperature.

Derating of Rated Current

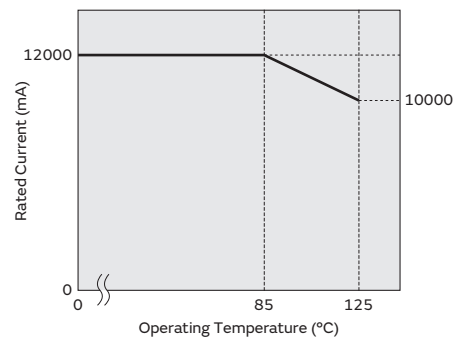

# Chip Ferrite Bead SMD Type

## BLM31AJ Series 1206/3216(inch/mm)

### Specifications Sheet (with cautions/mounting/packaging)

Infotainment	—
Powertrain/Safety	<a href="https://www.murata.com/products/productdata/8796199583774/QNFA9105.pdf?1589424697000">https://www.murata.com/products/productdata/8796199583774/QNFA9105.pdf?1589424697000</a>

### Appearance/Dimensions

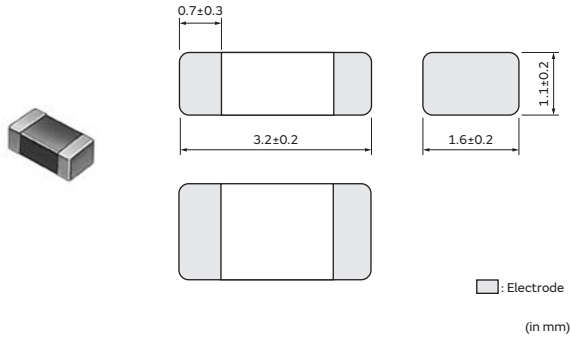

### Packaging

Code	Packaging	Minimum Quantity
K	ø330mm Embossed Tape	10000
L	ø180mm Embossed Tape	3000
B	Bulk(Bag)	1000

### Equivalent Circuit



(Resistance element becomes dominant at high frequencies.)

### Rated Value (□: packaging code)

Part Number		Impedance at 100MHz	Rated Current at 85°C	Rated Current at 125°C	DC Resistance (Max.)	Operating Temp. Range
Infotainment	Powertrain/Safety					
—	BLM31AJ601SH1□	600Ω±25%	200mA	200mA	0.9Ω	-55°C to 125°C

### Z-f characteristics

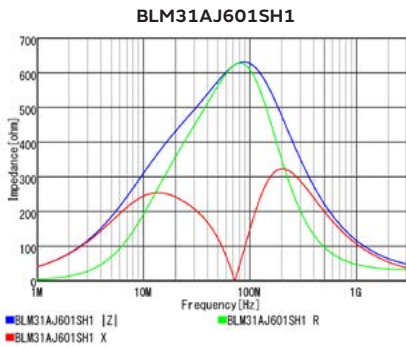

# Chip Ferrite Bead SMD Type

## BLM41PG Series 1806/4516(inch/mm)

### Specifications Sheet (with cautions/mounting/packaging)

Infotainment	<a href="https://www.murata.com/products/productdata/8796199682078/QNFA9116.pdf?1574394765000">https://www.murata.com/products/productdata/8796199682078/QNFA9116.pdf?1574394765000</a>
Powertrain/Safety	<a href="https://www.murata.com/products/productdata/8796199649310/QNFA9106.pdf?1571182763000">https://www.murata.com/products/productdata/8796199649310/QNFA9106.pdf?1571182763000</a>

### Appearance/Dimensions

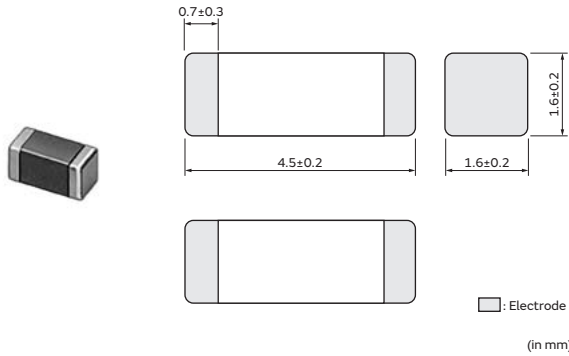

### Packaging

Code	Packaging	Minimum Quantity
K	ø330mm Embossed Tape	8000
L	ø180mm Embossed Tape	2500
B	Bulk(Bag)	1000

### Equivalent Circuit



(Resistance element becomes dominant at high frequencies.)

### Rated Value (□: packaging code)

Part Number		Impedance at 100MHz	Rated Current at 85°C	Rated Current at 125°C	DC Resistance (Max.)
Infotainment	Powertrain/Safety				
BLM41PG600SZ1□	BLM41PG600SH1□	60Ω(Typ.)	6A	3.7A	0.009Ω
BLM41PG750SZ1□	BLM41PG750SH1□	75Ω(Typ.)	3.5A	2.45A	0.015Ω
BLM41PG181SZ1□	BLM41PG181SH1□	180Ω±25%	3.5A	2.1A	0.02Ω
BLM41PG471SZ1□	BLM41PG471SH1□	470Ω±25%	2A	1.35A	0.05Ω
BLM41PG102SZ1□	BLM41PG102SH1□	1000Ω±25%	1.5A	1A	0.09Ω

Operating Temp. Range: -55°C to 125°C

### Z-f characteristics

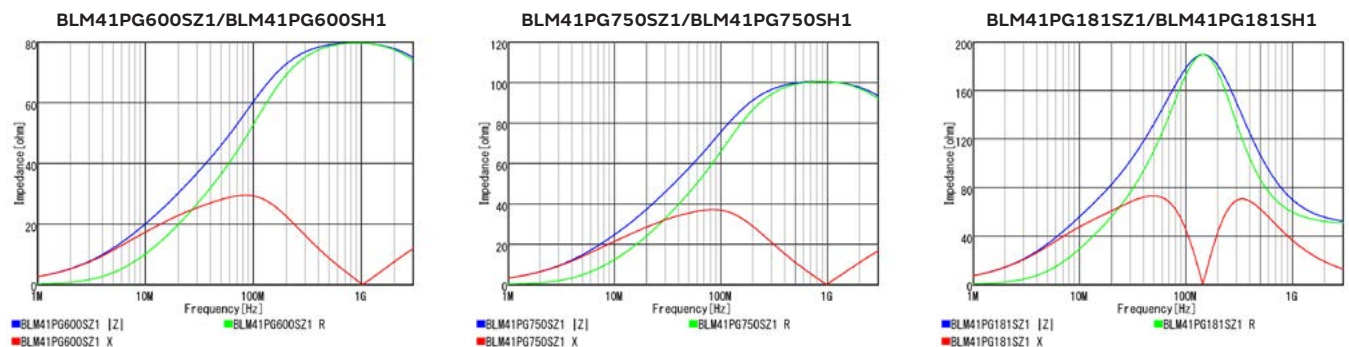

Continued on the following page. ↗

Continued from the preceding page. ↘

## Z-f characteristics

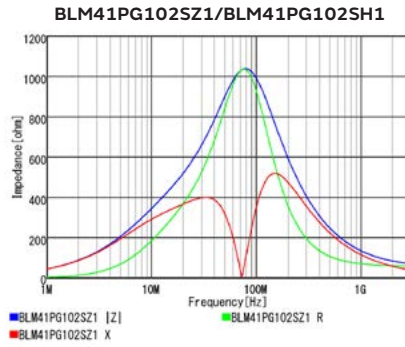
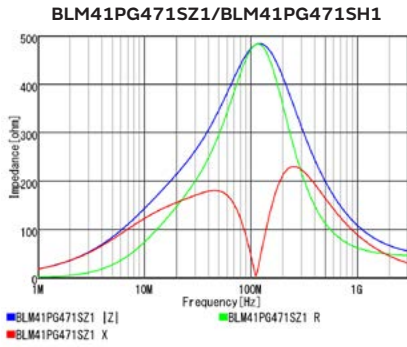

## Derating of Rated Current

In operating temperature exceeding +85°C, derating of current is necessary for BLM41PG series.  
 Please apply the derating curve shown in chart according to the operating temperature.

Derating of Rated Current

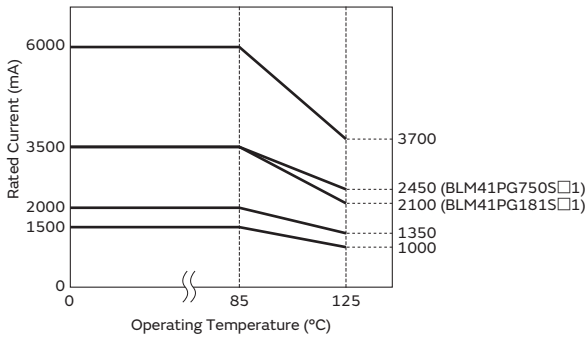

Chip Ferrite Bead

Chip EMIFIL

Chip Common Mode Choke Coil

Block Type EMIFIL

Microchip Transformer (Balun)

Inductors for Power Lines

Inductors for General Circuits

RF Inductors

# Chip Ferrite Bead SMD Type

## BLE18PS Series 0603/1608(inch/mm)

### Specifications Sheet (with cautions/mounting/packaging)

Infotainment	<a href="https://www.murata.com/products/productdata/8800167165982/QNFA9139.pdf?1608273989000">https://www.murata.com/products/productdata/8800167165982/QNFA9139.pdf?1608273989000</a>
Powertrain/Safety	<a href="https://www.murata.com/products/productdata/8800986005534/QNFA9146.pdf?1608273989000">https://www.murata.com/products/productdata/8800986005534/QNFA9146.pdf?1608273989000</a>

### Appearance/Dimensions

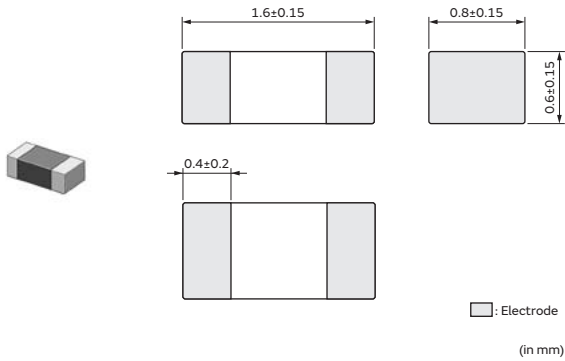

### Packaging

Code	Packaging	Minimum Quantity
D	ø180mm Paper Tape	4000
J	ø330mm Paper Tape	10000
B	Bulk(Bag)	1000

### Equivalent Circuit

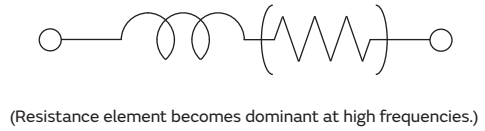

### Rated Value (□: packaging code)

Part Number		Impedance at 100MHz	Rated Current at 85°C	Rated Current at 125°C	DC Resistance (Max.)	Operating Temp. Range
Infotainment	Powertrain/Safety					
BLE18PS080SZ1□	BLE18PS080SH1□	8.5Ω±25%	8A	5A	0.004Ω	-55°C to 125°C

### Z-f characteristics

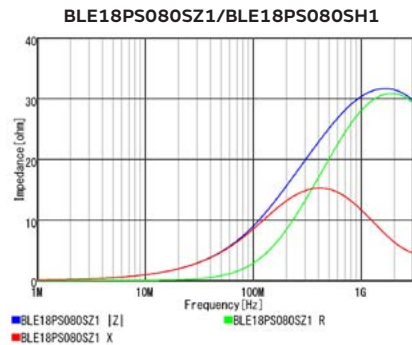

### Derating of Rated Current

In operating temperature exceeding +85°C, derating of current is necessary for BLE18PS series. Please apply the derating curve shown in chart according to the operating temperature.

#### Derating of Rated Current

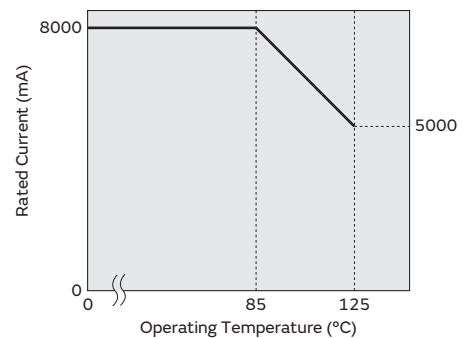

Chip Ferrite Bead  
 Chip EMIFIL  
 Chip Common Mode Choke Coil  
 Block Type EMIFIL  
 Microchip Transformer (Balun)  
 Inductors for Power Lines  
 Inductors for General Circuits  
 RF Inductors

# Chip Ferrite Bead SMD Type

# BLE18PS(150°C Available) Series 0603/1608(inch/mm)

## Specifications Sheet (with cautions/mounting/packaging)

Infotainment	—
Powertrain/Safety	<a href="https://www.murata.com/products/productdata/8800985972766/QNFA9147.pdf?1608273989000">https://www.murata.com/products/productdata/8800985972766/QNFA9147.pdf?1608273989000</a>

### Appearance/Dimensions

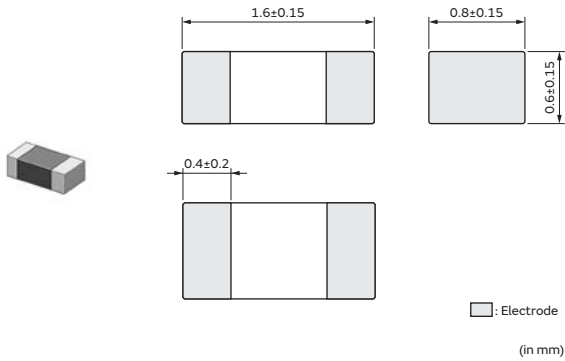

### Packaging

Code	Packaging	Minimum Quantity
D	∅180mm Paper Tape	4000
J	∅330mm Paper Tape	10000
B	Bulk(Bag)	1000

### Equivalent Circuit

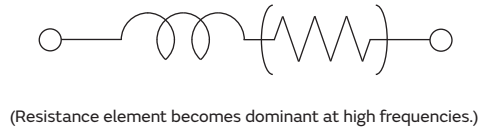

### Rated Value (□: packaging code)

Part Number		Impedance at 100MHz	Rated Current at 85°C	Rated Current at 150°C	DC Resistance (Max.)	Operating Temp. Range
Infotainment	Powertrain/Safety					
—	BLE18PS080BH1□	8.5Ω±25%	5A	10mA	0.004Ω	-55°C to 150°C

### Z-f characteristics

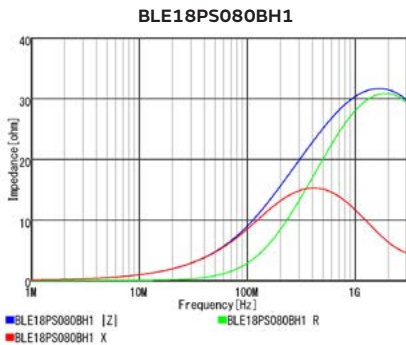

### Derating of Rated Current

In operating temperature exceeding +125°C, derating of current is necessary for BLE18PS\_BH series. Please apply the derating curve shown in chart according to the operating temperature.

Derating of Rated Current

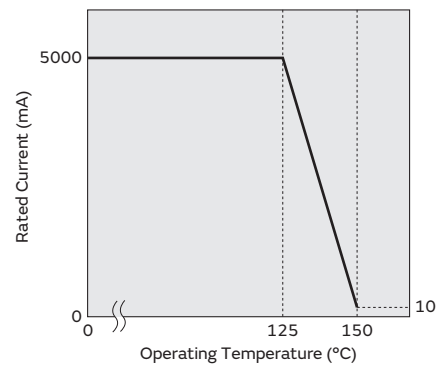



# Chip Ferrite Bead SMD Type

## BLE32PN Series 1210/3225(inch/mm)

### Specifications Sheet (with cautions/mounting/packaging)

Infotainment	<a href="https://www.murata.com/products/productdata/8796199321630/QNFA9113.pdf?1608273989000">https://www.murata.com/products/productdata/8796199321630/QNFA9113.pdf?1608273989000</a>
Powertrain/Safety	<a href="https://www.murata.com/products/productdata/8798913560606/QNFA9133.pdf?1608273989000">https://www.murata.com/products/productdata/8798913560606/QNFA9133.pdf?1608273989000</a>

### Appearance/Dimensions

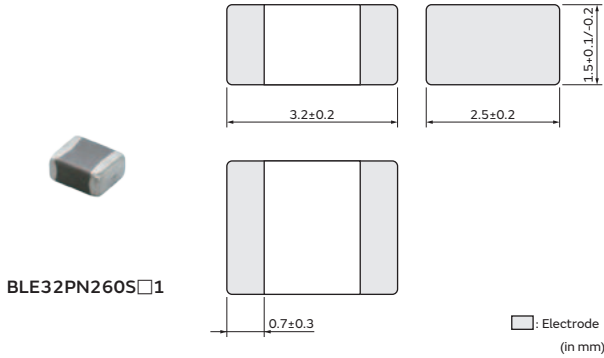

### Packaging

Code	Packaging	Minimum Quantity
K	ø330mm Embossed Tape	7000
L	ø180mm Embossed Tape	1500
B	Bulk(Bag)	1000

### Equivalent Circuit

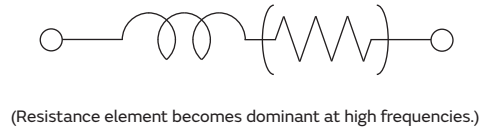

### Appearance/Dimensions

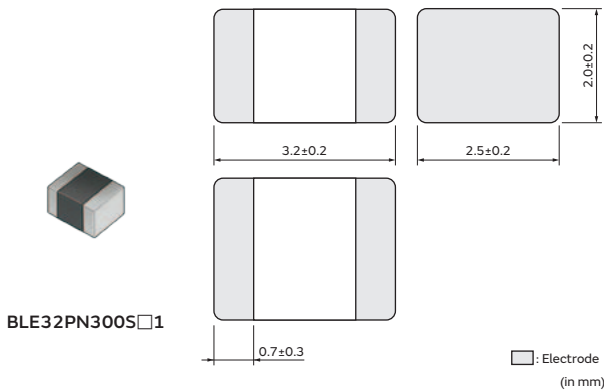

### Packaging

Code	Packaging	Minimum Quantity
K	ø330mm Embossed Tape	7000
L	ø180mm Embossed Tape	1500
B	Bulk(Bag)	1000

### Equivalent Circuit

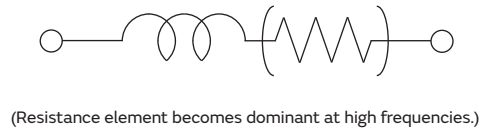

### Rated Value (□: packaging code)

Part Number		Impedance at 100MHz	Rated Current at 85°C	Rated Current at 125°C	DC Resistance (Max.)
Infotainment	Powertrain/Safety				
BLE32PN260SZ1□	BLE32PN260SH1□	26Ω±10Ω	10A	10A	1.6mΩ
BLE32PN300SZ1□	BLE32PN300SH1□	30Ω±10Ω	10A	10A	1.6mΩ

Operating Temp. Range: -55°C to 125°C

### Z-f characteristics

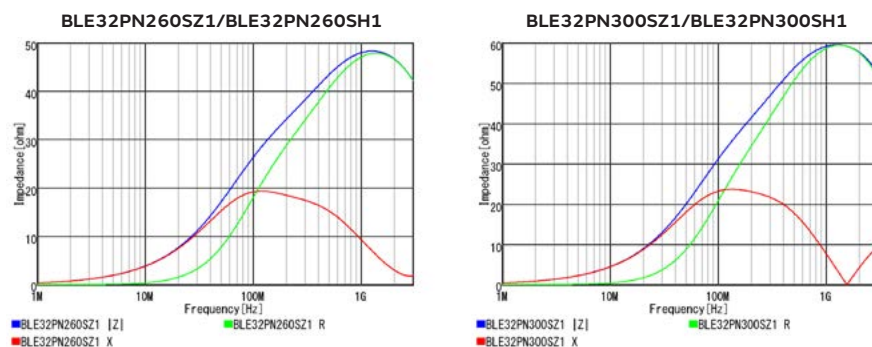

## Chip Ferrite Bead (BL□ Series) ⚠️Caution/Notice

### ⚠️Caution

#### Rating

##### 1. About the Rated Current

Do not use products beyond the rated current as this may create excessive heat and deteriorate the insulation resistance.

##### 2. About the Excessive Surge Current

Excessive surge current (pulse current or rush current) than specified rated current applied to the product may cause a critical failure, such as an open circuit, burnout caused by excessive temperature rise. Please contact us in advance in case of applying the surge current.

#### Soldering and Mounting

##### Self-heating

Please pay special attention when mounting chip ferrite beads BLM□□AX/P/K/S series chip power beads BLE series in close proximity to other products that radiate heat. The heat generated by other products may deteriorate the insulation resistance and cause excessive heat in this component.

#### Fail-safe

Be sure to provide an appropriate fail-safe function on your product to prevent a secondary damage occurrence that may be caused by the abnormal function or the failure of our product.

### Notice

#### Storage and Operating Conditions

##### 1. Operating Environment

Do not use products in the corrodible atmosphere such as acidic gases, alkaline gases, chlorine, sulfur gases, organic gases. (the sea breeze, Cl<sub>2</sub>, H<sub>2</sub>S, NH<sub>3</sub>, SO<sub>2</sub>, NO<sub>2</sub>, etc)  
Do not use products in the environment close to the organic solvent.

##### 2. Storage Period

BLM15E/15H/15G series should be used within 12 months, the other series should be used within 6 months. Solderability should be checked if this period is exceeded.

##### 3. Storage Conditions

- (1) Storage temperature: -10 to +40°C  
Relative humidity: 15 to 85%  
Avoid sudden changes in temperature and humidity.
- (2) Do not store products in a chemical atmosphere such as chlorine gas, acid or sulfide gas.

Continued on the following page. ↗

## Chip Ferrite Bead (BL□ Series) ⚠️Caution/Notice

Continued from the preceding page. ↘

### Notice (Soldering and Mounting)

#### 1. Soldering

Please mount products by flow or reflow soldering except for BLM\_WH1.

#### 2. Mounting on-board with Conductive Glue

BLM\_WH1 is designed for conductive glue mounting method. Please contact us for details.

#### 3. Other

Noise suppression levels resulting from Murata's EMI suppression filters EMIFIL may vary, depending on the circuits and ICs used, type of noise, mounting pattern, mounting location, and other operating conditions. Be sure to check and confirm in advance the noise

suppression effect of each filter, in actual circuits, etc. before applying the filter in a commercial-purpose equipment design.

4. Cracks may occur at the connection of solder (solder fillet portion) due to the difference of the coefficient of thermal expansion from a mounting board when heat stress like heat cycle, etc. are repeatedly given to them. The occurrence of the crack by heat stress may be influenced by the size of a pad, solder volume, heat radiation of mounting board etc., so please pay careful attention to designing when a big change in ambient temperature can be assumed.

### Handling

#### 1. Resin Coating

Using resin for coating/molding products may affect the products performance.

So please pay careful attention in selecting resin.

Prior to use, please make the reliability evaluation with the product mounted in your application set.

#### 2. Handling of a Substrate

After mounting products on a substrate, do not apply any stress to the product caused by bending or twisting to the substrate when cropping the substrate, inserting and removing a connector from the substrate or tightening screw to the substrate.

Excessive mechanical stress may cause cracking in the Product.



#### 3. Mounting Density

Add special attention to radiating heat of products when mounting the inductor near the products with heating. The excessive heat by other products may cause deterioration at joint of this product with substrate.

### Cleaning

Following conditions should be observed when cleaning chip ferrite beads.

- (1) Cleaning temperature: 60°C max. (40°C max. for alcohol type cleaner)

(2) Ultrasonic

Output: 20W/liter max.

Duration: 5 minutes max.

Frequency: 28 to 40kHz

(3) Cleaning agent

The following list of cleaning agents have been tested on the individual components. Evaluation of final assembly should be completed prior to production.

Do not clean BLM18AG□□□WH1 series. Before cleaning, please contact Murata engineering.

- (a) Alcohol cleaning agent

Isopropyl alcohol (IPA)

- (b) Aqueous cleaning agent

Pine Alpha ST-100S

- (4) Ensure that flux residue is completely removed.

Component should be thoroughly dried after aqueous agent has been removed with deionized water.

- (5) BLM□□G type is processed with resin. On rinsing the product, using water for ultrasonic cleaning may affect the resin quality used for the product by water element.

In case of set cleaning conditions, please make sure the reliability according to the cleaning conditions.

For additional cleaning methods, please contact Murata engineering

### About Corrosive Gases

Please refrain from use since contact with environments with corrosive gases (sulfur gas [hydrogen sulfide, sulfur dioxide, etc.], chlorine, ammonia, etc.) or oils (cutting oil, silicone oil, etc.) that have come into contact with the previously stated corrosive gas environment will result in deterioration of product quality or an open from deterioration due to corrosion of product electrode, etc.

We will not bear any responsibility for use under these environments.

## ● Part Numbering

### Chip EMIFIL for Automotive LC Combined

(Part Number) 

NF	L	18	ZT	107	H	1A	3	L
①	②	③	④	⑤	⑥	⑦	⑧	⑨

#### ① Product ID

Product ID	
NF	Chip EMIFIL

#### ② Structure

Code	Structure
L	Multilayer, LC Combined Type
E	Block, LC Combined Type

#### ③ Dimensions (LxW)

Code	Dimensions (LxW)	Size Code (inch)
18	1.6x0.8mm	0603
31	3.2x1.6mm	1206
61	6.8x1.6mm	2706

#### ④ Features

Code	Features	
HT	For Automotive	Powertrain, Safety, T Circuit
ZT		Infotainment, T Circuit

#### ⑤ Cut-off Frequency (NFL Series)

Expressed by three figures. The unit is in hertz (Hz). The first and second figures are significant digits, and the third figure expresses the number of zeros that follow the two figures.

#### ⑥ Capacitance (NFE Series)

Expressed by three figures. The unit is in pico-farad (pF). The first and second figures are significant digits, and the third figure expresses the number of zeros that follow the two figures.

#### ⑥ Characteristics (NFL Series)

Code	Characteristics
H	Cut-off Frequency

#### ⑥ Characteristics (NFE Series)

Code	Capacitance Temperature Characteristics
C	±20%, ±22%
D	+20/-30%, +22/-33%
F	+30/-80%, +22/-82%
R	±15%
U	-750 ±120ppm/ °C
Z	Other

#### ⑦ Rated Voltage

Code	Rated Voltage
1A	10V
1E	25V
2A	100V

#### ⑧ Electrode

Code	Electrode	Series
3	Sn Plating	NFL
9	Others	NFE

#### ⑨ Packaging

Code	Packaging
K	Embossed Taping (ø330mm Reel)
L	Embossed Taping (ø180mm Reel)
B	Bulk
D	Paper Taping (ø180mm Reel)

### Chip EMIFIL for Automotive

(Part Number) 

NF	Z	32	BW	3R6	H	Z	1	0	L
①	②	③	④	⑤	⑥	⑦	⑧	⑨	⑩

#### ① Product ID

Product ID	
NF	Chip EMIFIL

#### ② Structure

Code	Structure
Z	Inductor Type

#### ③ Dimensions (LxW)

Code	Dimensions (LxW)	Size Code (inch)
15	1.0x0.5mm	0402
18	1.6x0.8mm	0603
2M	2.0x1.6mm	0806
32	3.2x2.5mm	1210
5B	5.0x5.0mm	2020

#### ④ Features

Code	Features
SD	For Audio Lines Metal Alloy Type
SM	For Audio Lines Multilayer Type
SF	For Audio Lines Multilayer Type (For FM Band Use)
BW	For LED Lines Wire Wound Type

#### ⑤ Impedance

Expressed by three figures. The unit is in ohm ( $\Omega$ ). The first and second figures are significant digits, and the third figure expresses the number of zeros that follow the two figures.

#### ⑥ Inductance Tolerance

Code	Features
S	For General Use (Sn Plating)
H	For General Use (LF Solder) * <sup>1</sup>
L	For General Use (LF Solder)

\*<sup>1</sup> NFZ32BW\_H□1 only.

#### ⑦ Category

Code	Category	
Z	For Automotive	Infotainment

#### ⑧ Number of Circuits

Code	Number of Circuits
1	1 Circuit

#### ⑨ Specification

Code	Specification
0	Standard Type
1	Low Rdc Type

#### ⑩ Packaging

Code	Packaging
K	Embossed Taping ( $\phi$ 330mm Reel)
L	Embossed Taping ( $\phi$ 180mm Reel)
B	Bulk
D	Paper Taping ( $\phi$ 180mm Reel)

Chip Ferrite Bead  
 Chip EMIFIL  
 Chip Common Mode Choke Coil  
 Block Type EMIFIL  
 Microchip Transformer (Ballun)  
 Inductors for Power Lines  
 Inductors for General Circuits  
 RF Inductors

# Feed Through Chip EMI Filters SMD Type

## NFE31ZT Series 1206/3216(inch/mm)

### Specifications Sheet (with cautions/mounting/packaging)

Infotainment	<a href="https://www.murata.com/products/productdata/8796200009758/QNFE9102.pdf?1561681112000">https://www.murata.com/products/productdata/8796200009758/QNFE9102.pdf?1561681112000</a>
Powertrain/Safety	—

### Appearance/Dimensions

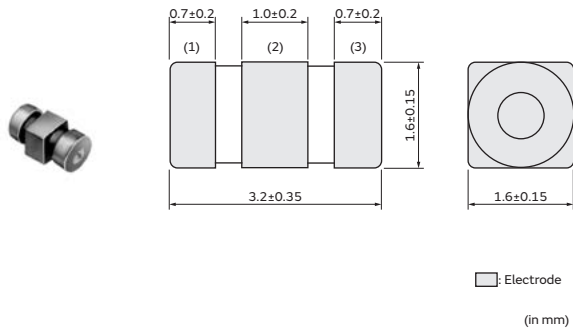

### Packaging

Code	Packaging	Minimum Quantity
L	ø180mm Embossed Tape	2000
K	ø330mm Embossed Tape	8000
B	Bulk(Bag)	500

### Equivalent Circuit

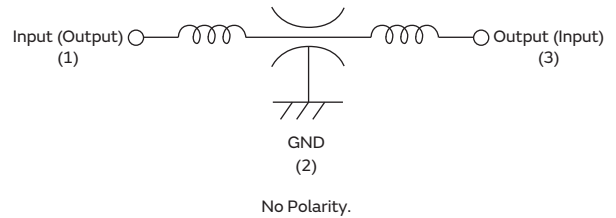

### Rated Value (□: packaging code)

Part Number		Capacitance	Rated Current	Rated Voltage	Insulation Resistance (min.)	Operating Temp. Range
Infotainment	Powertrain/Safety					
NFE31ZT220R1E9□	—	22pF ±30%	6A	25Vdc	1000MΩ	-40°C to +85°C
NFE31ZT470C1E9□	—	47pF 50/-20%	6A	25Vdc	1000MΩ	-40°C to +85°C
NFE31ZT101C1E9□	—	100pF 80/-20%	6A	25Vdc	1000MΩ	-40°C to +85°C
NFE31ZT221D1E9□	—	220pF 50/-20%	6A	25Vdc	1000MΩ	-40°C to +85°C
NFE31ZT471F1E9□	—	470pF 50/-20%	6A	25Vdc	1000MΩ	-40°C to +85°C
NFE31ZT152Z1E9□	—	1500pF 50/-20%	6A	25Vdc	1000MΩ	-40°C to +85°C
NFE31ZT222Z1E9□	—	2200pF ±50%	6A	25Vdc	1000MΩ	-40°C to +85°C

Number of Circuits: 1

### Insertion Loss Characteristics (Main Items)

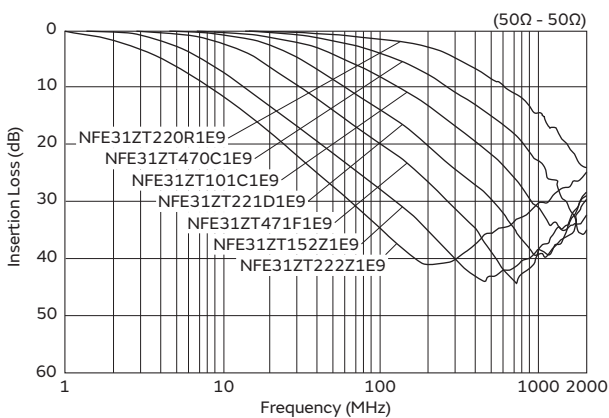

# Feed Through Chip EMI Filters SMD Type

## NFE61HT Series 2706/6816(inch/mm)

### Specifications Sheet (with cautions/mounting/packaging)

Infotainment	—
Powertrain/Safety	<a href="https://www.murata.com/products/productdata/8796200042526/QNFE9101.pdf?1561681112000">https://www.murata.com/products/productdata/8796200042526/QNFE9101.pdf?1561681112000</a>

### Appearance/Dimensions

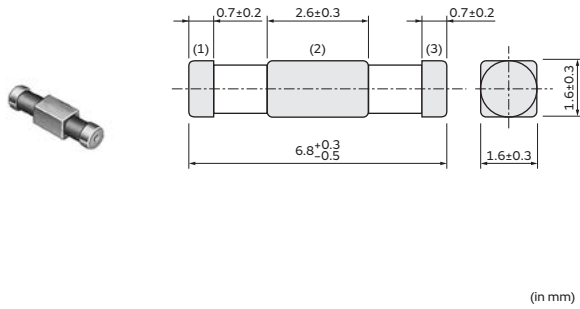

### Packaging

Code	Packaging	Minimum Quantity
L	∅180mm Embossed Tape	2500
K	∅330mm Embossed Tape	8000
B	Bulk(Bag)	500

### Equivalent Circuit

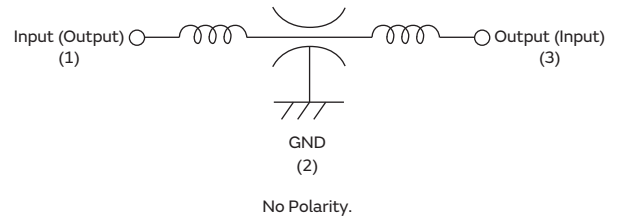

### Rated Value (□: packaging code)

Part Number		Capacitance	Rated Current	Rated Voltage	Insulation Resistance (min.)	Operating Temp. Range
Infotainment	Powertrain/Safety					
—	NFE61HT330U2A9□	33pF ±30%	2A	100Vdc	1000MΩ	-55°C to +125°C
—	NFE61HT680R2A9□	68pF ±30%	2A	100Vdc	1000MΩ	-55°C to +125°C
—	NFE61HT101Z2A9□	100pF ±30%	2A	100Vdc	1000MΩ	-55°C to +125°C
—	NFE61HT181C2A9□	180pF ±30%	2A	100Vdc	1000MΩ	-55°C to +125°C
—	NFE61HT361C2A9□	360pF ±20%	2A	100Vdc	1000MΩ	-55°C to +125°C
—	NFE61HT681D2A9□	680pF ±30%	2A	100Vdc	1000MΩ	-55°C to +125°C
—	NFE61HT102F2A9□	1000pF 80/-20%	2A	100Vdc	1000MΩ	-55°C to +125°C
—	NFE61HT332Z2A9□	3300pF 80/-20%	2A	100Vdc	1000MΩ	-55°C to +125°C

Number of Circuit: 1

### Insertion Loss Characteristics (Main Items)

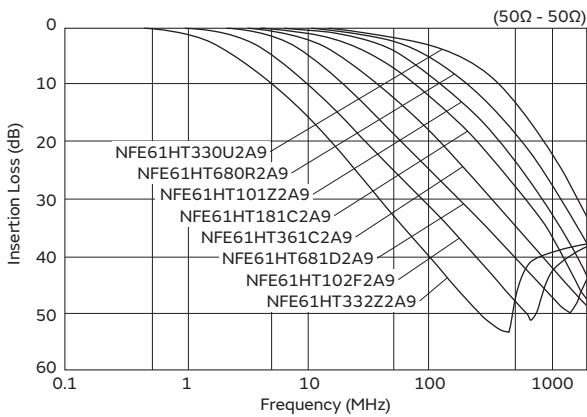



# LC Combined Filters (Multilayer Type) SMD Type

## NFL18ZT Series 0603/1608(inch/mm)

### Specifications Sheet (with cautions/mounting/packaging)

Infotainment	<a href="https://www.murata.com/products/productdata/8796200075294/QNFD9101.pdf?1561681112000">https://www.murata.com/products/productdata/8796200075294/QNFD9101.pdf?1561681112000</a>
Powertrain/Safety	—

### Appearance/Dimensions

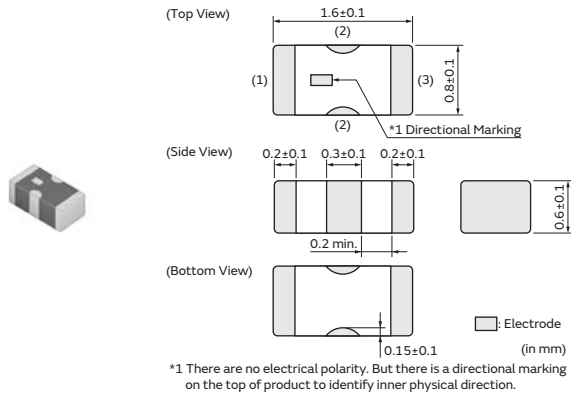

### Packaging

Code	Packaging	Minimum Quantity
D	ø180mm Paper Tape	4000
B	Bulk(Bag)	1000

### Equivalent Circuit

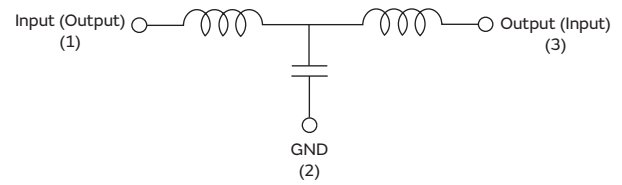

No Polarity.

### Rated Value (□: packaging code)

Part Number		Nominal Cut-off Frequency	Capacitance	Inductance	Rated Current	Rated Voltage	Insulation Resistance (min.)	Withstanding Voltage
Infotainment	Powertrain/Safety							
NFL18ZT506H1A3□	—	50MHz	110pF (Typ.)	350nH (Typ.)	75mA	10Vdc	1000MΩ	30Vdc
NFL18ZT706H1A3□	—	70MHz	70pF (Typ.)	230nH (Typ.)	75mA	10Vdc	1000MΩ	30Vdc
NFL18ZT107H1A3□	—	100MHz	50pF (Typ.)	150nH (Typ.)	75mA	10Vdc	1000MΩ	30Vdc
NFL18ZT207H1A3□	—	200MHz	22pF (Typ.)	110nH (Typ.)	100mA	10Vdc	1000MΩ	30Vdc
NFL18ZT307H1A3□	—	300MHz	16pF (Typ.)	74nH (Typ.)	100mA	10Vdc	1000MΩ	30Vdc
NFL18ZT507H1A3□	—	500MHz	10pF (Typ.)	42nH (Typ.)	100mA	10Vdc	1000MΩ	30Vdc

Number of Circuit: 1 Operating Temp. Range: -55°C to +125°C

### Insertion Loss Characteristics (Main Items)

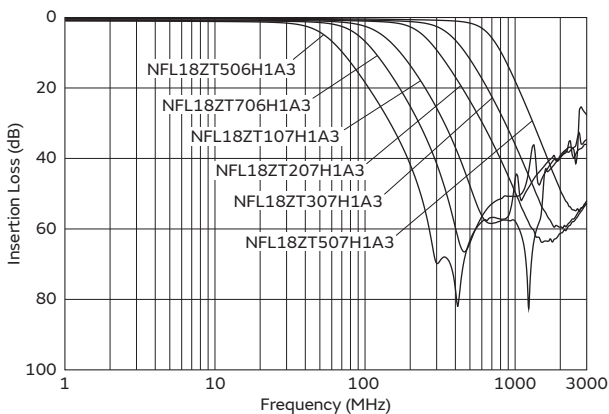

# Chip EMIFIL® SMD Type

## NFZ15SF\_SZ10 Series 0402/1005(inch/mm)

### Specifications Sheet (with cautions/mounting/packaging)

Infotainment	<a href="https://www.murata.com/products/productdata/8805144166430/QNFJ9106.pdf?1565240589000">https://www.murata.com/products/productdata/8805144166430/QNFJ9106.pdf?1565240589000</a>
Powertrain/Safety	—

### Appearance/Dimensions

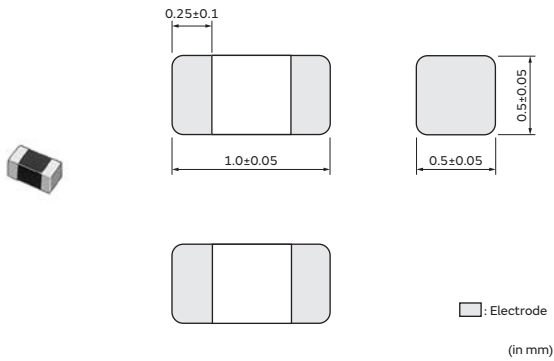

### Packaging

Code	Packaging	Minimum Quantity
D	∅180mm Paper Tape	10000
B	Bulk(Bag)	1000

### Equivalent Circuit

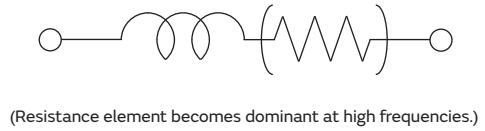

### Rated Value (□: packaging code)

Part Number		Impedance at 100MHz	Rated Current	DC Resistance	DC Resistance (Max.)	Operating Temp. Range
Infotainment	Powertrain/Safety					
NFZ15SF102SZ10□	—	1000Ω±25%	230mA	0.96Ω (Typ.)	1.4Ω	-55°C to 125°C

### Z-f characteristics

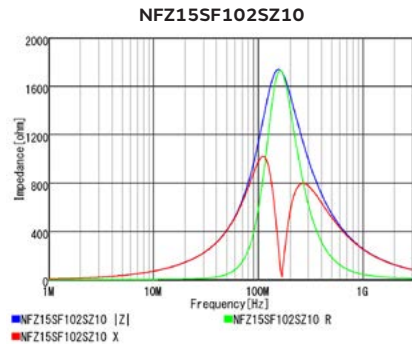

Chip Ferrite Bead

Chip EMIFIL

Chip Common Mode Choke Coil

Block Type EMIFIL

Microchip Transformer (Balun)

Inductors for Power Lines

Inductors for General Circuits

RF Inductors

# Chip EMIFIL® SMD Type

## NFZ18SM\_SZ10 Series 0603/1608(inch/mm)

### Specifications Sheet (with cautions/mounting/packaging)

Infotainment	<a href="https://www.murata.com/products/productdata/8797899063326/QNFJ9104.pdf?1513313573000">https://www.murata.com/products/productdata/8797899063326/QNFJ9104.pdf?1513313573000</a>
Powertrain/Safety	—

### Appearance/Dimensions

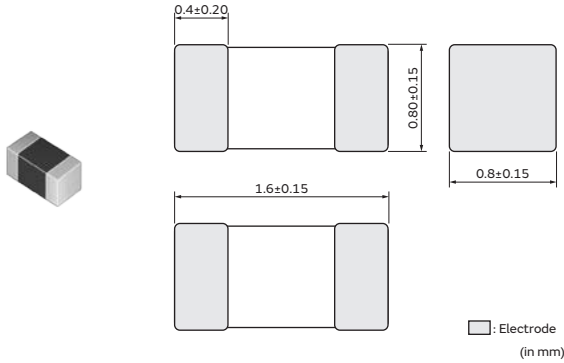

### Packaging

Code	Packaging	Minimum Quantity
D	ø180mm Paper Tape	4000
B	Bulk(Bag)	1000

### Equivalent Circuit



(Resistance element becomes dominant at high frequencies.)

### Rated Value (□: packaging code)

Part Number		Impedance at 100MHz	Rated Current	DC Resistance	DC Resistance (Max.)
Infotainment	Powertrain/Safety				
NFZ18SM121SZ10□	—	120Ω±25%	1.25A	0.11Ω (Typ.)	0.14Ω
NFZ18SM251SZ10□	—	250Ω±25%	1.1A	0.15Ω (Typ.)	0.19Ω
NFZ18SM501SZ10□	—	500Ω±25%	950mA	0.20Ω (Typ.)	0.25Ω
NFZ18SM701SZ10□	—	700Ω±25%	800mA	0.23Ω (Typ.)	0.29Ω

Operating Temp. Range: -55°C to 125°C

### Z-f characteristics

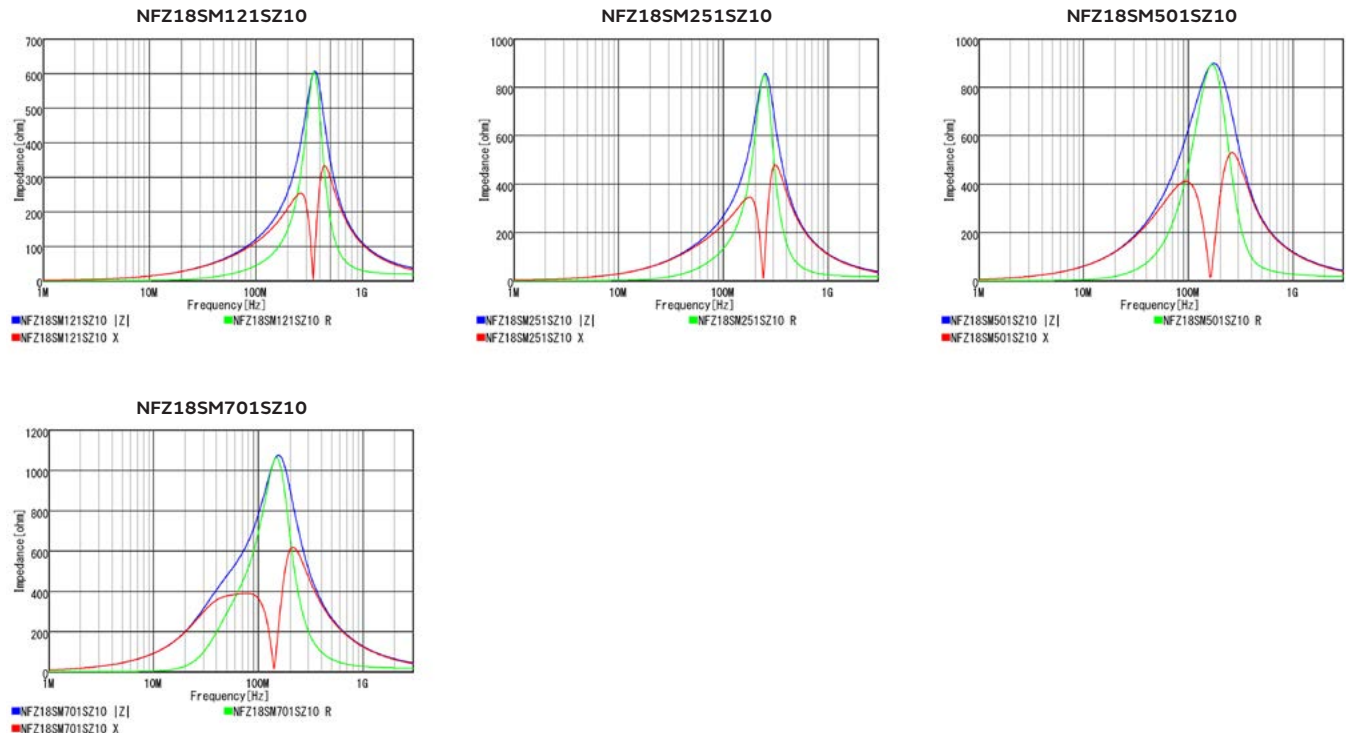

Continued on the following page. ↗

Continued from the preceding page. ↘

## Derating of Rated Current

In operating temperature exceeding +85°C, derating of current is necessary for NFZ18SM series.  
Please apply the derating curve shown in chart according to the operating temperature.

Derating of Rated Current

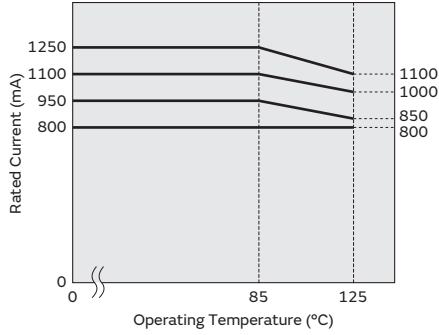

# Chip EMIFIL® SMD Type

# NFZ2MSD\_SZ10 Series 0806/2016(inch/mm)

## Specifications Sheet (with cautions/mounting/packaging)

Infotainment	<a href="https://www.murata.com/products/productdata/8804339089438/QTEA9103.pdf?1559881523000">https://www.murata.com/products/productdata/8804339089438/QTEA9103.pdf?1559881523000</a>
Powertrain/Safety	—

### Appearance/Dimensions

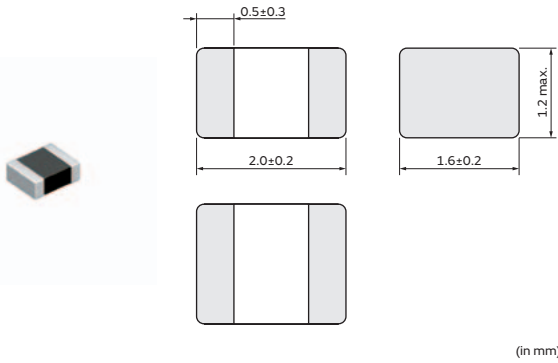

### Packaging

Code	Packaging	Minimum Quantity
L	ø180mm Embossed Tape	3000

### Equivalent Circuit



(Resistance element becomes dominant at high frequencies.)

### Rated Value (□: packaging code)

Part Number		Impedance at 10MHz	Rated Current	DC Resistance
Infotainment	Powertrain/Safety			
NFZ2MSD101SZ10□	—	9Ω±30%	5.2A	18mΩ max.
NFZ2MSD181SZ10□	—	15Ω±30%	4A	22mΩ max.
NFZ2MSD301SZ10□	—	21Ω±30%	3.8A	26mΩ max.
NFZ2MSD501SZ10□	—	29Ω±30%	3.2A	32mΩ max.
NFZ2MSD102SZ10□	—	46Ω±30%	2.5A	46mΩ max.

Operating Temp. Range: -40°C to 85°C

Operating Temp. Range self-temp. rise included: -40°C to 125°C

### Z-f characteristics

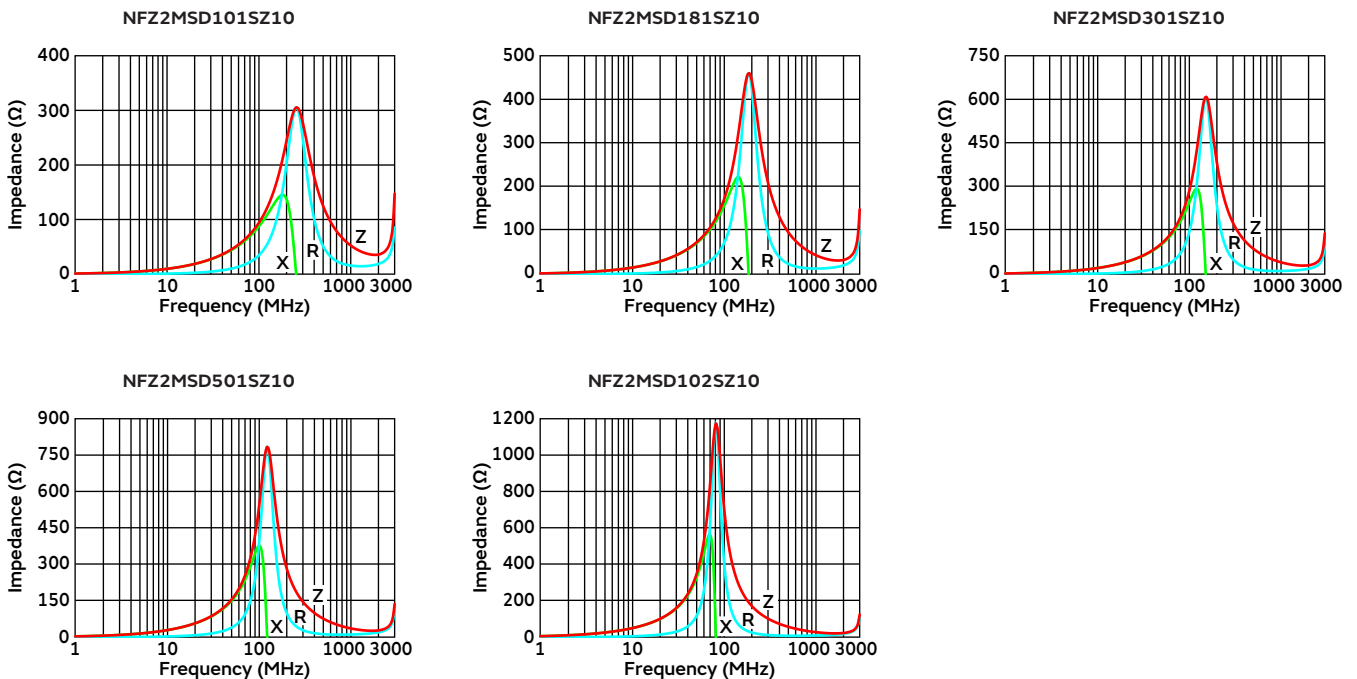

Continued on the following page. ↗

Continued from the preceding page. ↘

## Derating of Rated Current

Max. current (DC, AC) as function of product temperature (derating curve).

Derating of Rated Current

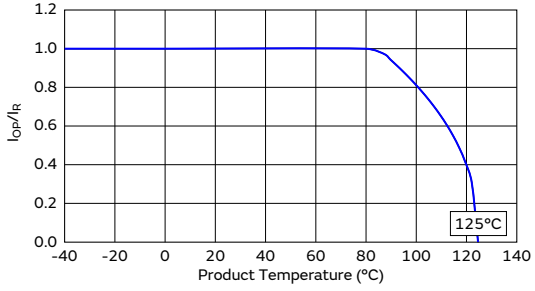

Chip Ferrite Bead

Chip EMIFIL

Chip Common Mode Choke Coil

Block Type EMIFIL

Microchip Transformer (Balun)

Inductors for Power Lines

Inductors for General Circuits

RF Inductors

# Chip EMIFIL® SMD Type

## NFZ32BW\_HZ10 Series 1210/3225(inch/mm)

### Specifications Sheet (with cautions/mounting/packaging)

Infotainment	<a href="https://www.murata.com/products/productdata/8796200534046/QNFJ9101.pdf?1581378346000">https://www.murata.com/products/productdata/8796200534046/QNFJ9101.pdf?1581378346000</a>
Powertrain/Safety	—

### Appearance/Dimensions

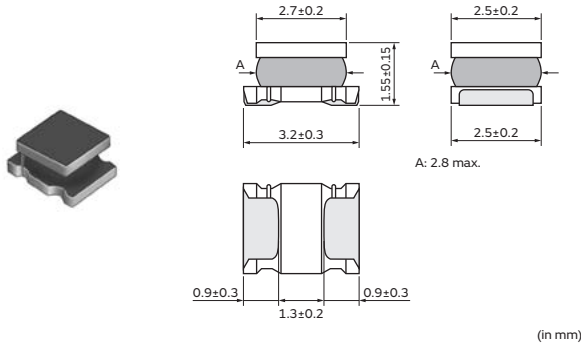

### Packaging

Code	Packaging	Minimum Quantity
K	ø330mm Embossed Tape	7500
L	ø180mm Embossed Tape	2000

### Equivalent Circuit



(Resistance element becomes dominant at high frequencies.)

### Rated Value (□: packaging code)

Part Number		Impedance at 1MHz	Rated Current	DC Resistance
Infotainment	Powertrain/Safety			
NFZ32BW3R6HZ10□	—	3.6Ω±30%	2.55A	0.03Ω±20%
NFZ32BW7R4HZ10□	—	7.4Ω±30%	2.05A	0.045Ω±20%
NFZ32BW9R0HZ10□	—	9Ω±30%	1.75A	0.057Ω±20%
NFZ32BW150HZ10□	—	15Ω±30%	1.6A	0.076Ω±20%
NFZ32BW210HZ10□	—	21Ω±30%	1.2A	0.12Ω±20%
NFZ32BW320HZ10□	—	32Ω±30%	1A	0.18Ω±20%
NFZ32BW420HZ10□	—	42Ω±30%	850mA	0.24Ω±20%
NFZ32BW700HZ10□	—	70Ω±30%	700mA	0.38Ω±20%
NFZ32BW111HZ10□	—	110Ω±30%	520mA	0.57Ω±20%
NFZ32BW151HZ10□	—	150Ω±30%	450mA	0.81Ω±20%
NFZ32BW221HZ10□	—	220Ω±30%	390mA	1.15Ω±20%
NFZ32BW291HZ10□	—	290Ω±30%	310mA	1.78Ω±20%
NFZ32BW451HZ10□	—	450Ω±30%	275mA	2.28Ω±20%
NFZ32BW621HZ10□	—	620Ω±30%	250mA	2.7Ω±20%
NFZ32BW881HZ10□	—	880Ω±30%	200mA	4.38Ω±20%

Operating Temp. Range: -40°C to 105°C

Operating Temp. Range self-temp. rise included: -40°C to 125°C

### Z-f characteristics

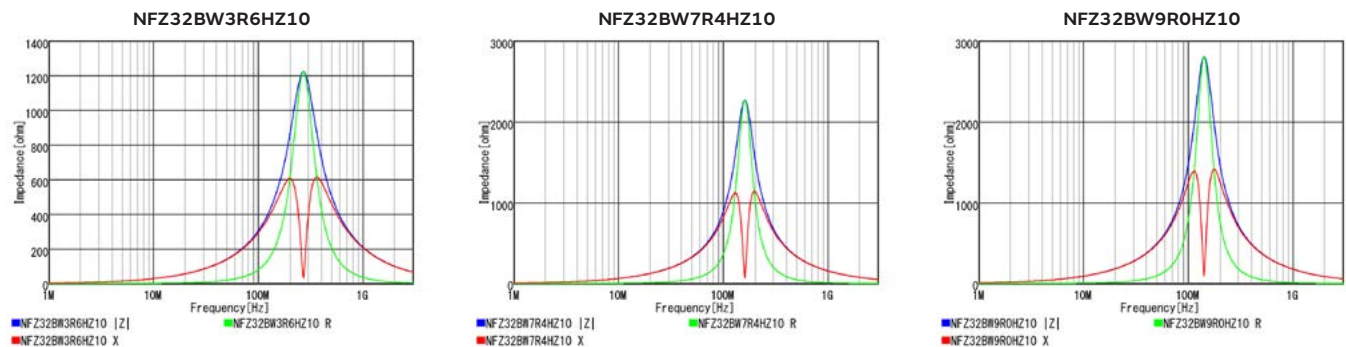

Continued on the following page. ↗

Chip Ferrite Bead  
 Chip EMIFIL  
 Chip Common Mode Choke Coil  
 Block Type EMIFIL  
 Microchip Transformer (Ballun)  
 Inductors for Power Lines  
 Inductors for General Circuits  
 RF Inductors



Continued from the preceding page. ↘

## Z-f characteristics

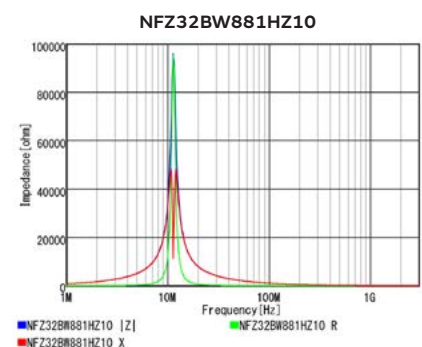
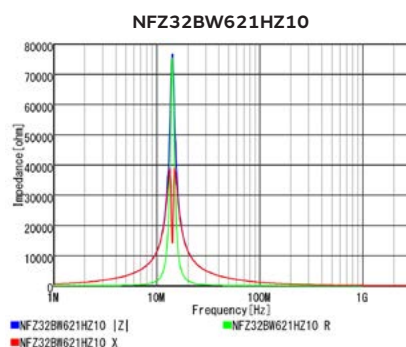
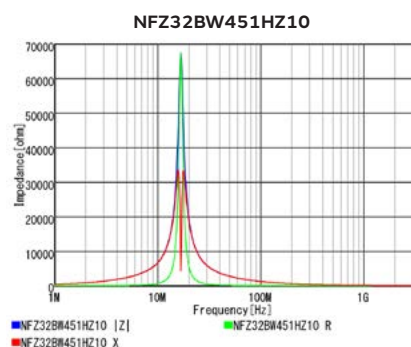
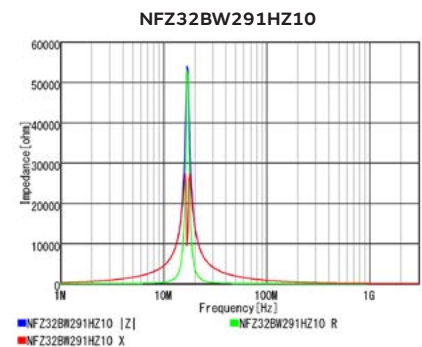
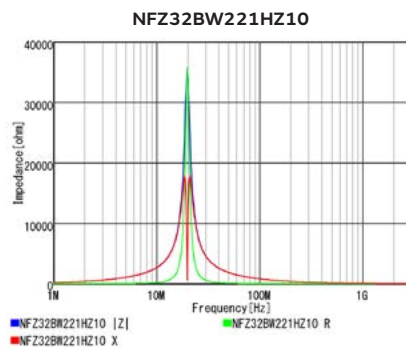
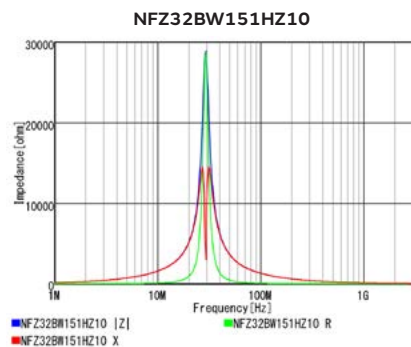
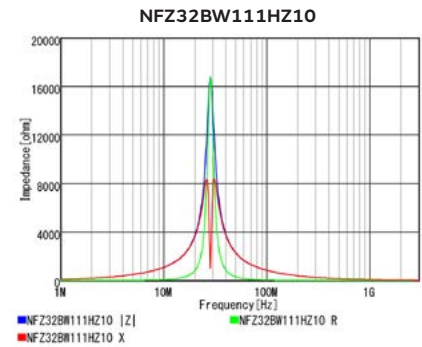
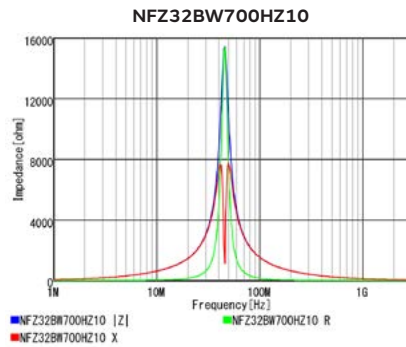
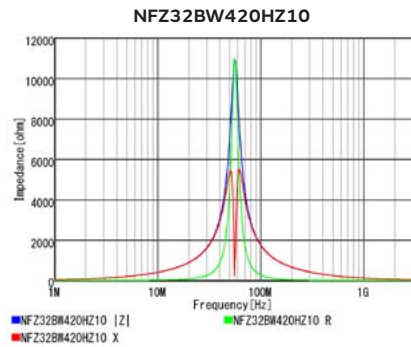
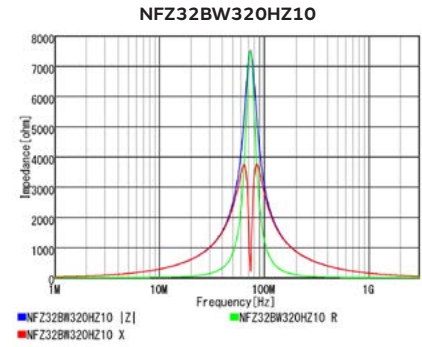
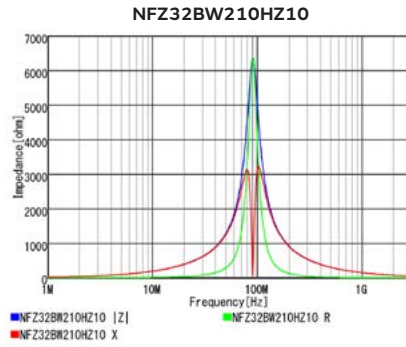
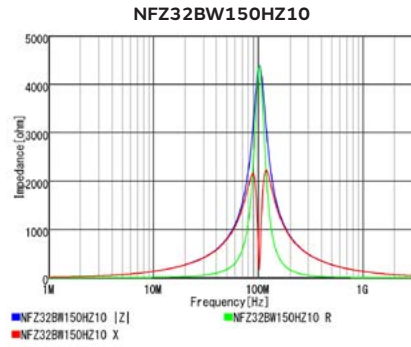

Continued on the following page. ↗

Chip Ferrite Bead

Chip EMI FIL

Chip Common Mode Choke Coil

Block Type EMI FIL

Microchip Transformer (Balun)

Inductors for Power Lines

Inductors for General Circuits

RF Inductors

Continued from the preceding page. ↘

## Derating of Rated Current

In operating temperature exceeding +85°C, derating of current is necessary for NFZ32BW\_H□10 series. Please apply the derating curve shown in chart according to the operating temperature.

Derating of Rated Current

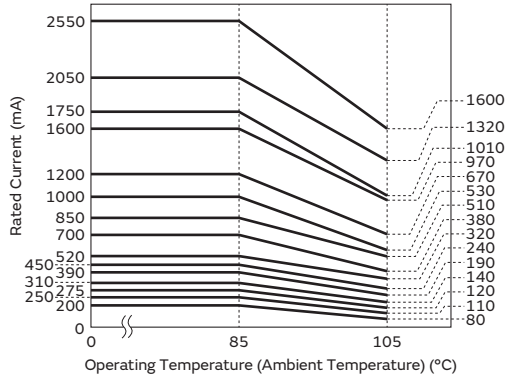

Chip Ferrite Bead

Chip EMI/FIL

Chip Common Mode Choke Coil

Block Type EMI/FIL

Microchip Transformer (Balun)

Inductors for Power Lines

Inductors for General Circuits

RF Inductors

# Chip EMIFIL<sup>®</sup> SMD Type

# NFZ32BW\_HZ11 Series 1210/3225(inch/mm)

## Specifications Sheet (with cautions/mounting/packaging)

Infotainment	<a href="https://www.murata.com/products/productdata/8796200566814/QNFJ9102.pdf?1581378346000">https://www.murata.com/products/productdata/8796200566814/QNFJ9102.pdf?1581378346000</a>
Powertrain/Safety	—

### Appearance/Dimensions

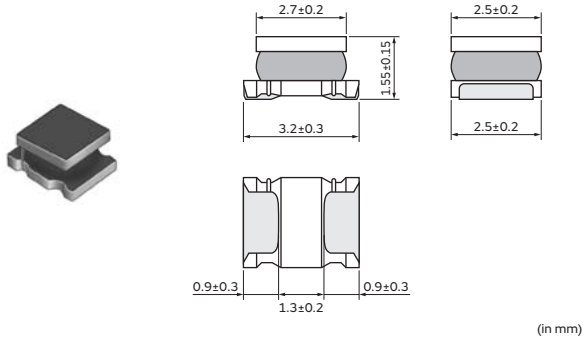

### Packaging

Code	Packaging	Minimum Quantity
K	ø330mm Embossed Tape	7500
L	ø180mm Embossed Tape	2000

### Equivalent Circuit



(Resistance element becomes dominant at high frequencies.)

### Rated Value (□: packaging code)

Part Number		Impedance at 1MHz	Rated Current	DC Resistance
Infotainment	Powertrain/Safety			
NFZ32BW3R3HZ11□	—	3.3Ω±30%	2.9A	0.024Ω±20%
NFZ32BW6R8HZ11□	—	6.8Ω±30%	2.5A	0.036Ω±20%
NFZ32BW8R4HZ11□	—	8.4Ω±30%	2.4A	0.048Ω±20%
NFZ32BW9R8HZ11□	—	9.8Ω±30%	2.1A	0.053Ω±20%
NFZ32BW120HZ11□	—	12Ω±30%	1.85A	0.064Ω±20%
NFZ32BW190HZ11□	—	19Ω±30%	1.8A	0.089Ω±20%
NFZ32BW210HZ11□	—	21Ω±30%	1.55A	0.100Ω±20%
NFZ32BW310HZ11□	—	31Ω±30%	1.2A	0.155Ω±20%
NFZ32BW520HZ11□	—	52Ω±30%	1.1A	0.220Ω±20%
NFZ32BW650HZ11□	—	65Ω±30%	900mA	0.295Ω±20%
NFZ32BW101HZ11□	—	100Ω±30%	900mA	0.475Ω±20%
NFZ32BW151HZ11□	—	150Ω±30%	700mA	0.685Ω±20%

Operating Temp. Range: -40°C to 105°C

Operating Temp. Range self-temp. rise included: -40°C to 125°C

### Z-f characteristics

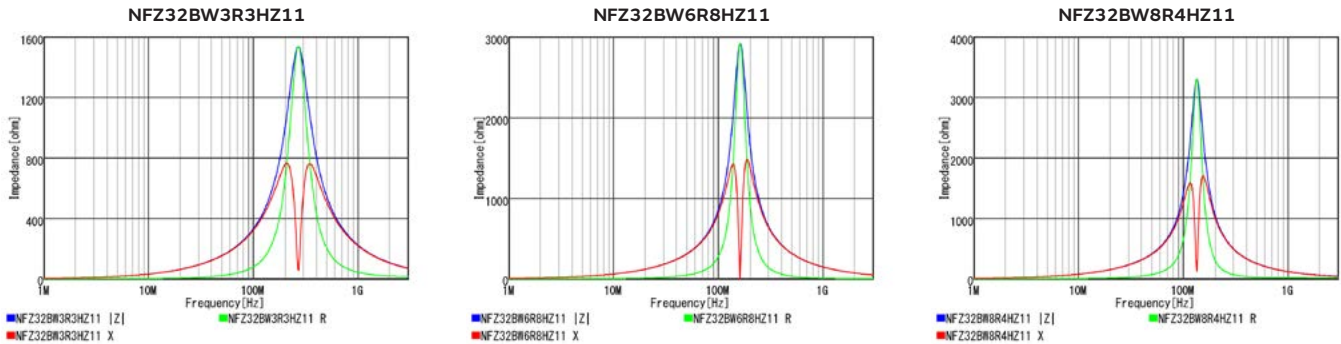

Continued on the following page. ↗

Continued from the preceding page. ↘

## Z-f characteristics

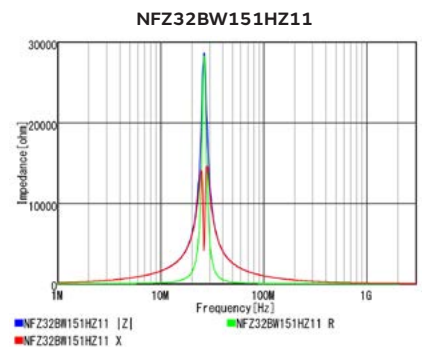
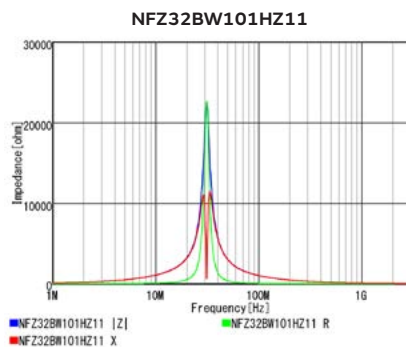
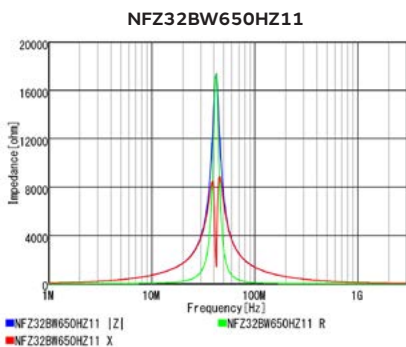
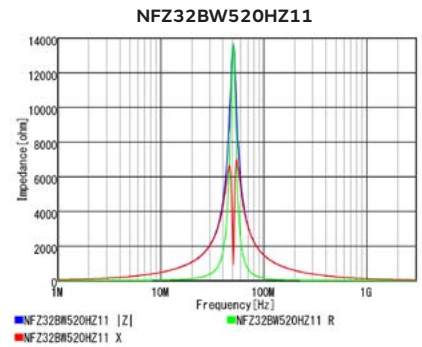
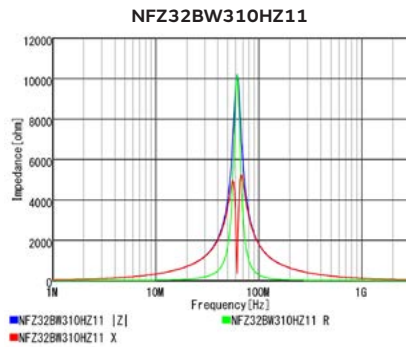
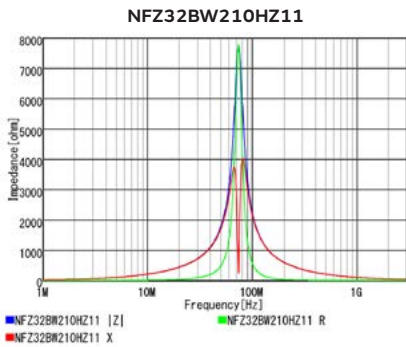
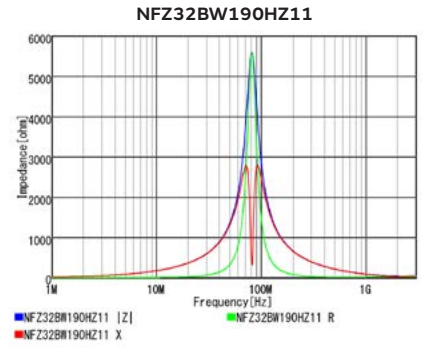
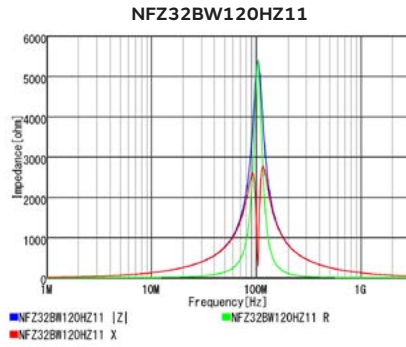
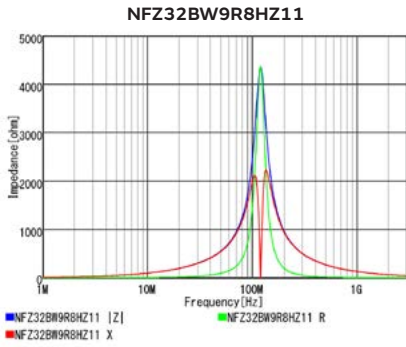

## Derating of Rated Current

In operating temperature exceeding +85°C, derating of current is necessary for NFZ32BW\_H□11 series. Please apply the derating curve shown in chart according to the operating temperature.

Derating of Rated Current

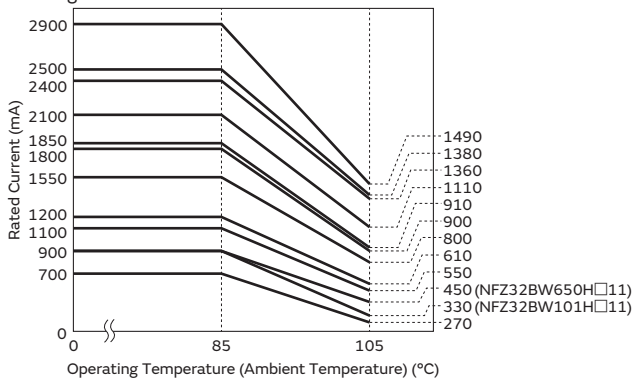

# Chip EMIFIL® SMD Type

# NFZ5BBW\_LZ10 Series 2020/5050(inch/mm)

## Specifications Sheet (with cautions/mounting/packaging)

Infotainment	<a href="https://www.murata.com/products/productdata/8796202336286/QNFJ9103.pdf?1581378347000">https://www.murata.com/products/productdata/8796202336286/QNFJ9103.pdf?1581378347000</a>
Powertrain/Safety	—

### Appearance/Dimensions

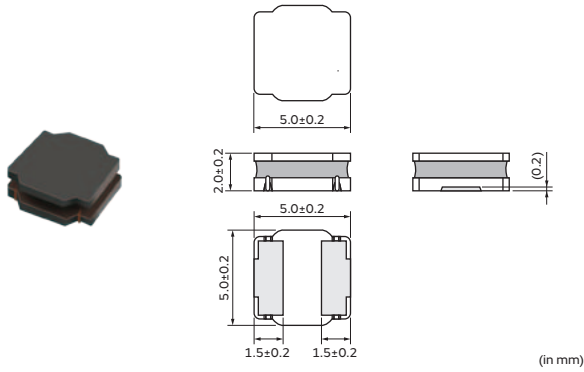

### Packaging

Code	Packaging	Minimum Quantity
K	ø330mm Embossed Tape	3000
L	ø180mm Embossed Tape	500

### Equivalent Circuit

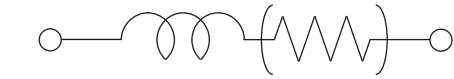

(Resistance element becomes dominant at high frequencies.)

### Rated Value (□: packaging code)

Part Number		Impedance at 1MHz	Rated Current	DC Resistance
Infotainment	Powertrain/Safety			
NFZ5BBW2R9LZ10□	—	2.9Ω±30%	4A	0.012Ω±20%
NFZ5BBW4R5LZ10□	—	4.5Ω±30%	3.4A	0.015Ω±20%
NFZ5BBW6R7LZ10□	—	6.7Ω±30%	3.1A	0.019Ω±20%
NFZ5BBW7R6LZ10□	—	7.6Ω±30%	3.1A	0.019Ω±20%
NFZ5BBW100LZ10□	—	10Ω±30%	3A	0.024Ω±20%
NFZ5BBW140LZ10□	—	14Ω±30%	2.6A	0.030Ω±20%
NFZ5BBW170LZ10□	—	17Ω±30%	2.5A	0.035Ω±20%
NFZ5BBW220LZ10□	—	22Ω±30%	2.3A	0.044Ω±20%
NFZ5BBW310LZ10□	—	31Ω±30%	2A	0.058Ω±20%
NFZ5BBW450LZ10□	—	45Ω±30%	1.65A	0.083Ω±20%
NFZ5BBW520LZ10□	—	52Ω±30%	1.61A	0.100Ω±20%
NFZ5BBW610LZ10□	—	61Ω±30%	1.6A	0.106Ω±20%
NFZ5BBW970LZ10□	—	97Ω±30%	1.2A	0.187Ω±20%
NFZ5BBW141LZ10□	—	140Ω±30%	1.05A	0.259Ω±20%

Operating Temp. Range: -40°C to 105°C

Operating Temp. Range self-temp. rise included: -40°C to 125°C

### Z-f characteristics

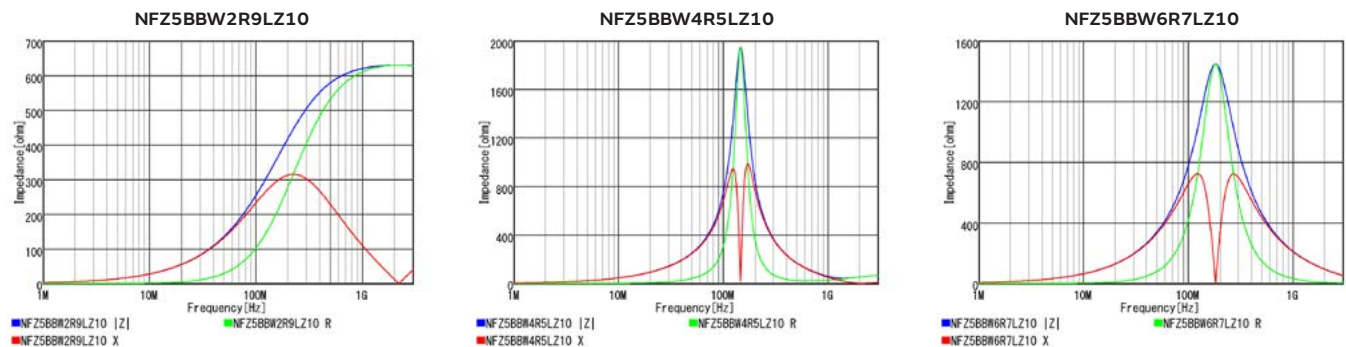

Continued on the following page. ↗

Continued from the preceding page. ↘

## Z-f characteristics

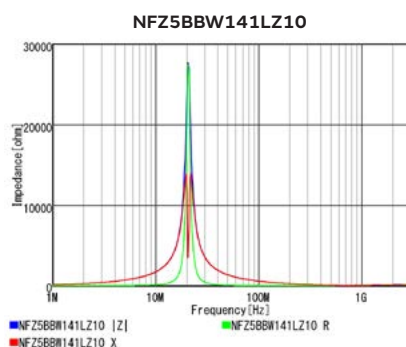
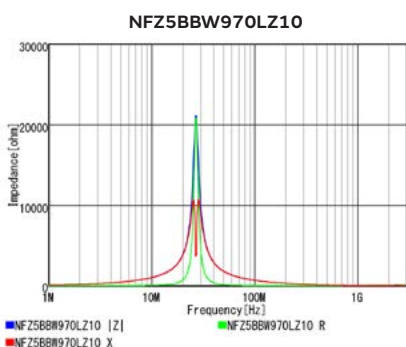
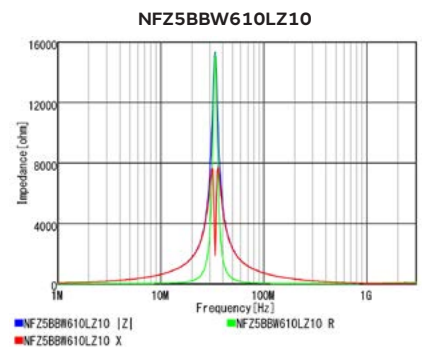
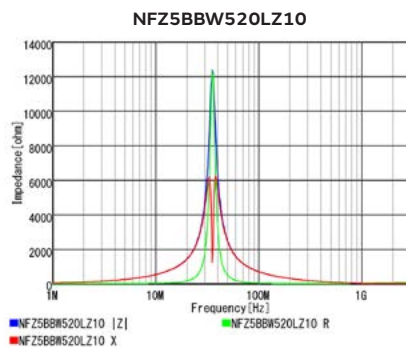
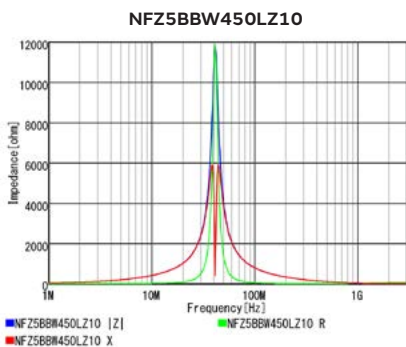
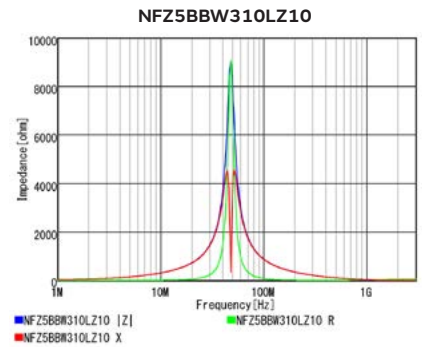
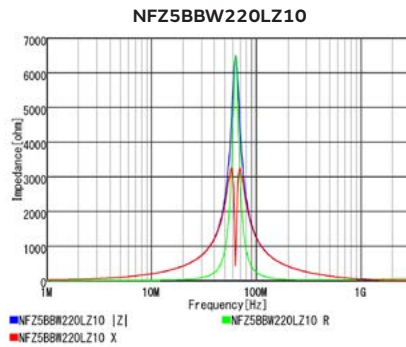
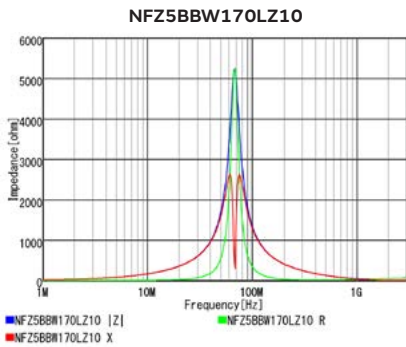
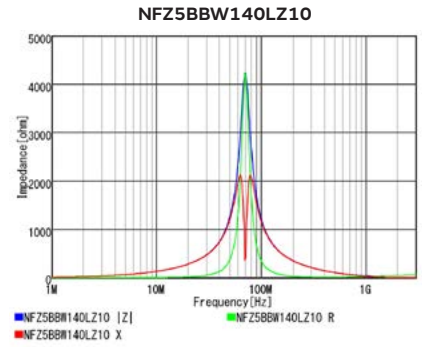
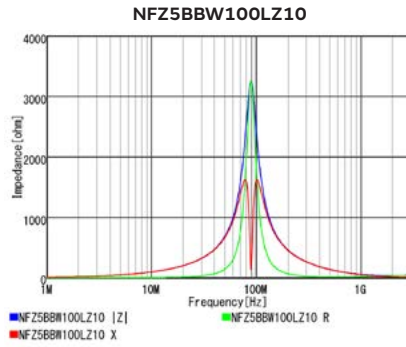
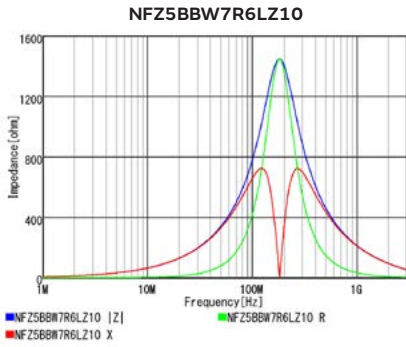

Continued on the following page. ↗

Chip Ferrite Bead

Chip EMIFIL

Chip Common Mode Choke Coil

Block Type EMIFIL

Microchip Transformer (Balun)

Inductors for Power Lines

Inductors for General Circuits

RF Inductors



Continued from the preceding page. ↘

## Derating of Rated Current

In operating temperature exceeding +85°C, derating of current is necessary for NFZ5BBW\_L□10 series. Please apply the derating curve shown in chart according to the operating temperature.

Derating of Rated Current

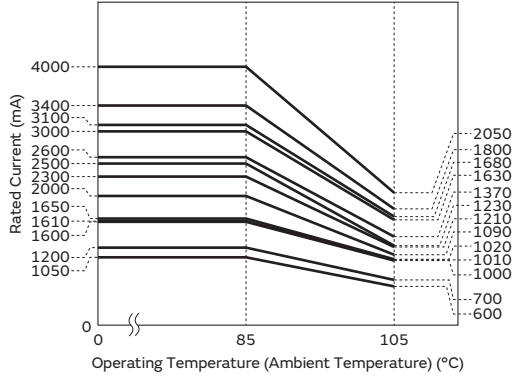



# Chip EMIFIL® SMD Type

## BLF03JD Series 0201/0603(inch/mm)

### Specifications Sheet (with cautions/mounting/packaging)

Infotainment	<a href="https://www.murata.com/products/productdata/8800911130654/QNFA9141.pdf?1513310940000">https://www.murata.com/products/productdata/8800911130654/QNFA9141.pdf?1513310940000</a>
Powertrain/Safety	—

### Appearance/Dimensions

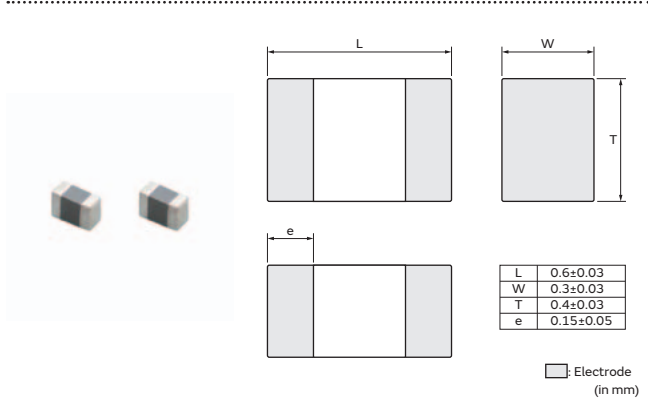

### Packaging

Code	Packaging	Minimum Quantity
D	ø180mm Paper Tape	15000
B	Bulk(Bag)	1000

### Equivalent Circuit

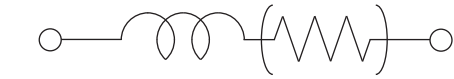

(Resistance element becomes dominant at high frequencies.)

### Rated Value (□: packaging code)

Part Number		Impedance at 700MHz	Rated Current at 85°C	Rated Current at 125°C	DC Resistance (Max.)
Infotainment	Powertrain/Safety				
BLF03JD421GZE□	—	420Ω±40%	480mA	370mA	0.28Ω

Operating Temp. Range: -55°C to 125°C

### Z-f characteristics

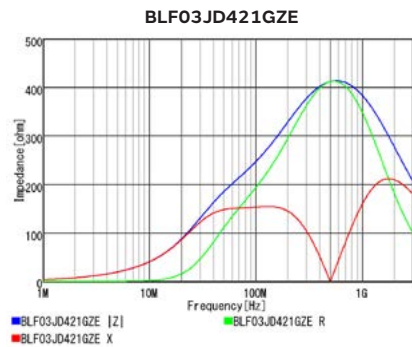

### Derating of Rated Current

In operating temperature exceeding +85°C, derating of current is necessary for this series. Please apply the derating curve shown in chart according to the operating temperature.

#### Derating of Rated Current

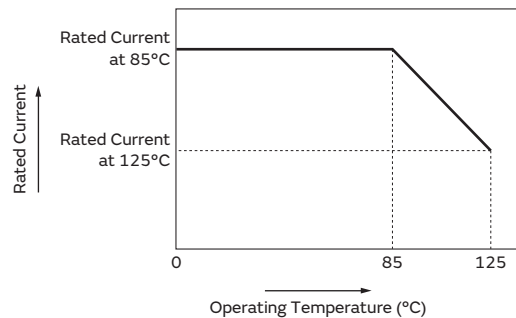

## Chip EMIFIL (NF□ Series) ⚠️Caution/Notice

### ⚠️Caution

#### Rating

##### 1. About the Rated Current

Do not use products beyond the rated current and rated voltage as this may create excessive heat and deteriorate the insulation resistance.

##### 2. About the Excessive Surge Current (NFZ Series)

Excessive surge current (pulse current or rush current) than specified rated current applied to the product may cause a critical failure, such as an open circuit, burnout caused by excessive temperature rise. Please contact us in advance in case of applying the surge current.

#### Soldering and Mounting

Be sure to provide an appropriate fail-safe function on your product to prevent a second damage that may be caused by the abnormal function or the failure our product.

### Notice

#### Storage and Operating Condition

##### 1. Operating Environment

Do not use products in the corrodible atmosphere such as acidic gases, alkaline gases, chlorine, sulfur gases, organic gases. (the sea breeze, Cl<sub>2</sub>, H<sub>2</sub>S, NH<sub>3</sub>, SO<sub>2</sub>, NO<sub>2</sub>, etc)  
Do not use products in the environment close to the organic solvent.

##### 2. Storage Period

The NF series should be used within 12 months.  
Products to be used after this period should be checked for solderability or bondability with glue.

##### 3. Storage Conditions

- (1) Storage temperature: -10 to +40°C  
Relative humidity: 15 to 85%  
Avoid sudden changes in temperature and humidity.
- (2) Do not store products in a chemical atmosphere such as chlorine gas, acid or sulfide gas.

#### Notice (Soldering and Mounting)

##### 1. Soldering

Reliability decreases with improper soldering methods.  
Please solder by the standard soldering conditions shown in mounting information.

##### 2. Other

Noise suppression levels resulting from Murata's EMI suppression filters EMIFIL may vary, depending on the

circuits and ICs used, type of noise, mounting pattern, mounting location, and other operating conditions. Be sure to check and confirm in advance the noise suppression effect of each filter, in actual circuits, etc. before applying the filter in a commercial-purpose equipment design.

Continued on the following page. ↗

## Chip EMIFIL (NF□ Series) ⚠️Caution/Notice

Continued from the preceding page. ↘

### Handling

#### 1. Resin Coating (Except for NFZ Series)

Using resin for coating/molding products may affect the products performance.

So please pay careful attention in selecting resin.

Prior to use, please make the reliability evaluation with the product mounted in your application set.

#### Resin Coating (NFZ\_W Series)

To prevent breaking the wire, avoid touching with sharp material, such as tweezers or other material such as bristles of cleaning brush, to the wire wound portion of this product. To prevent breaking the core, avoid applying excessive mechanical shock to products mounted on the board. An open circuit issue may occur by mechanical stress caused by the resin, amount/cured shape of resin, or operating condition etc. Some resins containing impurities or chloride may possibly.

#### 2. Handling of a Substrate

After mounting products on a substrate, do not apply any stress to the product caused by bending or twisting to the substrate when cropping the substrate, inserting and removing a connector from the substrate or tightening screw to the substrate.

Excessive mechanical stress may cause cracking in the Product.

Bending

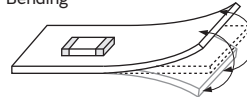

Twisting

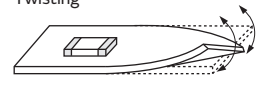

### Cleaning

Following conditions should be observed when cleaning chip EMI filter.

- (1) Cleaning temperature: 60°C max. (40°C max. for alcohol type cleaner)
- (2) Ultrasonic  
Output: 20W/liter max.  
Duration: 5 minutes max.  
Frequency: 28 to 40kHz  
Care should be taken not to cause resonance of the PCB and mounted products.
- (3) Cleaning agent  
The following list of cleaning agents have been tested on the individual components. Evaluation of final assembly should be completed prior to production.

(a) Alcohol cleaning agent  
Isopropyl alcohol (IPA)

(b) Aqueous cleaning agent  
Pine Alpha ST-100S

- (4) Ensure that flux residue is completely removed.  
Component should be thoroughly dried after aqueous agent has been removed with deionized water.  
Failure and degradation of a product are caused by the cleaning method. When you clean in conditions that are not in mounting information, please contact Murata engineering.

### About Corrosive Gases

Please refrain from use since contact with environments with corrosive gases (sulfur gas [hydrogen sulfide, sulfur dioxide, etc.], chlorine, ammonia, etc.) or oils (cutting oil, silicone oil, etc.) that have come into contact with the previously stated corrosive gas environment will result in deterioration of product quality or an open from deterioration due to corrosion of product electrode, etc. We will not bear any responsibility for use under these environments.

## ● Part Numbering

### Chip Common Mode Choke Coil for Automotive

(Part Number) 

DL	W	43	S	H	101	X	K	2	L
①	②	③	④	⑤	⑥	⑦	⑧	⑨	⑩

#### ① Product ID

Product ID	
DL	Chip Common Mode Choke Coils

#### ② Structure

Code	Structure
W	Wire Wound Type

#### ③ Dimensions (LxW)

Code	Dimensions (LxW)	Size Code (inch)
21	2.0x1.2mm	0805
31	3.2x1.6mm	1206
32	3.2x2.5mm	1210
43	4.5x3.2mm	1812
44	4.0x4.0mm	1515
5A	5.0x3.6mm	2014
5B	5.0x5.0mm	2020

#### ④ Features (1)

Code	Type
S	Magnetically Shielded One Circuit Type
T	One Circuit Low Profile Type
M	Magnetically Shielded One Circuit Type (Transfer mode conversion characteristics improved)
U	Non-magnetic One Circuit Type
P	For Power Lines (500mA min)

#### ⑤ Category

Code	Category	
Z	For Automotive	Infotainment
H		Powertrain, Safety

#### ⑥ Impedance

Typical impedance at 100MHz is expressed by three figures. The unit is in ohm ( $\Omega$ ). The first and second figures are significant digits, and the third figure expresses the number of zeros that follow the two figures.

#### ⑥ Inductance (DLW43SH)

Expressed by three figures. The unit is micro-henry ( $\mu$ H). The first and second figures are significant digits, and the third figure expresses the number of zeros which follow the two figures.

#### ⑦ Circuit

Code	Circuit
S	Expressed by a letter.
M	
H	
T	
X	
Y	

#### ⑧ Features (2)

Code	Features
K	Expressed by a letter.
P	
T	
F	
Q	
A	

#### ⑨ Number of Signal Lines

Code	Number of Signal Lines
2	Two Lines

#### ⑩ Packaging

Code	Packaging
K	Embossed Taping ( $\phi$ 330mm Reel)
L	Embossed Taping ( $\phi$ 180mm Reel)
B	Bulk

### Chip Common Mode Choke Coil for Automotive

(Part Number) 

DL	M	11	S	N	900	H	Z	2	L
1	2	3	4	5	6	7	8	9	10

**1** Product ID

Product ID	
DL	Chip Common Mode Choke Coils

**2** Structure

Code	Structure
M	Multilayer Type

**3** Dimensions (LxW)

Code	Dimensions (LxW)	Size Code (inch)
OQ	0.65x0.5mm	025020
ON	0.85x0.65mm	03025
11	1.25x1.0mm	0504

**4** Features (1)

Code	Type
S	Magnetically Shielded One Circuit Type

**5** Category

Code	Category
N	For General

**6** Impedance

Typical impedance at 100MHz is expressed by three figures. The unit is in ohm ( $\Omega$ ). The first and second figures are significant digits, and the third figure expresses the number of zeros that follow the two figures.

**7** Circuit

Code	Circuit
H	Expressed by a letter.

**8** Features (2)

Code	Features
Z	Infotainment
H	For Automotive Powertrain, Safety

**9** Number of Signal Lines

Code	Number of Signal Lines
2	Two Lines

**10** Packaging

Code	Packaging
L	Embossed Taping ( $\varnothing$ 180mm Reel)
B	Bulk

Chip Ferrite Bead  
 Chip EMIFIL  
 Chip Common Mode Choke Coil  
 Block Type EMIFIL  
 Microchip Transformer (Balun)  
 Inductors for Power Lines  
 Inductors for General Circuits  
 RF Inductors

## Common Mode Choke Coil for Automotive

(Part Number) 

PL	T	10H	H	102	6R0	P	N	B
①	②	③	④	⑤	⑥	⑦	⑧	⑨

### ① Product ID

Product ID	
PL	Common Mode Choke Coils

### ② Type

Code	Type
T	DC Type

### ③ Applications

Code	Applications
10H	For DC Line High-frequency Type
5BP	5.0x5.0mm Size, for DC Lines

### ④ Features (1)

Code	Features	
H	For Automotive	Powertrain, Safety

### ⑤ Impedance

Expressed by three figures. The unit is ohm ( $\Omega$ ). The first and second figures are significant digits, and the third figure expresses the number of zeros that follow the two figures.

### ⑥ Rated Current

Expressed by three figures. The unit is ampere (A). The first and second figures are significant digits, and the third figure expresses the number of zeros that follow the two figures. A decimal point is expressed by the capital letter "R." In this case, all figures are significant digits.

### ⑦ Features (2)

Code	Features
P	Expressed by a letter.
S	

### ⑧ Lead Dimensions

Code	Lead Dimensions
N	No Lead Terminal (SMD)

### ⑨ Packaging

Code	Packaging
B	Bulk
L	Embossed Taping ( $\phi$ 178mm/ $\phi$ 180mm Reel)
K	Embossed Taping ( $\phi$ 330mm Reel)

# Chip Common Mode Choke Coil SMD Type

## DLM11SN\_HZ2 Series 0504/1210(inch/mm)

### Specifications Sheet (with cautions/mounting/packaging)

Infotainment	<a href="https://www.murata.com/products/productdata/8796199714846/QFLC9116.pdf?1608273989000">https://www.murata.com/products/productdata/8796199714846/QFLC9116.pdf?1608273989000</a>
Powertrain/Safety	—

### Appearance/Dimensions

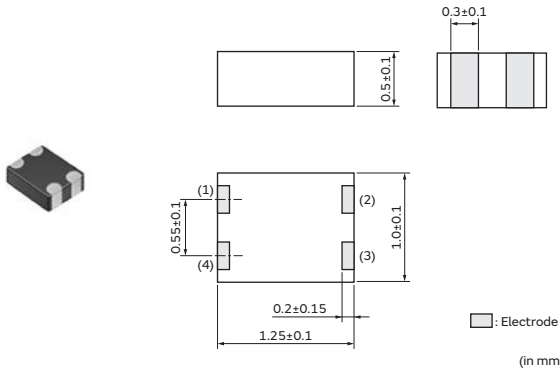

### Packaging

Code	Packaging	Minimum Quantity
L	ø180mm Embossed Tape	4000
B	Bulk(Bag)	500

### Equivalent Circuit

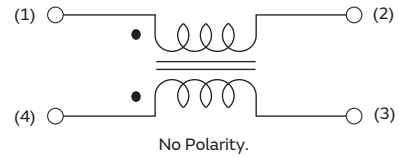

### Rated Value (□: packaging code)

Part Number		Common Mode Impedance at 100MHz	Rated Current	Rated Voltage	Insulation Resistance (Min.)	Withstanding Voltage	DC Resistance
Infotainment	Powertrain/Safety						
DLM11SN450HZ2□	—	45Ω±25%	100mA	5Vdc	100MΩ	12.5Vdc	0.7Ω±25%
DLM11SN900HZ2□	—	90Ω±25%	100mA	5Vdc	100MΩ	12.5Vdc	1.1Ω±25%

Operating Temp. Range: -55°C to 125°C

### Z-f characteristics

Impedance-frequency characteristics (DLM11SN450HZ2)

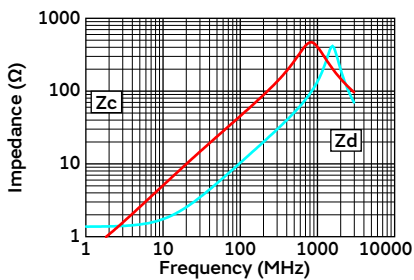

Impedance-frequency characteristics (DLM11SN900HZ2)

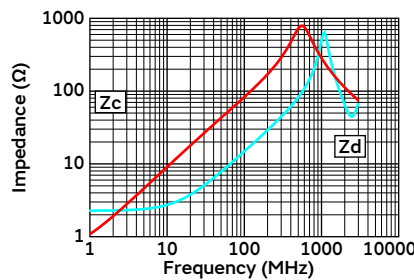



# Chip Common Mode Choke Coil SMD Type

## DLW21SZ\_HQ2 Series 0805/2012(inch/mm)

### Specifications Sheet (with cautions/mounting/packaging)

Infotainment	<a href="https://www.murata.com/products/productdata/8796199747614/QFLC9114.pdf?1544069236000">https://www.murata.com/products/productdata/8796199747614/QFLC9114.pdf?1544069236000</a>
Powertrain/Safety	—

### Appearance/Dimensions

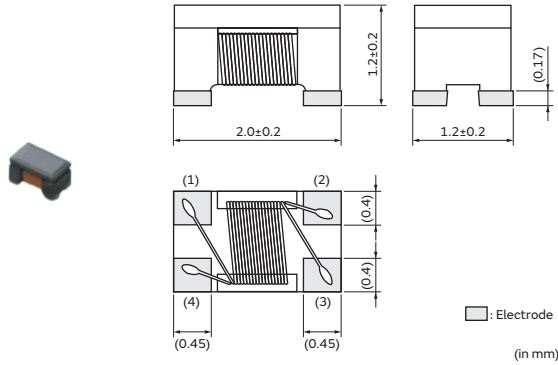

### Packaging

Code	Packaging	Minimum Quantity
L	ø180mm Embossed Tape	2000
B	Bulk(Bag)	500

### Equivalent Circuit

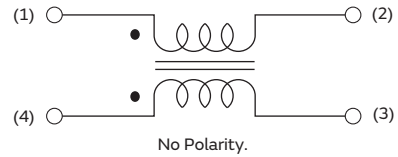

### Rated Value (□: packaging code)

Part Number		Common Mode Impedance at 100MHz	Rated Current	Rated Voltage	Insulation Resistance (Min.)	Withstanding Voltage	DC Resistance
Infotainment	Powertrain/Safety						
DLW21SZ670HQ2□	—	67Ω±25%	320mA	20Vdc	10MΩ	50Vdc	0.31Ω max.
DLW21SZ900HQ2□	—	90Ω±25%	280mA	20Vdc	10MΩ	50Vdc	0.41Ω max.
DLW21SZ121HQ2□	—	120Ω±25%	280mA	20Vdc	10MΩ	50Vdc	0.41Ω max.

Operating Temp. Range: -40°C to 105°C

### Z-f characteristics

Impedance-frequency characteristics (DLW21SZ670HQ2)

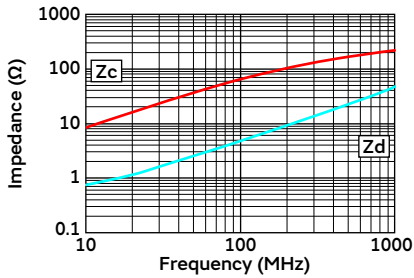

Impedance-frequency characteristics (DLW21SZ900HQ2)

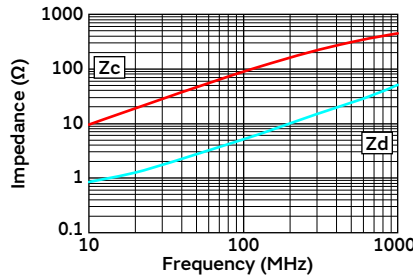

Impedance-frequency characteristics (DLW21SZ121HQ2)

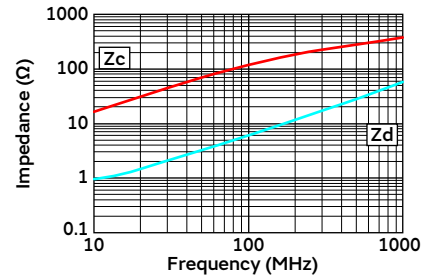

# Chip Common Mode Choke Coil SMD Type

## DLW21SZ\_XQ2 Series 0805/2012(inch/mm)

### Specifications Sheet (with cautions/mounting/packaging)

Infotainment	<a href="https://www.murata.com/products/productdata/8796199780382/QFLC9115.pdf?1544069236000">https://www.murata.com/products/productdata/8796199780382/QFLC9115.pdf?1544069236000</a>
Powertrain/Safety	—

### Appearance/Dimensions

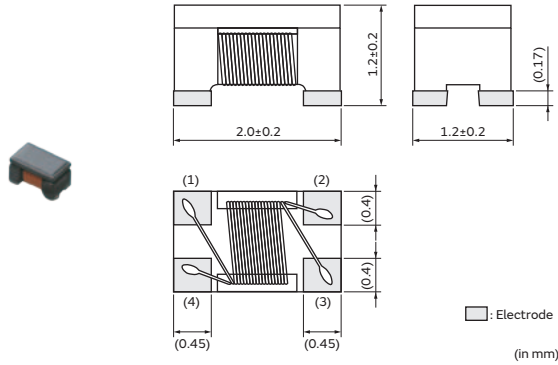

### Packaging

Code	Packaging	Minimum Quantity
L	ø180mm Embossed Tape	2000
B	Bulk(Bag)	500

### Equivalent Circuit

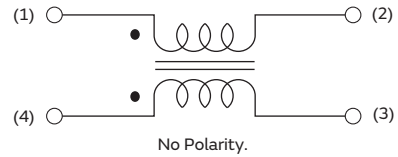

### Rated Value (□: packaging code)

Part Number		Common Mode Impedance at 100MHz	Rated Current	Rated Voltage	Insulation Resistance (Min.)	Withstanding Voltage	DC Resistance
Infotainment	Powertrain/Safety						
DLW21SZ181XQ2□	—	180Ω±25%	240mA	20Vdc	10MΩ	50Vdc	0.39Ω max.
DLW21SZ261XQ2□	—	260Ω±25%	220mA	20Vdc	10MΩ	50Vdc	0.59Ω max.
DLW21SZ491XQ2□	—	490Ω±25%	200mA	20Vdc	10MΩ	50Vdc	0.77Ω max.

Operating Temp. Range: -40°C to 105°C

### Z-f characteristics

Impedance-frequency characteristics (DLW21SZ181XQ2)

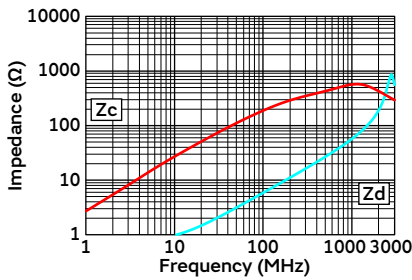

Impedance-frequency characteristics (DLW21SZ261XQ2)

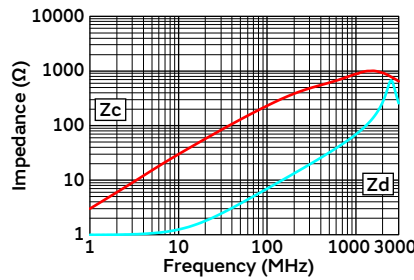

Impedance-frequency characteristics (DLW21SZ491XQ2)

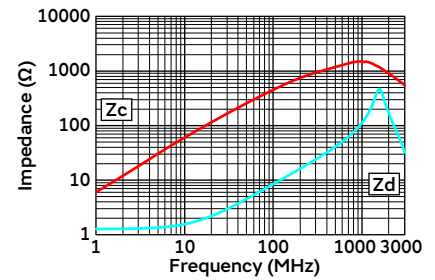

# Chip Common Mode Choke Coil SMD Type

## DLW21SH\_XQ2 Series 0805/2012(inch/mm)

### Specifications Sheet (with cautions/mounting/packaging)

Infotainment	—
Powertrain/Safety	<a href="https://www.murata.com/products/productdata/8812090032158/QFLC9129.pdf?1619484314000">https://www.murata.com/products/productdata/8812090032158/QFLC9129.pdf?1619484314000</a>

### Appearance/Dimensions

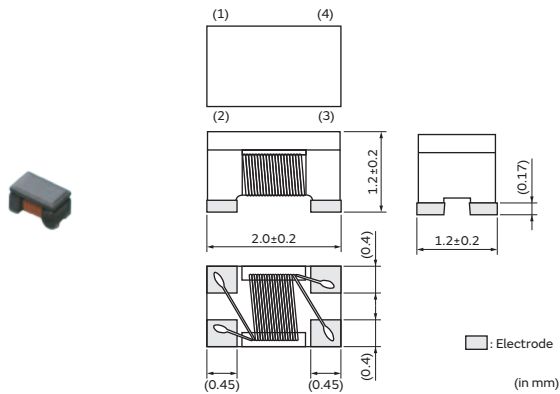

### Packaging

Code	Packaging	Minimum Quantity
L	ø180mm Embossed Tape	2000
B	Bulk(Bag)	500

### Equivalent Circuit

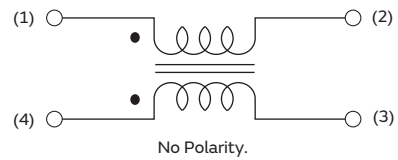

### Rated Value (□: packaging code)

Part Number		Common Mode Impedance at 100MHz	Rated Current	Rated Voltage	Insulation Resistance (Min.)	Withstanding Voltage	DC Resistance
Infotainment	Powertrain/Safety						
—	DLW21SH391XQ2□	390Ω±25%	300mA	20Vdc	10MΩ	50Vdc	0.30Ω±20%

Operating Temp. Range: -40°C to 125°C

### Z-f characteristics

Impedance-frequency characteristics (DLW21SH391XQ2)

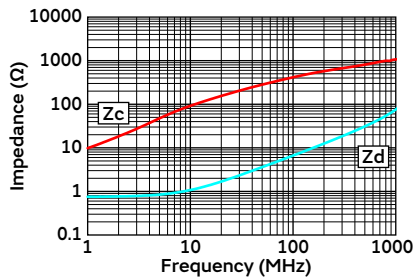

### Derating of Rated Current

In operating temperature exceeding +105°C, derating of current is necessary for this series. Please apply the derating curve shown in chart according to the operating temperature.

#### Derating of Rated Current

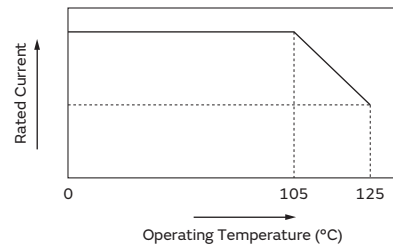

# Chip Common Mode Choke Coil SMD Type

## DLW21PH\_XQ2 Series 0805/2012(inch/mm)

### Specifications Sheet (with cautions/mounting/packaging)

Infotainment	—
Powertrain/Safety	<a href="https://www.murata.com/products/productdata/8812374327326/QFLC9130.pdf?1620975117000">https://www.murata.com/products/productdata/8812374327326/QFLC9130.pdf?1620975117000</a>

### Appearance/Dimensions

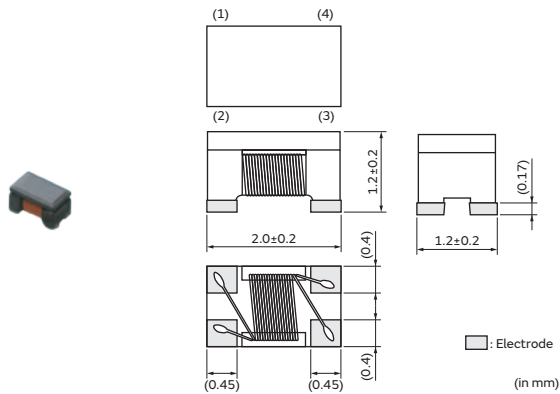

### Packaging

Code	Packaging	Minimum Quantity
L	ø180mm Embossed Tape	2000
B	Bulk(Bag)	500

### Equivalent Circuit

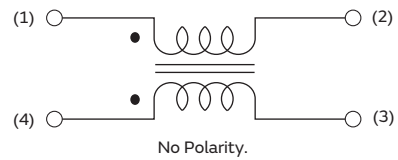

### Rated Value (□: packaging code)

Part Number		Common Mode Impedance at 100MHz	Rated Current	Rated Voltage	Insulation Resistance (Min.)	Withstanding Voltage	DC Resistance
Infotainment	Powertrain/Safety						
—	DLW21PH201XQ2□	200Ω±25%	500mA	20Vdc	10MΩ	50Vdc	0.14Ω±20%

Operating Temp. Range: -40°C to 125°C

### Z-f characteristics

Impedance-frequency characteristics (DLW21PH201XQ2)

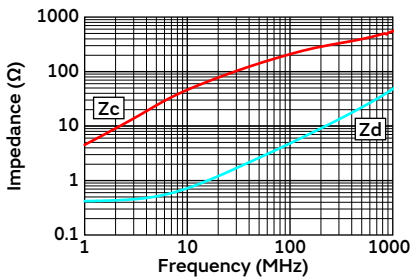

### Derating of Rated Current

In operating temperature exceeding +105°C, derating of current is necessary for this series. Please apply the derating curve shown in chart according to the operating temperature.

#### Derating of Rated Current

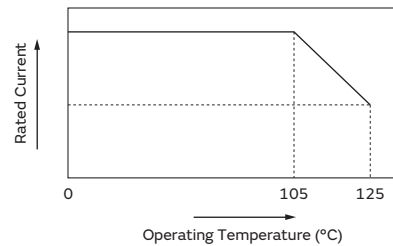

# Chip Common Mode Choke Coil SMD Type

## DLW31SH\_SQ2 Series 1206/3216(inch/mm)

### Specifications Sheet (with cautions/mounting/packaging)

Infotainment	—
Powertrain/Safety	<a href="https://www.murata.com/products/productdata/8796200927262/QFLC9117.pdf?1571182763000">https://www.murata.com/products/productdata/8796200927262/QFLC9117.pdf?1571182763000</a>

### Appearance/Dimensions

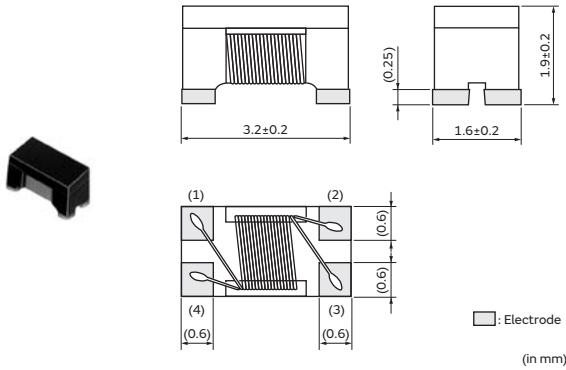

### Packaging

Code	Packaging	Minimum Quantity
L	ø180mm Embossed Tape	2000
B	Bulk(Bag)	500

### Equivalent Circuit

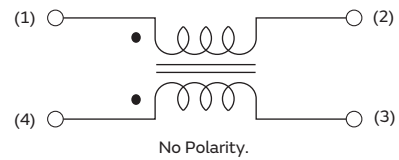

### Rated Value (□: packaging code)

Part Number		Common Mode Impedance at 100MHz	Rated Current	Rated Voltage	Insulation Resistance (Min.)	Withstanding Voltage	DC Resistance
Infotainment	Powertrain/Safety						
—	DLW31SH222SQ2□	2200Ω±25%	80mA	32Vdc	10MΩ	80Vdc	1.6Ω±20%

Operating Temp. Range: -40°C to 125°C

### Z-f characteristics

Impedance-frequency characteristics (DLW31SH222SQ2)

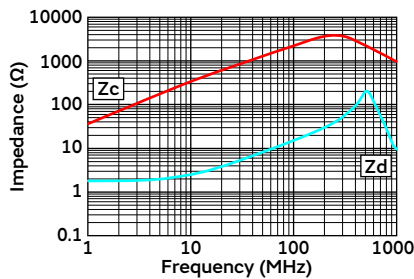

# Chip Common Mode Choke Coil SMD Type

## DLW32MH\_XK2 Series 1210/3225(inch/mm)

### Specifications Sheet (with cautions/mounting/packaging)

Infotainment	—
Powertrain/Safety	<a href="https://www.murata.com/products/productdata/8800985710622/QFLC9124.pdf?1544069236000">https://www.murata.com/products/productdata/8800985710622/QFLC9124.pdf?1544069236000</a>

### Appearance/Dimensions

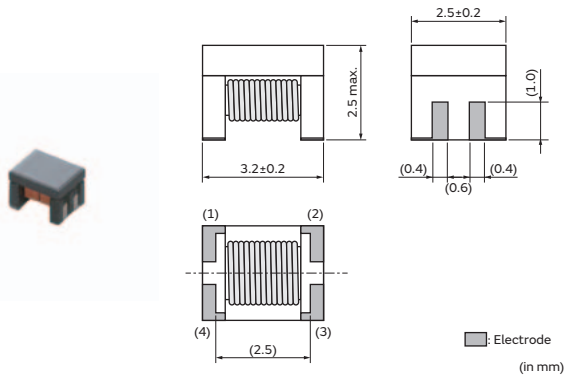

### Packaging

Code	Packaging	Minimum Quantity
L	ø180mm Embossed Tape	1500
B	Bulk(Bag)	500

### Equivalent Circuit

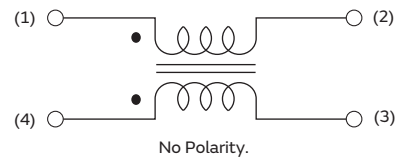

### Rated Value (□: packaging code)

Part Number		Common Mode Inductance	Rated Current	Rated Voltage	Insulation Resistance (Min.)	Withstanding Voltage	DC Resistance
Infotainment	Powertrain/Safety						
—	DLW32MH101XK2□	100μH-30%/+50% (at 0.1MHz)	100mA	50Vdc	10MΩ	125Vdc	2.8Ω±20%
—	DLW32MH201XK2□	200μH-20%/+50% (at 0.1MHz)	70mA	50Vdc	10MΩ	125Vdc	4.0Ω±20%

Operating Temp. Range: -40°C to 125°C

### Z-f characteristics

Impedance-frequency characteristics (DLW32MH101XK2)

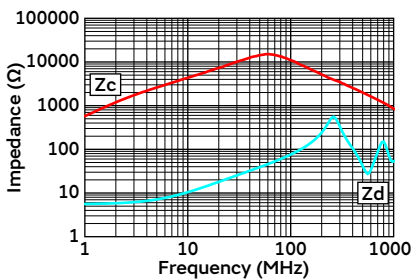

Impedance-frequency characteristics (DLW32MH201XK2)

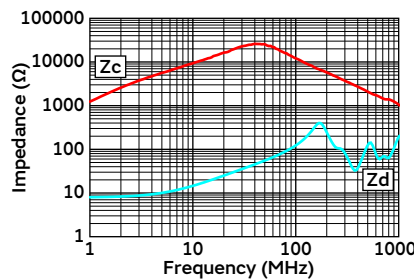

# Chip Common Mode Choke Coil SMD Type

## DLW32MH\_XT2 Series 1210/3225(inch/mm)

### Specifications Sheet (with cautions/mounting/packaging)

Infotainment	—
Powertrain/Safety	<a href="https://www.murata.com/products/productdata/8803304505374/QFLC9125.pdf?1626138266000">https://www.murata.com/products/productdata/8803304505374/QFLC9125.pdf?1626138266000</a>

### Appearance/Dimensions

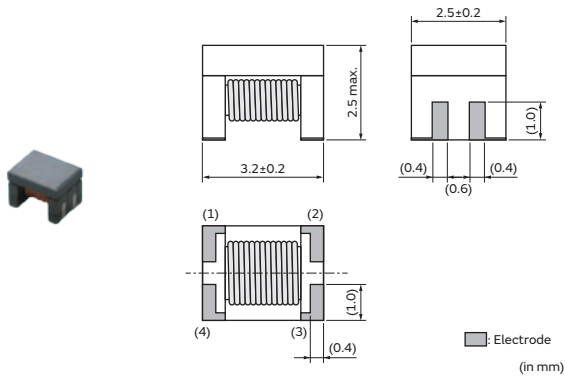

### Packaging

Code	Packaging	Minimum Quantity
L	ø180mm Embossed Tape	1500
B	Bulk(Bag)	500

### Equivalent Circuit

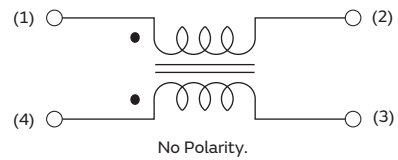

### Rated Value (□: packaging code)

Part Number		Common Mode Inductance	Rated Current	Rated Voltage	Insulation Resistance (Min.)	Withstanding Voltage	DC Resistance
Infotainment	Powertrain/Safety						
—	DLW32MH101XT2□	100μH (Typ.) at 500mV,0.1MHz 80μH -25%/+50% at 100mV,0.1MHz	100mA	50Vdc	10MΩ	125Vdc	2.6Ω±20%

Operating Temp. Range: -40°C to 125°C

### Z-f characteristics

Impedance-frequency characteristics (DLW32MH101XT2)

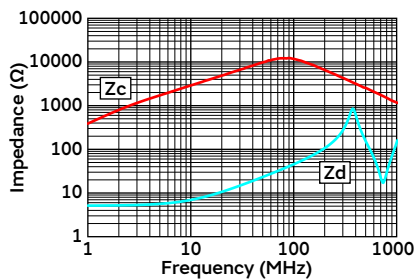



# Chip Common Mode Choke Coil SMD Type

## DLW32SH\_XF2 Series 1210/3225(inch/mm)

### Specifications Sheet (with cautions/mounting/packaging)

Infotainment	—
Powertrain/Safety	<a href="https://www.murata.com/products/productdata/8804913741854/QFLC9127.pdf?1626138266000">https://www.murata.com/products/productdata/8804913741854/QFLC9127.pdf?1626138266000</a>

### Appearance/Dimensions

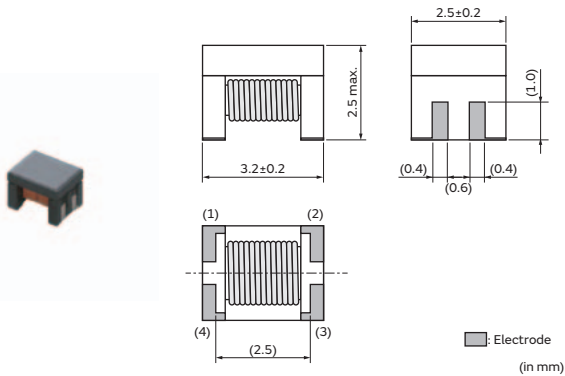

### Packaging

Code	Packaging	Minimum Quantity
L	ø180mm Embossed Tape	1500
B	Bulk(Bag)	500

### Equivalent Circuit

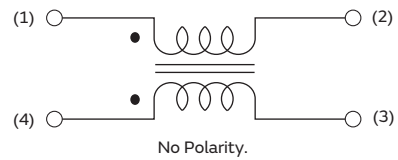

### Rated Value (□: packaging code)

Part Number		Common Mode Inductance	Rated Current	Rated Voltage	Insulation Resistance (Min.)	Withstanding Voltage	DC Resistance
Infotainment	Powertrain/Safety						
—	DLW32SH101XF2□	100μH-30%/+50% (at 0.1MHz)	115mA	50Vdc	10MΩ	125Vdc	2.1Ω max.

Operating Temp. Range: -40°C to 125°C

### Z-f characteristics

Impedance-frequency characteristics (DLW32SH101XF2)

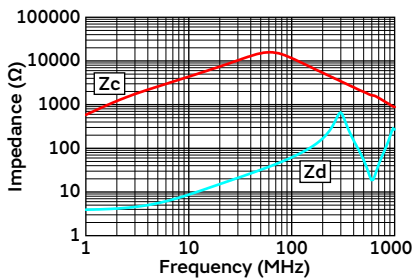

# Chip Common Mode Choke Coil SMD Type

## DLW43MH\_XK2 Series 1812/4532(inch/mm)

### Specifications Sheet (with cautions/mounting/packaging)

Infotainment	—
Powertrain/Safety	<a href="https://www.murata.com/products/productdata/8798622449694/QFLC9118.pdf?1544069236000">https://www.murata.com/products/productdata/8798622449694/QFLC9118.pdf?1544069236000</a>

### Appearance/Dimensions

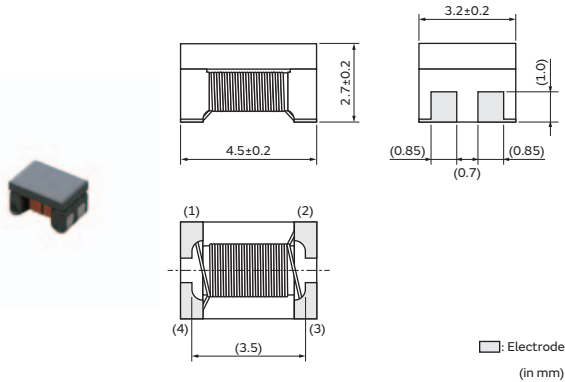

### Packaging

Code	Packaging	Minimum Quantity
K	ø330mm Embossed Tape	2500
L	ø180mm Embossed Tape	500
B	Bulk(Bag)	100

### Equivalent Circuit

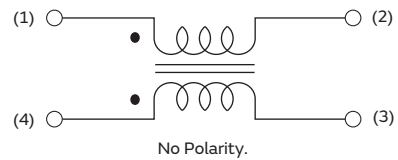

### Rated Value (□: packaging code)

Part Number		Common Mode Inductance	Rated Current	Rated Voltage	Insulation Resistance (Min.)	Withstanding Voltage	DC Resistance
Infotainment	Powertrain/Safety						
—	DLW43MH201XK2□	200μH-25%/+50% (at 0.1MHz)	110mA	20Vdc	10MΩ	50Vdc	4.5Ω max.

Operating Temp. Range: -40°C to 105°C

### Z-f characteristics

Impedance-frequency characteristics (DLW43MH201XK2)

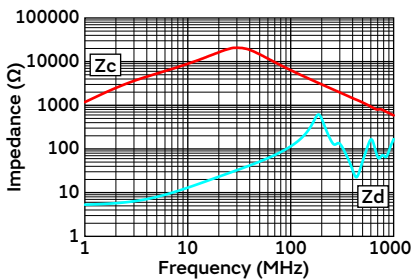

# Chip Common Mode Choke Coil SMD Type

## DLW43SH\_XK2 Series 1812/4532(inch/mm)

### Specifications Sheet (with cautions/mounting/packaging)

Infotainment	—
Powertrain/Safety	<a href="https://www.murata.com/products/productdata/8796199813150/QFLC9101.pdf?1619744971000">https://www.murata.com/products/productdata/8796199813150/QFLC9101.pdf?1619744971000</a>

### Appearance/Dimensions

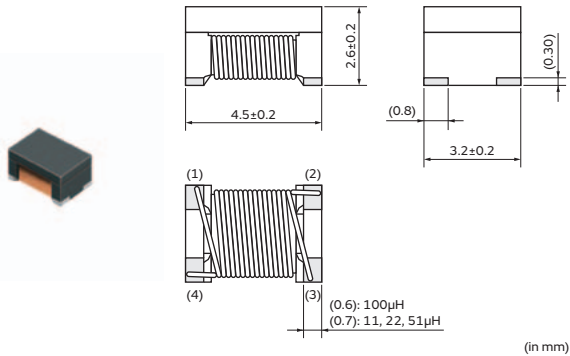

### Packaging

Code	Packaging	Minimum Quantity
K	ø330mm Embossed Tape	2500
L	ø180mm Embossed Tape	500
B	Bulk(Bag)	100

### Equivalent Circuit

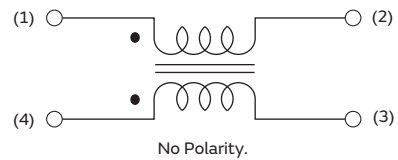

### Rated Value (□: packaging code)

Part Number		Common Mode Inductance	Rated Current	Rated Voltage	Insulation Resistance (Min.)	Withstanding Voltage	DC Resistance
Infotainment	Powertrain/Safety						
—	DLW43SH110XK2□	11µH-30%/+50% (at 0.1MHz)	360mA	50Vdc	10MΩ	125Vdc	0.5Ω max.
—	DLW43SH220XK2□	22µH-30%/+50% (at 0.1MHz)	310mA	50Vdc	10MΩ	125Vdc	0.6Ω max.
—	DLW43SH510XK2□	51µH-30%/+50% (at 1MHz)	230mA	50Vdc	10MΩ	125Vdc	1.0Ω max.
—	DLW43SH101XK2□	100µH-30%/+50% (at 1MHz)	200mA	50Vdc	10MΩ	125Vdc	2.0Ω max.

Operating Temp. Range: -40°C to 125°C

### Z-f characteristics

Impedance-frequency characteristics (DLW43SH110XK2)

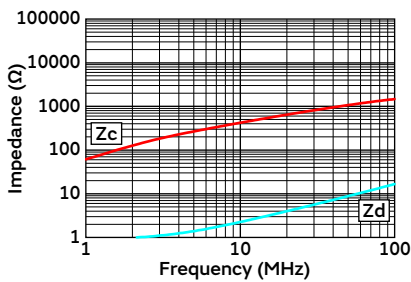

Impedance-frequency characteristics (DLW43SH220XK2)

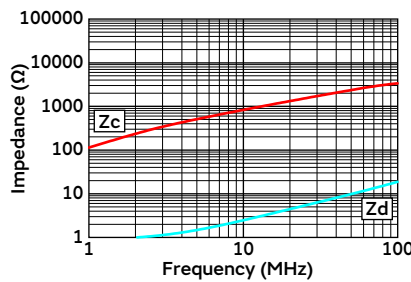

Impedance-frequency characteristics (DLW43SH510XK2)

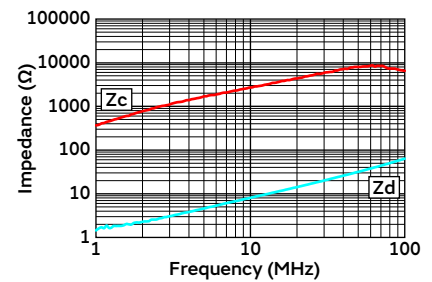

Impedance-frequency characteristics (DLW43SH101XK2)

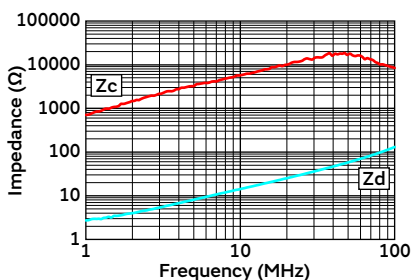

# Chip Common Mode Choke Coil SMD Type

## DLW5ATZ\_MQ2/DLW5ATH\_MQ2 Series 2014/5036(inch/mm)

### Specifications Sheet (with cautions/mounting/packaging)

Infotainment	<a href="https://www.murata.com/products/productdata/8796199878686/QFLC9109.pdf?1601957484000">https://www.murata.com/products/productdata/8796199878686/QFLC9109.pdf?1601957484000</a>
Powertrain/Safety	<a href="https://www.murata.com/products/productdata/8799449284638/QFLC9122.pdf?1544069236000">https://www.murata.com/products/productdata/8799449284638/QFLC9122.pdf?1544069236000</a>

### Appearance/Dimensions

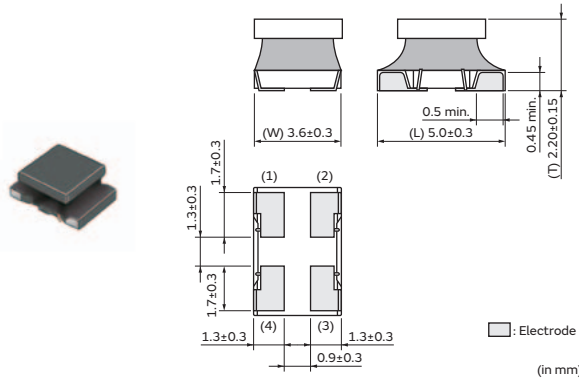

### Packaging

Code	Packaging	Minimum Quantity
K	ø330mm Embossed Tape	2500
L	ø180mm Embossed Tape	700
B	Bulk(Bag)	100

### Equivalent Circuit

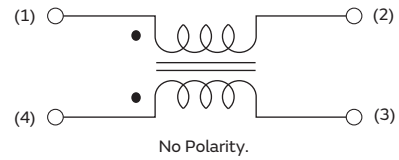

### Rated Value (□: packaging code)

Part Number		Common Mode Impedance at 10MHz	Common Mode Impedance at 100MHz	Rated Current	Rated Voltage	Insulation Resistance (Min.)	Withstanding Voltage	DC Resistance
Infotainment	Powertrain/Safety							
<a href="#">DLW5ATZ500MQ2</a> □	<a href="#">DLW5ATH500MQ2</a> □	4.6Ωmin.	50Ω(Typ.)	4A	100Vdc/50Vdc	10MΩ	250Vdc/125Vdc	0.013Ω max.
<a href="#">DLW5ATZ151MQ2</a> □	<a href="#">DLW5ATH151MQ2</a> □	11Ωmin.	150Ω(Typ.)	3A	100Vdc/50Vdc	10MΩ	250Vdc/125Vdc	0.020Ω max.
<a href="#">DLW5ATZ331MQ2</a> □	<a href="#">DLW5ATH331MQ2</a> □	20Ωmin.	330Ω(Typ.)	2.5A	100Vdc/50Vdc	10MΩ	250Vdc/125Vdc	0.027Ω max.
<a href="#">DLW5ATZ501MQ2</a> □	<a href="#">DLW5ATH501MQ2</a> □	35Ωmin.	500Ω(Typ.)	2A	100Vdc/50Vdc	10MΩ	250Vdc/125Vdc	0.034Ω max.
<a href="#">DLW5ATZ112MQ2</a> □	<a href="#">DLW5ATH112MQ2</a> □	50Ωmin.	1100Ω(Typ.)	1.5A	100Vdc/50Vdc	10MΩ	250Vdc/125Vdc	0.056Ω max.

Operating Temp. Range: -40°C to 105°C/-40°C to 125°C

### Z-f characteristics

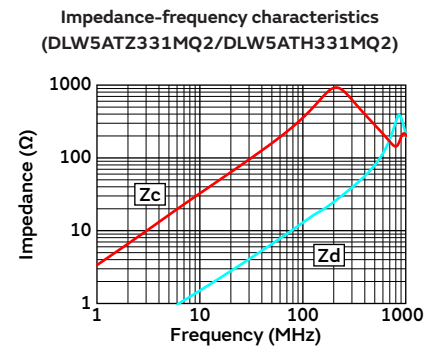
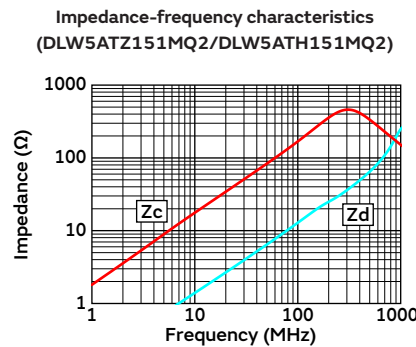
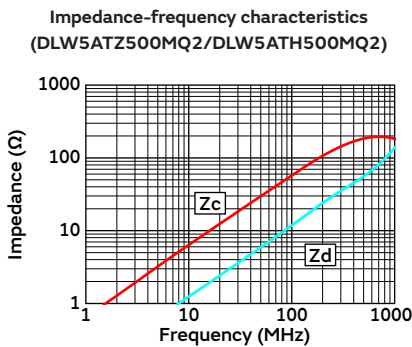

Continued on the following page. ↗

Continued from the preceding page. ↘

## Z-f characteristics

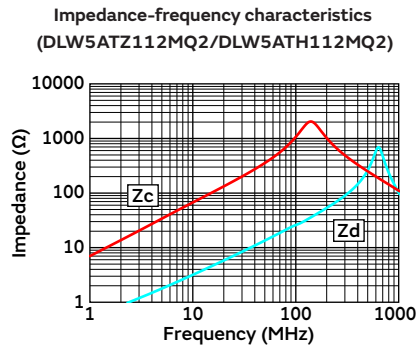
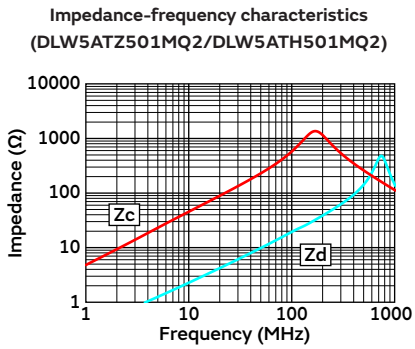

## Derating of Rated Current

In operating temperature exceeding +105°C, derating of current is necessary for DLW5ATH\_MQ2 series. Please apply the derating curve shown in chart according to the operating temperature.

Derating of Rated Current

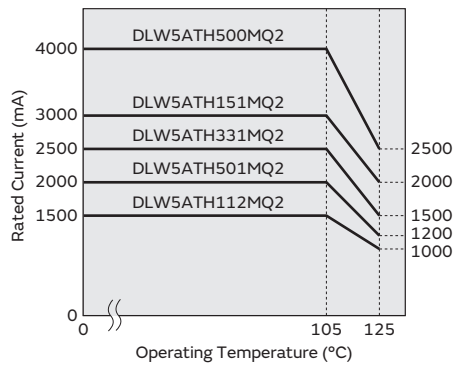

Chip Ferrite Bead

Chip EMIFIL

Chip Common Mode Choke Coil

Block Type EMIFIL

Microchip Transformer (Balun)

Inductors for Power Lines

Inductors for General Circuits

RF Inductors

# Chip Common Mode Choke Coil SMD Type

## DLW5ATZ\_TQ2/DLW5ATH\_TQ2 Series 2014/5036(inch/mm)

### Specifications Sheet (with cautions/mounting/packaging)

Infotainment	<a href="https://www.murata.com/products/productdata/8796199911454/QFLC9110.pdf?1601957484000">https://www.murata.com/products/productdata/8796199911454/QFLC9110.pdf?1601957484000</a>
Powertrain/Safety	<a href="https://www.murata.com/products/productdata/8799449251870/QFLC9121.pdf?1544069236000">https://www.murata.com/products/productdata/8799449251870/QFLC9121.pdf?1544069236000</a>

### Appearance/Dimensions

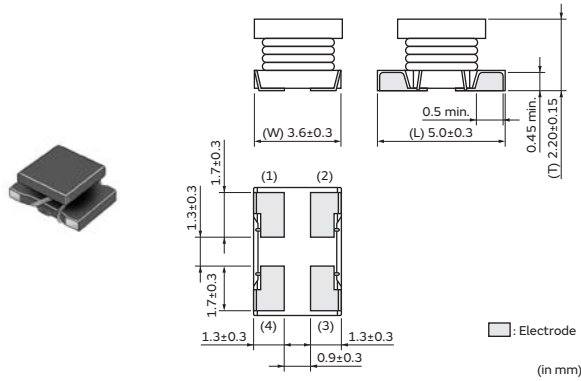

### Packaging

Code	Packaging	Minimum Quantity
K	ø330mm Embossed Tape	2500
L	ø180mm Embossed Tape	700
B	Bulk(Bag)	100

### Equivalent Circuit

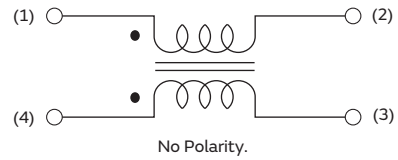

### Rated Value (□: packaging code)

Part Number		Common Mode Impedance at 10MHz	Common Mode Impedance at 100MHz	Rated Current	Rated Voltage	Insulation Resistance (Min.)	Withstanding Voltage	DC Resistance
Infotainment	Powertrain/Safety							
DLW5ATZ450TQ2□	DLW5ATH450TQ2□	4.7Ω±25%	45Ω(Typ.)	4A	100Vdc/50Vdc	10MΩ	250Vdc/125Vdc	0.013Ω max.
DLW5ATZ111TQ2□	DLW5ATH111TQ2□	12Ω±25%	110Ω(Typ.)	3A	100Vdc/50Vdc	10MΩ	250Vdc/125Vdc	0.020Ω max.
DLW5ATZ231TQ2□	DLW5ATH231TQ2□	22Ω±25%	230Ω(Typ.)	2.5A	100Vdc/50Vdc	10MΩ	250Vdc/125Vdc	0.027Ω max.
DLW5ATZ401TQ2□	DLW5ATH401TQ2□	35Ω±25%	400Ω(Typ.)	2A	100Vdc/50Vdc	10MΩ	250Vdc/125Vdc	0.034Ω max.
DLW5ATZ501TQ2□	DLW5ATH501TQ2□	55Ω±25%	500Ω(Typ.)	1.5A	100Vdc/50Vdc	10MΩ	250Vdc/125Vdc	0.056Ω max.

Operating Temp. Range: -40°C to 105°C/-40°C to 125°C

### Z-f characteristics

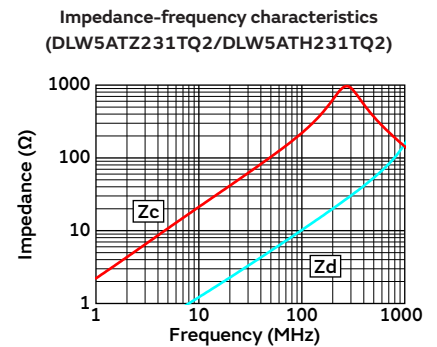
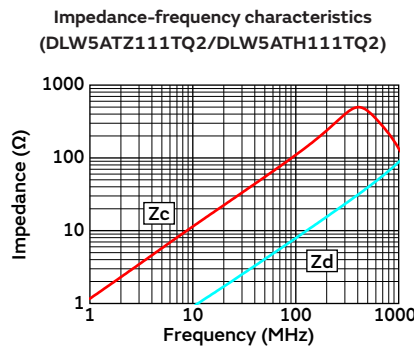
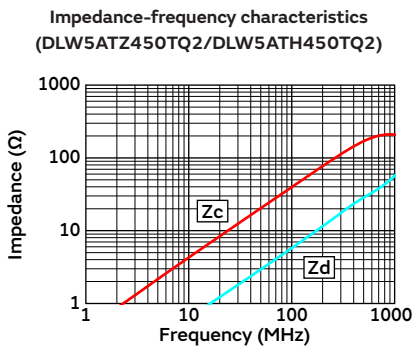

Continued on the following page. ↗

Continued from the preceding page. ↘

## Z-f characteristics

Impedance-frequency characteristics  
 (DLW5ATZ401TQ2/DLW5ATH401TQ2)

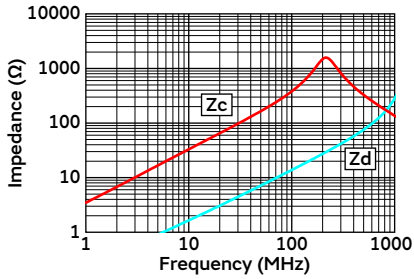

Impedance-frequency characteristics  
 (DLW5ATZ501TQ2/DLW5ATH501TQ2)

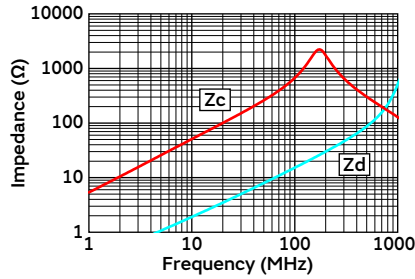

## Derating of Rated Current

In operating temperature exceeding +105°C, derating of current is necessary for DLW5ATH\_TQ2 series. Please apply the derating curve shown in chart according to the operating temperature.

Derating of Rated Current

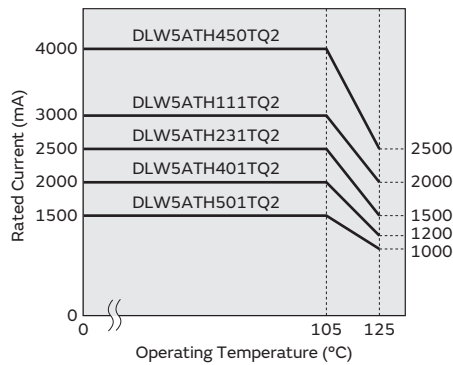



# Chip Common Mode Choke Coil SMD Type

## DLW5BSZ\_TQ2 Series 2020/5050(inch/mm)

### Specifications Sheet (with cautions/mounting/packaging)

Infotainment	<a href="https://www.murata.com/products/productdata/8796199944222/QFLC9112.pdf?1544069235000">https://www.murata.com/products/productdata/8796199944222/QFLC9112.pdf?1544069235000</a>
Powertrain/Safety	—

### Appearance/Dimensions

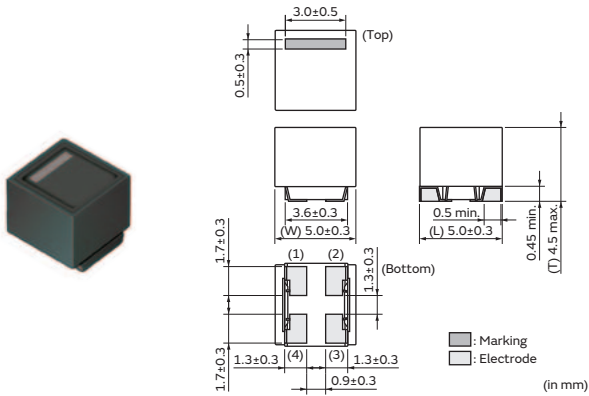

### Packaging

Code	Packaging	Minimum Quantity
K	ø330mm Embossed Tape	1500
L	ø180mm Embossed Tape	400
B	Bulk(Bag)	100

### Equivalent Circuit

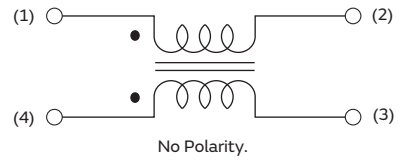

### Rated Value (□: packaging code)

Part Number		Common Mode Impedance at 10MHz	Common Mode Impedance at 100MHz	Rated Current	Rated Voltage	Insulation Resistance (Min.)	Withstanding Voltage	DC Resistance
Infotainment	Powertrain/Safety							
DLW5BSZ501TQ2□	—	2800Ω±40%	500Ω(Typ.)	700mA	50Vdc	10MΩ	125Vdc	0.23Ω max.
DLW5BSZ601TQ2□	—	1200Ω±40%	600Ω(Typ.)	1A	50Vdc	10MΩ	125Vdc	0.12Ω max.
DLW5BSZ801TQ2□	—	550Ω±40%	800Ω(Typ.)	1.5A	50Vdc	10MΩ	125Vdc	0.056Ω max.

Operating Temp. Range: -40°C to 105°C

### Z-f characteristics

Impedance-frequency characteristics (DLW5BSZ501TQ2)

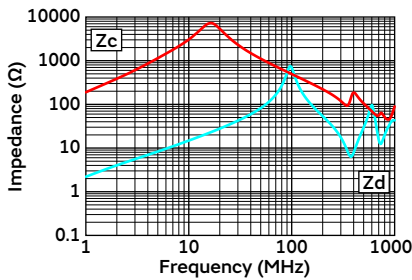

Impedance-frequency characteristics (DLW5BSZ601TQ2)

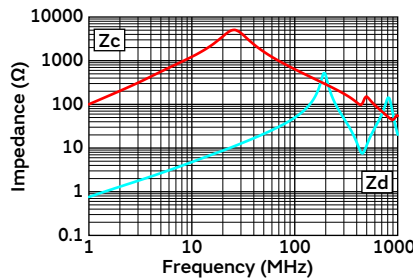

Impedance-frequency characteristics (DLW5BSZ801TQ2)

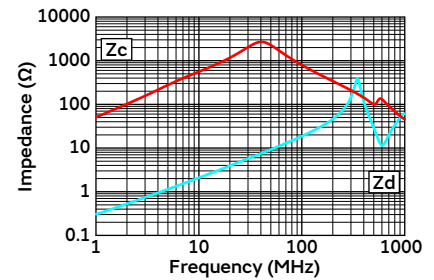

# Chip Common Mode Choke Coil SMD Type

## DLW5BTZ\_TQ2/DLW5BTH\_TQ2 Series 2020/5050(inch/mm)

### Specifications Sheet (with cautions/mounting/packaging)

Infotainment	<a href="https://www.murata.com/products/productdata/8796199976990/QFLC9108.pdf?1601957484000">https://www.murata.com/products/productdata/8796199976990/QFLC9108.pdf?1601957484000</a>
Powertrain/Safety	<a href="https://www.murata.com/products/productdata/8799449120798/QFLC9120.pdf?1544069236000">https://www.murata.com/products/productdata/8799449120798/QFLC9120.pdf?1544069236000</a>

### Appearance/Dimensions

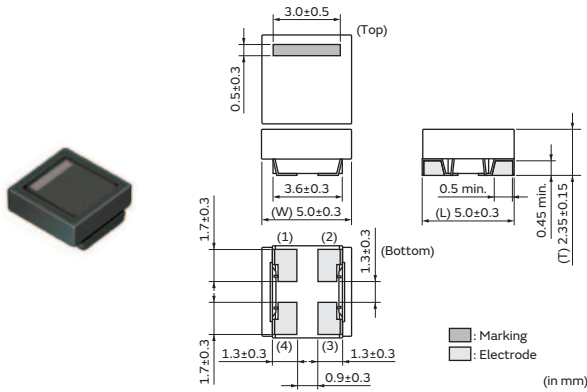

### Packaging

Code	Packaging	Minimum Quantity
K	ø330mm Embossed Tape	2500
L	ø180mm Embossed Tape	700
B	Bulk(Bag)	100

### Equivalent Circuit

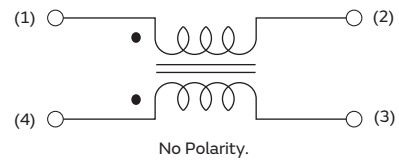

### Rated Value (□: packaging code)

Part Number		Common Mode Impedance at 10MHz	Common Mode Impedance at 100MHz	Rated Current	Rated Voltage	Insulation Resistance (Min.)	Withstanding Voltage	DC Resistance
Infotainment	Powertrain/Safety							
DLW5BTZ101TQ2□	DLW5BTH101TQ2□	10Ωmin.	100Ω(Typ.)	4A	100Vdc/50Vdc	10MΩ	250Vdc/125Vdc	0.013Ω max.
DLW5BTZ251TQ2□	DLW5BTH251TQ2□	20Ωmin.	250Ω(Typ.)	3A	100Vdc/50Vdc	10MΩ	250Vdc/125Vdc	0.020Ω max.
DLW5BTZ501TQ2□	DLW5BTH501TQ2□	30Ωmin.	500Ω(Typ.)	2.5A	100Vdc/50Vdc	10MΩ	250Vdc/125Vdc	0.027Ω max.
DLW5BTZ102TQ2□	DLW5BTH102TQ2□	60Ωmin.	1000Ω(Typ.)	2A	100Vdc/50Vdc	10MΩ	250Vdc/125Vdc	0.034Ω max.
DLW5BTZ142TQ2□	DLW5BTH142TQ2□	100Ωmin.	1400Ω(Typ.)	1.5A	100Vdc/50Vdc	10MΩ	250Vdc/125Vdc	0.056Ω max.

Operating Temp. Range: -40°C to 105°C/-40°C to 125°C

### Z-f characteristics

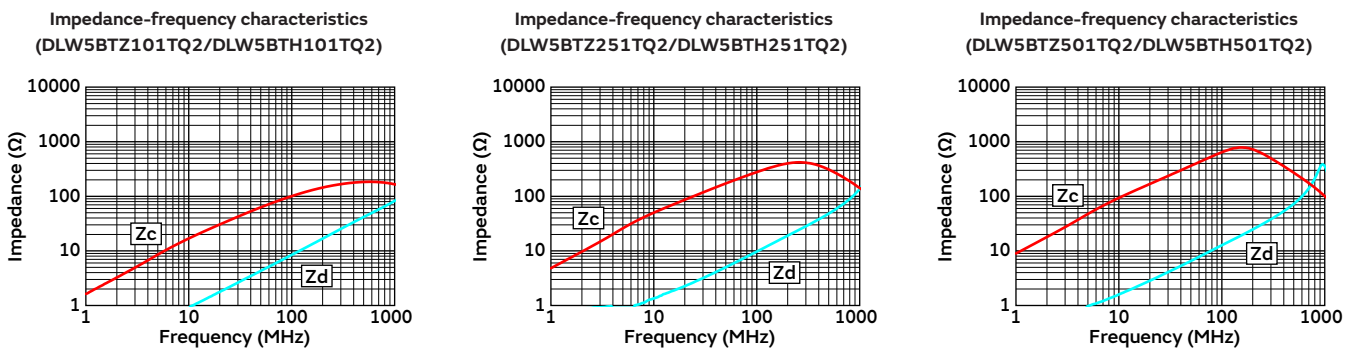

Continued on the following page. ↗

Chip Ferrite Bead  
 Chip EMIFIL  
 Chip Common Mode Choke Coil  
 Block Type EMIFIL  
 Microchip Transformer (Ballun)  
 Inductors for Power Lines  
 Inductors for General Circuits  
 RF Inductors

Continued from the preceding page. ↘

## Z-f characteristics

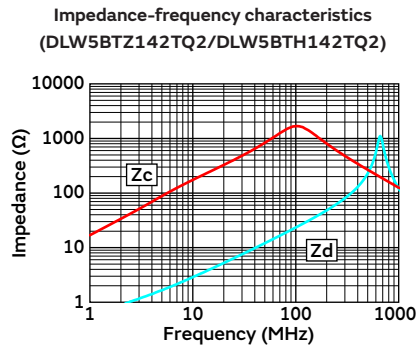
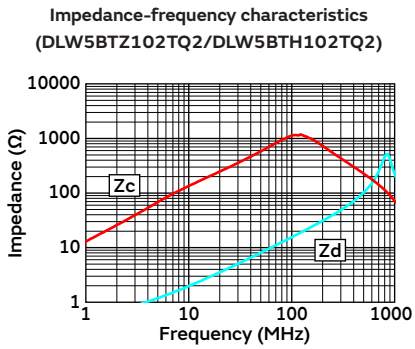

## Derating of Rated Current

In operating temperature exceeding +105°C, derating of current is necessary for DLW5BTH\_TQ2 series. Please apply the derating curve shown in chart according to the operating temperature.

Derating of Rated Current

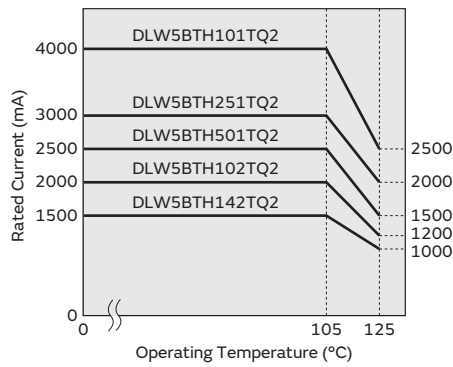

# Chip Common Mode Choke Coil SMD Type

## PLT5BPH\_SN Series 2020/5050(inch/mm)

### Specifications Sheet (with cautions/mounting/packaging)

Infotainment	—
Powertrain/Safety	<a href="https://www.murata.com/products/productdata/8796200992798/QFLB9102.pdf?1618194763000">https://www.murata.com/products/productdata/8796200992798/QFLB9102.pdf?1618194763000</a>

### Appearance/Dimensions

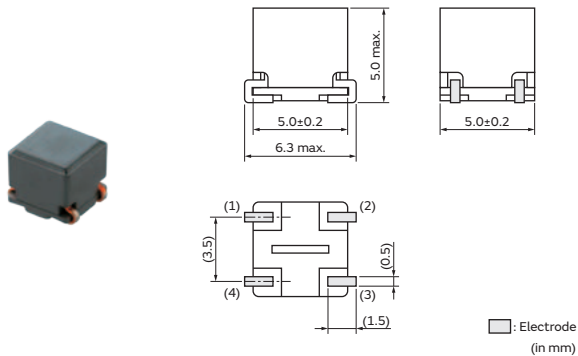

### Packaging

Code	Packaging	Minimum Quantity
L	ø180mm Embossed Tape	300
B	Bulk(Bag)	50

### Equivalent Circuit

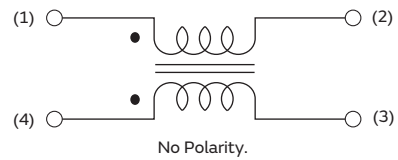

### Rated Value (□: packaging code)

Part Number		Common Mode Impedance at 10MHz	Rated Current	Rated Voltage	Insulation Resistance (Min.)	Withstanding Voltage	DC Resistance
Infotainment	Powertrain/Safety						
—	PLT5BPH1015R6SN□	100Ω(Typ.)	5.6A	80Vdc	10MΩ	200Vdc	4mΩ±30%
—	PLT5BPH2014R4SN□	200Ω(Typ.)	4.4A	80Vdc	10MΩ	200Vdc	7mΩ±30%
—	PLT5BPH3013R7SN□	300Ω(Typ.)	3.7A	80Vdc	10MΩ	200Vdc	11mΩ±30%
—	PLT5BPH5013R1SN□	500Ω(Typ.)	3.1A	80Vdc	10MΩ	200Vdc	17mΩ±30%

Operating Temp. Range: -55°C to 150°C

### Z-f characteristics

Impedance-frequency characteristics (PLT5BPH1015R6SN)

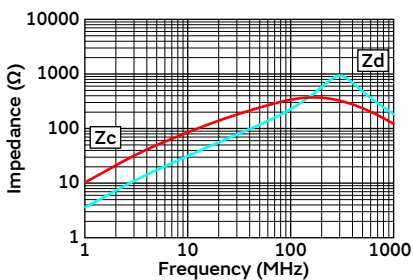

Impedance-frequency characteristics (PLT5BPH2014R4SN)

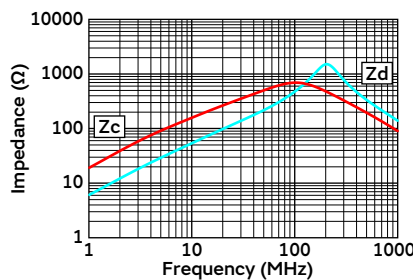

Impedance-frequency characteristics (PLT5BPH3013R7SN)

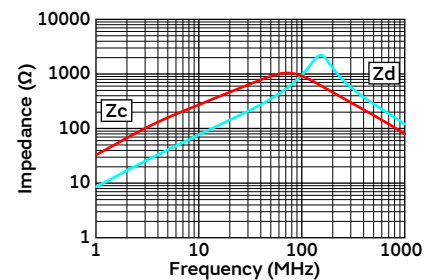

Impedance-frequency characteristics (PLT5BPH5013R1SN)

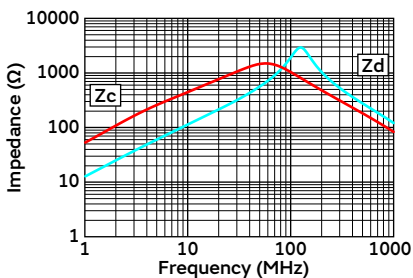

Continued on the following page. ↗

Continued from the preceding page. ↘

## Derating of Rated Current

In operating temperature exceeding +125°C, derating of current is necessary for PLT5BP series.  
 Please apply the derating curve shown in chart according to the operating temperature.

Derating of Rated Current

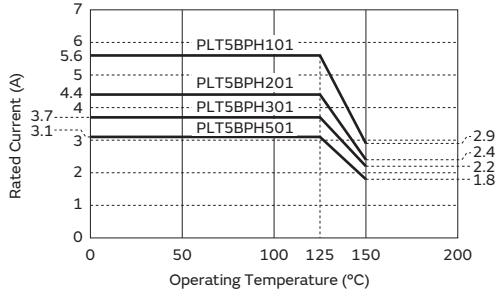

# Chip Common Mode Choke Coil SMD Type

## PLT10HH\_PN Series

### Specifications Sheet (with cautions/mounting/packaging)

Infotainment	—
Powertrain/Safety	<a href="https://www.murata.com/products/productdata/8796200108062/QFLB9101.pdf?1558395620000">https://www.murata.com/products/productdata/8796200108062/QFLB9101.pdf?1558395620000</a>

### Appearance/Dimensions

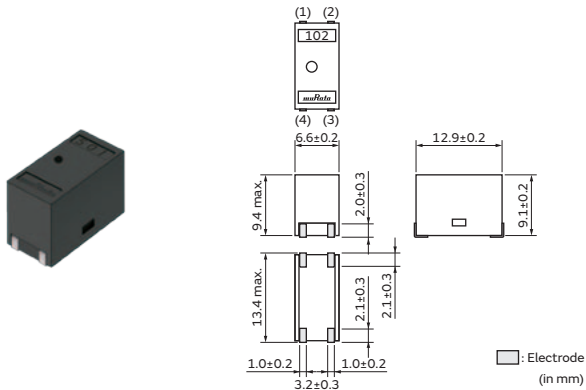

### Packaging

Code	Packaging	Minimum Quantity
K	ø330mm Embossed Tape	500
L	ø180mm Embossed Tape	125
B	Bulk(Bag)	50

### Equivalent Circuit

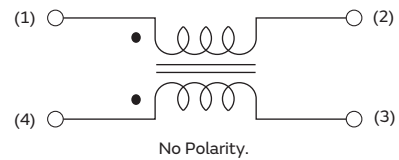

### Rated Value (□: packaging code)

Part Number		Common Mode Impedance at 10MHz	Common Mode Inductance	Rated Current	Rated Voltage	Insulation Resistance (Min.)	Withstanding Voltage	DC Resistance	Operating Temp. Range
Infotainment	Powertrain/Safety								
—	PLT10HH450180PN□	45Ω(Typ.)	0.8μHmin.	18A	300Vdc	10MΩ	750Vdc	1.3mΩ±0.5mΩ	-55°C to 125°C
—	PLT10HH101150PN□	100Ω(Typ.)	2.0μHmin.	15A	300Vdc	10MΩ	750Vdc	1.8mΩ±0.5mΩ	-55°C to 125°C
—	PLT10HH401100PN□	400Ω(Typ.)	6μHmin.	10A	100Vdc	10MΩ	250Vdc	3.6mΩ±0.5mΩ	-55°C to 125°C
—	PLT10HH501100PN□	500Ω(Typ.)	9μHmin.	10A	100Vdc	10MΩ	250Vdc	3.6mΩ±0.5mΩ	-55°C to 105°C
—	PLT10HH9016R0PN□	900Ω(Typ.)	14μHmin.	6A	100Vdc	10MΩ	250Vdc	8.0mΩ±0.5mΩ	-55°C to 125°C
—	PLT10HH1026R0PN□	1000Ω(Typ.)	20μHmin.	6A	100Vdc	10MΩ	250Vdc	8.0mΩ±0.5mΩ	-55°C to 105°C

Operating temperature should include self-temperature rise.

### Z-f characteristics

Impedance-frequency characteristics (PLT10HH450180PN)

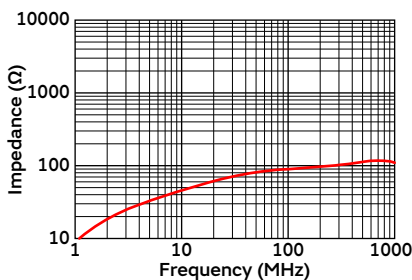

Impedance-frequency characteristics (PLT10HH101150PN)

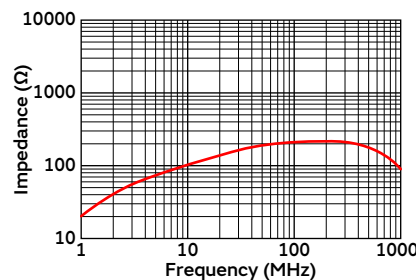

Impedance-frequency characteristics (PLT10HH401100PN)

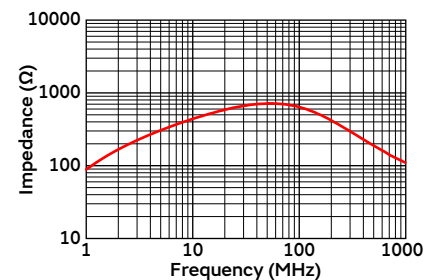

Continued on the following page. ↗

Continued from the preceding page. ↘

## Z-f characteristics

Impedance-frequency characteristics (PLT10HH501100PN)

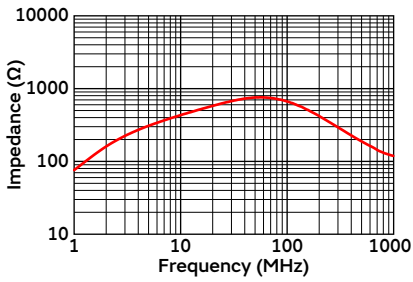

Impedance-frequency characteristics (PLT10HH9016R0PN)

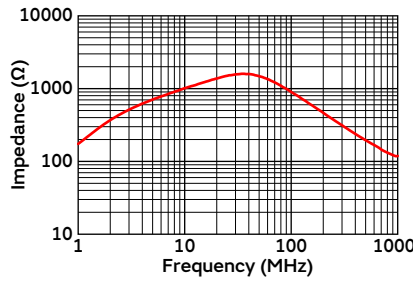

Impedance-frequency characteristics (PLT10HH1026R0PN)

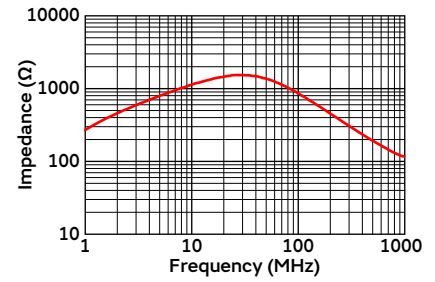

## Derating of Rated Current

In operating temperature exceeding +65°C, derating of current is necessary for PLT10H series. Please apply the derating curve shown in chart according to the operating temperature.

Derating of Rated Current

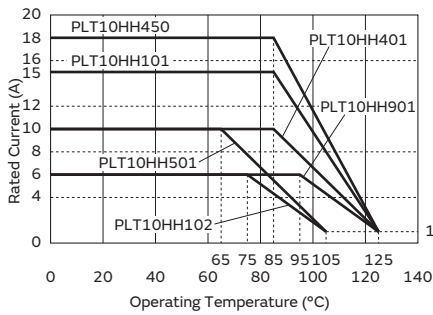



# Chip Common Mode Choke Coil SMD Type

## UCMH Series 3527/9070(inch/mm)

### Specifications Sheet (with cautions/mounting/packaging)

Infotainment	<a href="https://www.murata.com/products/productdata/8798755815454/REF-UCMH0907.pdf?1625622689000">https://www.murata.com/products/productdata/8798755815454/REF-UCMH0907.pdf?1625622689000</a>
Powertrain/Safety	—

### Appearance/Dimensions

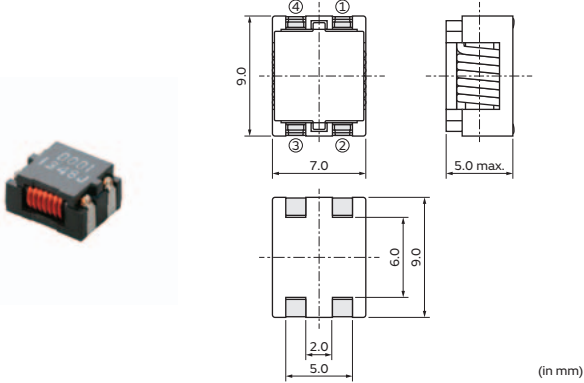

### Packaging

Code	Packaging	Minimum Quantity
=P3	ø330mm Embossed Tape	750

### Equivalent Circuit

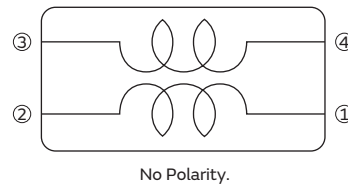

### Rated Value (□: packaging code)

Part Number		Common Mode Impedance at 100MHz	Rated Current	Rated Voltage	Insulation Resistance (Min.)	Withstanding Voltage	DC Resistance
Infotainment	Powertrain/Safety						
<b>1259CM-0001</b> □	—	700Ω(Typ.)	5A	100Vdc	100MΩ	100Vdc	0.01Ω max.

Operating Temp. Range: -40°C to 125°C  
 Operating temperature should include self-temperature rise.

### Z-f characteristics

Impedance-frequency characteristics (1259CM-0001)

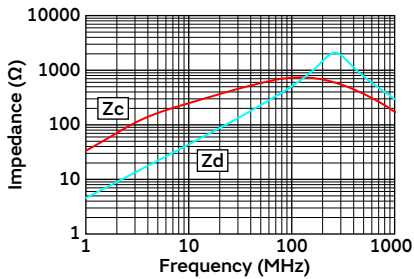

### Common mode transmission characteristics (Typical)

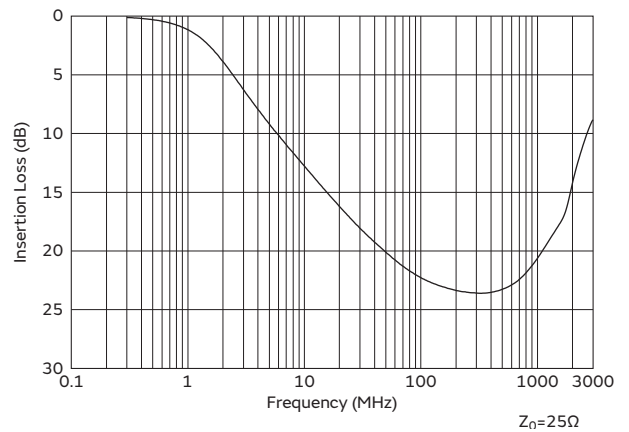

Chip Ferrite Bead  
 Chip EMIFIL  
 Chip Common Mode Choke Coil  
 Block Type EMIFIL  
 Microchip Transformer (Ballun)  
 Inductors for Power Lines  
 Inductors for General Circuits  
 RF Inductors

## Chip Common Mode Choke Coil (DL□ Series) ⚠️Caution/Notice

### ⚠️Caution

#### Rating

Do not use products beyond the rated current and rated voltage as this may create excessive heat and deteriorate the insulation resistance. Be sure to provide an appropriate fail-safe function on your product to prevent a secondary damage occurrence that may be caused by the abnormal function or the failure of our product.

#### Soldering and Mounting

##### 1. Self-heating

Please provide special attention when mounting chip common mode choke coils DLW5 series in close proximity to other products that radiate heat. The heat generated by other products may deteriorate the insulation resistance and cause excessive heat in this component.

##### 2. Mounting Direction

Mount Chip Common Mode Choke Coils in right direction. Wrong direction, which is 90 degrees rotated from right

direction, causes not only open or short circuit but also flames or other serious trouble.

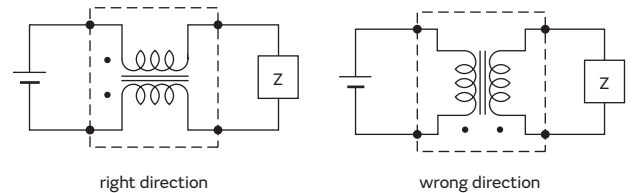

### Notice

#### Storage and Operating Condition

##### 1. Operating Environment

Do not use products in the corrodible atmosphere such as acidic gases, alkaline gases, chlorine, sulfur gases, organic gases. (the sea breeze, Cl<sub>2</sub>, H<sub>2</sub>S, NH<sub>3</sub>, SO<sub>2</sub>, NO<sub>2</sub>, etc)  
Do not use products in the environment close to the organic solvent.

##### 2. Storage Period

The DL series should be used within 12 months. Solderability should be checked if this period is exceeded.

##### 3. Storage Conditions

- (1) Storage temperature: -10 to +40°C  
Relative humidity: 15 to 85%  
Avoid sudden changes in temperature and humidity.
- (2) Do not store products in a chemical atmosphere such as chlorine gas, acid or sulfide gas.

#### Notice (Soldering and Mounting)

##### 1. Soldering

Reliability decreases with improper soldering methods. Please solder by the standard soldering conditions shown in mounting information.

##### 2. Other

Noise suppression levels resulting from Murata's EMI suppression filters EMIFIL may vary, depending on the

circuits and ICs used, type of noise, mounting pattern, mounting location, and other operating conditions. Be sure to check and confirm in advance the noise suppression effect of each filter, in actual circuits, etc. before applying the filter in a commercial-purpose equipment design.

Continued on the following page. ↗

## Chip Common Mode Choke Coil (DL□ Series) ⚠️Caution/Notice

Continued from the preceding page. ↘

### Handling

#### 1. Resin Coating (Except for DLW Series.)

Using resin for coating/molding products may affect the products performance.

So please pay careful attention in selecting resin.

Prior to use, please make the reliability evaluation with the product mounted in your application set.

#### 2. Resin Coating (DLW31S Series)

Do not make any resin coating DLW31S series.

The impedance value may change due to high cure-stress of resin to be used for coating/molding products.

An open circuit issue may occur by mechanical stress caused by the resin, amount/cured shape of resin, or operating condition etc. Some resin contains some impurities or chloride possible to generate chlorine by hydrolysis under some operating condition may cause corrosion of wire of coil, leading to open circuit.

So, please pay your careful attention in selecting resin in case of coating/molding the products with the resin.

#### 3. Resin Coating (Except DLW31S Series)

The impedance value may change due to high cure-stress of resin to be used for coating/molding products. An open circuit issue may occur by mechanical stress caused by the resin, amount/cured shape of resin, or operating condition etc. Some resin contains some impurities or chloride possible to generate chlorine by hydrolysis under some operating condition may cause corrosion of wire of coil, leading to open circuit.

So, please pay your careful attention in selecting resin in case of coating/molding the products with the resin. Prior to use the coating resin, please make sure no reliability issue is observed by evaluating products mounted on your board.

#### 4. Caution for Use (DLW Series)

When you hold products with a tweezer, please hold by the sides. Sharp materials, such as a pair of tweezers, should not touch the winding portion to prevent breaking the wire. Mechanical shock should not be applied to the products mounted on the board to prevent breaking the core.

#### 5. Brushing (DLW21S/31S/32S/43S/43M Series)

When you clean the neighborhood of products such as connector pins, bristles of cleaning brush shall not be touched to the winding portion of this product to prevent the breaking of wire.

#### 6. Handling of a Substrate

After mounting products on a substrate, do not apply any stress to the product caused by bending or twisting to the substrate when cropping the substrate, inserting and removing a connector from the substrate or tightening screw to the substrate. Excessive mechanical stress may cause cracking in the Product.



### Cleaning

Following conditions should be observed when cleaning chip EMI filter.

Do not clean DLW series.

(1) Cleaning temperature: 60°C max. (40°C max. for alcohol type cleaner)

(2) Ultrasonic

Output: 20W/liter max.

Duration: 5 minutes max.

Frequency: 28 to 40kHz

(3) Cleaning agent

The following list of cleaning agents have been tested on the individual components. Evaluation of final assembly should be completed prior to production.

Before cleaning, please contact Murata engineering.

(a) Alcohol cleaning agent

Isopropyl alcohol (IPA)

(b) Aqueous cleaning agent

Pine Alpha ST-100S

(4) Ensure that flux residue is completely removed.

Component should be thoroughly dried after aqueous agent has been removed with deionized water.

Failure and degradation of a product are caused by the cleaning method. When you clean in conditions that are not in mounting information, please contact Murata engineering.

### About Corrosive Gases

Please refrain from use since contact with environments with corrosive gases (sulfur gas [hydrogen sulfide, sulfur dioxide, etc.], chlorine, ammonia, etc.) or oils (cutting oil, silicone oil, etc.) that have come into contact with the previously stated corrosive gas environment will result in deterioration of product quality or an open from deterioration due to corrosion of product electrode, etc.

We will not bear any responsibility for use under these environments.

## Chip Common Mode Choke Coil (PL□ Series) ⚠Caution/Notice

### ⚠Caution

#### Rating

Do not use products beyond the rated current and rated voltage as this may create excessive heat and deteriorate the insulation resistance. Be sure to provide an appropriate

fail-safe function on your product to prevent a secondary damage occurrence that may be caused by the abnormal function or the failure of our product.

#### Soldering and Mounting

##### 1. Self-heating

Please provide special attention when mounting chip common mode choke coils in close proximity to other products that radiate heat. The heat generated by other products may deteriorate the insulation resistance and cause excessive heat in this component.

##### 2. Mounting Direction

Mount Chip Common Mode Choke Coils in right direction.

Wrong direction, which is 90 degrees rotated from right direction, causes not only open or short circuit but also flames or other serious trouble.

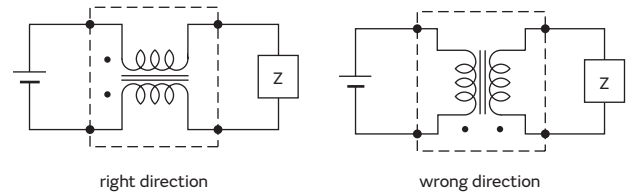

### Notice

#### Storage and Operating Condition

##### 1. Operating Environment

Do not use products in a chemical atmosphere such as chlorine gas, acid or sulfide gas. Do not use products in the environment close to the organic solvent.

##### 2. Storage Period

PLT10H series, PLT5BP series should be used within 12 months. Solderability should be checked if this period is exceeded.

##### 3. Storage Conditions

- (1) Storage temperature: -10 to +40°C  
Relative humidity: 15 to 85%  
Avoid sudden changes in temperature and humidity.
- (2) Do not store products in a chemical atmosphere such as chlorine gas, acid or sulfide gas.

#### Notice (Soldering and Mounting)

##### 1. Soldering

Reliability decreases with improper soldering methods. Please solder by the standard soldering conditions shown in mounting information.

##### 2. Other

Noise suppression levels resulting from Murata's EMI suppression filters EMIFIL may vary, depending on the

circuits and ICs used, type of noise, mounting pattern, mounting location, and other operating conditions. Be sure to check and confirm in advance the noise suppression effect of each filter, in actual circuits, etc. before applying the filter in a commercial-purpose equipment design.

Continued on the following page. ↗

## Chip Common Mode Choke Coil (PL□ Series) ⚠Caution/Notice

Continued from the preceding page. ↘

### Handling

#### Handling of a Substrate

After mounting products on a substrate, do not apply any stress to the product caused by bending or twisting to the substrate when cropping the substrate, inserting and removing a connector from the substrate or tightening screw to the substrate.

Excessive mechanical stress may cause cracking in the Product.

Bending

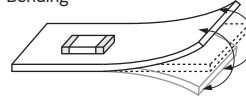

Twisting

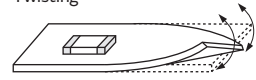

### Cleaning

Do not clean after soldering.

### About Corrosive Gases

Please refrain from use since contact with environments with corrosive gases (sulfur gas [hydrogen sulfide, sulfur dioxide, etc.], chlorine, ammonia, etc.) or oils (cutting oil, silicone oil, etc.) that have come into contact with the previously stated corrosive gas environment will result in deterioration of product quality or an open from deterioration due to corrosion of product electrode, etc. We will not bear any responsibility for use under these environments.

## Chip Common Mode Choke Coil (UCMH□ Series) ⚠️Caution/Notice

### ⚠️Caution

#### Rating

Do not use products beyond the rated current and rated voltage as this may create excessive heat and deteriorate the insulation resistance. Be sure to provide an appropriate fail-safe function on your product to prevent a secondary damage occurrence that may be caused by the abnormal function or the failure of our product.

#### Soldering and Mounting

##### 1. Self-heating

Please provide special attention when mounting this product close to other products that radiate heat. The heat generated by other products may deteriorate the insulation resistance and cause excessive heat in this component.

##### 2. Mounting Direction

Mount Chip Common Mode Choke Coils in right direction. Wrong direction, which is 90 degrees rotated from right direction, causes not only open or short circuit but also flames or other serious trouble.

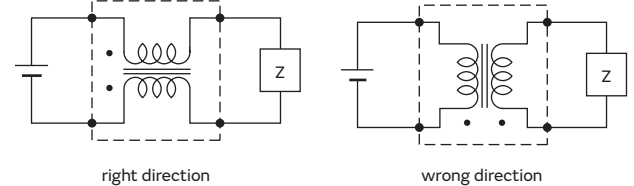

### Notice

#### Handling

##### 1. Resin Coating

The inductance value may change and / or it may affect on the product's performance due to high cure-stress of resin to be used for coating / molding products. So please pay your careful attention when you select resin. In prior to use, please make the reliability evaluation with the product mounted in your application set.

#### Cleaning

Be sure that cleaning does not damage product.

#### About Corrosive Gases

Please refrain from use since contact with environments with corrosive gases (sulfur gas [hydrogen sulfide, sulfur dioxide, etc.], chlorine, ammonia, etc.) or oils (cutting oil, silicone oil, etc.) that have come into contact with the previously stated corrosive gas environment will result in deterioration of product quality or an open from deterioration due to corrosion of product electrode, etc. We will not bear any responsibility for use under these environments.

# Block Type EMIFIL SMD Type BNX02□Series

## Specifications Sheet (with cautions/mounting/packaging)

Infotainment	—
Powertrain/Safety	<a href="https://www.murata.com/products/productdata/8796200861726/QNFH9101.pdf?1571182763000">https://www.murata.com/products/productdata/8796200861726/QNFH9101.pdf?1571182763000</a>

## Appearance/Dimensions

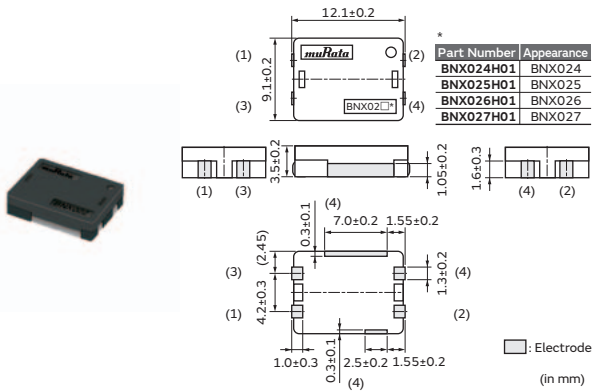

## Packaging

Code	Packaging	Minimum Quantity
L	ø180mm Embossed Tape	400
K	ø330mm Embossed Tape	1500
B	Bulk(Bag)	100

## Equivalent Circuit

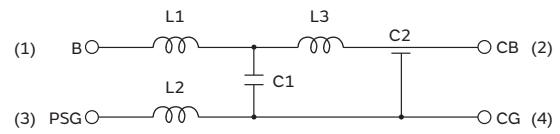

(1)-(4): Terminal Number  
 PSG: Power Supply Ground  
 CG: Circuit Ground  
 CB: Circuit+B

## Rated Value (□: packaging code)

Part Number		Rated Voltage	Withstanding Voltage	Rated Current	Insulation Resistance (min.)	Insertion Loss
Infotainment	Powertrain/Safety					
—	BNX024H01□	50Vdc	125Vdc	20A	100MΩ	100kHz to 1GHz:35dB min. (Line impedance=50Ω)
—	BNX025H01□	25Vdc	62.5Vdc	20A	50MΩ	50kHz to 1GHz:35dB min. (Line impedance=50Ω)
—	BNX026H01□	50Vdc	125Vdc	20A	10MΩ	50kHz to 1GHz:35dB min. (Line impedance=50Ω)
—	BNX027H01□	16Vdc	40Vdc	20A	1MΩ	40kHz to 1GHz:35dB min. (Line impedance=50Ω)

Operating Temp. Range: -55°C to +125°C

## Insertion Loss Characteristics

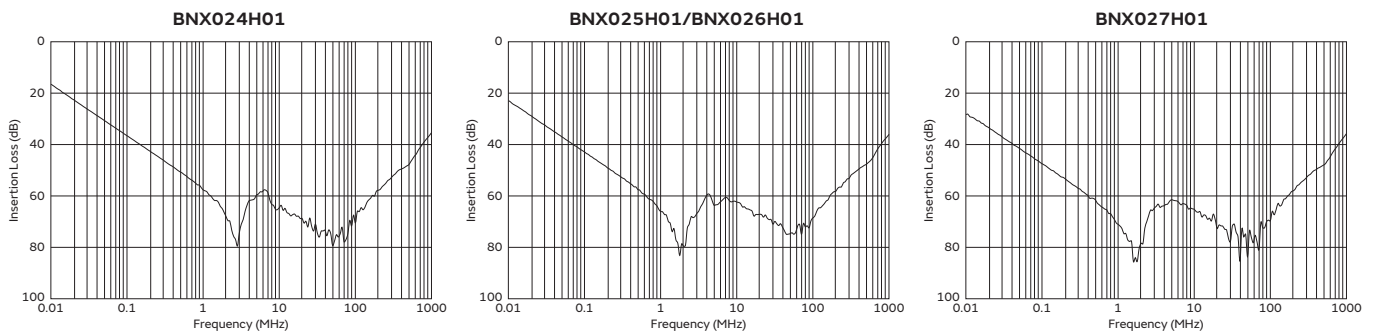

Continued on the following page. ↗



Continued from the preceding page. ↘

## Derating of Rated Current

In operating temperature exceeding +85°C, derating of current is necessary for BNX024H/025H/026H/027H series. Please apply the derating curve shown in chart according to the operating temperature.

Derating of Rated Current

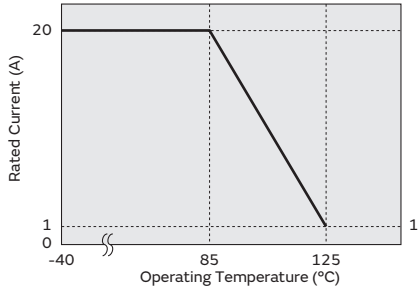

## Block Type EMIFIL SMD Type (BNX Series) ⚠️Caution/Notice

### ⚠️Caution

#### Rating

Do not use products beyond the rated current and rated voltage as this may create excessive heat and deteriorate the insulation resistance.

#### Fail-safe

Be sure to provide an appropriate fail-safe function on your product to prevent a secondary damage occurrence that may be caused by the abnormal function or the failure of our product.

#### ESD

ESD to this product, exceeding condition of IEC61000-4-2 with 30kV, may cause a short circuit along with the creation of fumes or flames.

### Notice

#### Storage and Operating Conditions

- 1. Operating Environment**  
Do not use products in a chemical atmosphere such as chlorine gas, acid or sulfide gas.  
Do not use products in the environment close to the organic solvent.
- 2. Storage Period**  
BNX series should be used within 12 months.  
Solderability should be checked if this period is exceeded.
- 3. Storage Conditions**
  - (1) Storage temperature: -10 to +40°C  
Relative humidity: 15 to 85%  
Avoid sudden changes in temperature and humidity.
  - (2) Do not store products in a chemical atmosphere such as chlorine gas, acid or sulfide gas.

#### Notice (Soldering and Mounting)

- 1. Cleaning**  
Do not clean BNX series (SMD Type).
- 2. Soldering**  
Reliability decreases with improper soldering methods.  
Please solder by the standard soldering conditions shown in mounting information.
- 3. Other**  
Noise suppression levels resulting from Murata's EMI suppression filters EMIFIL may vary, depending on the circuits and ICs used, type of noise, mounting pattern, mounting location, and other operating conditions. Be sure to check and confirm in advance the noise suppression effect of each filter, in actual circuits, etc. before applying the filter in a commercial-purpose equipment design.

Continued on the following page. ↗

Chip Ferrite Bead

Chip EMIFIL

Chip Common Mode Choke Coil

Block Type EMIFIL

Microchip Transformer (Balun)

Inductors for Power Lines

Inductors for General Circuits

RF Inductors

## Block Type EMIFIL SMD Type (BNX Series) ⚠Caution/Notice

Continued from the preceding page. ↘

### Handling

#### 1. Resin Coating

Using resin for coating/molding products may affect the products performance.

So please pay careful attention in selecting resin.

Prior to use, please make the reliability evaluation with the product mounted in your application set.

#### 2. Handling of a Substrate (for BNX02□)

After mounting products on a substrate, do not apply any stress to the product caused by bending or twisting to the substrate when cropping the substrate, inserting and

removing a connector from the substrate or tightening screw to the substrate.

Excessive mechanical stress may cause cracking in the Product.

Bending

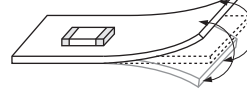

Twisting

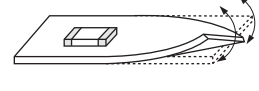

### About Corrosive Gases

Please refrain from use since contact with environments with corrosive gases (sulfur gas [hydrogen sulfide, sulfur dioxide, etc.], chlorine, ammonia, etc.) or oils (cutting oil, silicone oil, etc.) that have come into contact with the previously stated corrosive gas environment will result in deterioration of product quality or an open from deterioration due to corrosion of product electrode, etc. We will not bear any responsibility for use under these environments.

# Block Type EMIFIL Lead Type BNX012 Series

## Specifications Sheet (with cautions/mounting/packaging)

Infotainment	—
Powertrain/Safety	<a href="https://www.murata.com/products/productdata/8796200894494/QNFH9102.pdf?1561681112000">https://www.murata.com/products/productdata/8796200894494/QNFH9102.pdf?1561681112000</a>

## Appearance/Dimensions

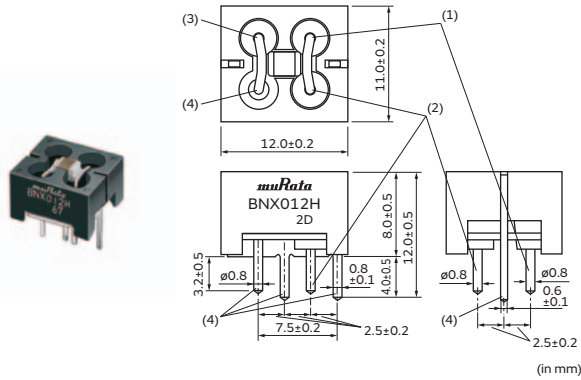

## Packaging

Code	Packaging	Minimum Quantity
—	Box	150

## Equivalent Circuit

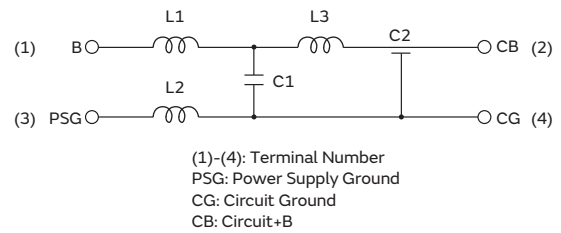

## Rated Value (□: packaging code)

Part Number		Rated Voltage	Withstanding Voltage	Rated Current	Insulation Resistance (min.)	Insertion Loss
Infotainment	Powertrain/Safety					
—	<b>BNX012H01</b>	50Vdc	125Vdc	15A	500MΩ	1MHz to 1GHz:40dB min. (Line impedance=50Ω)

Operating Temp. Range: -55°C to +125°C

## Insertion Loss Characteristics

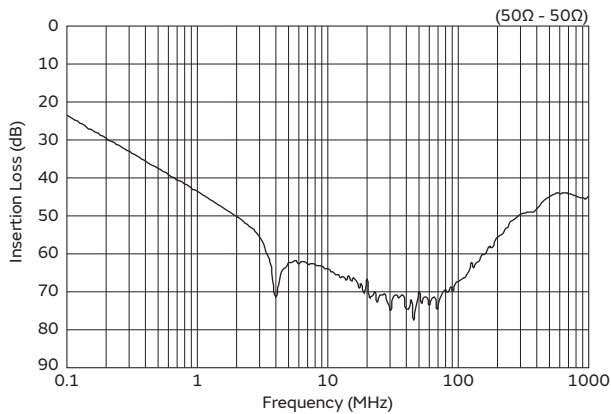

Continued on the following page. ↗

Chip Ferrite Bead  
 Chip EMIFIL  
 Chip Common Mode Choke Coil  
 Block Type EMIFIL  
 Microchip Transformer (Balun)  
 Inductors for Power Lines  
 Inductors for General Circuits  
 RF Inductors

Continued from the preceding page. ↘

## Derating of Rated current

### ● Rating

In operating temperatures exceeding +85°C, derating of current is necessary for BNX012H series. Please apply the derating curve shown in chart according to the operating temperature.

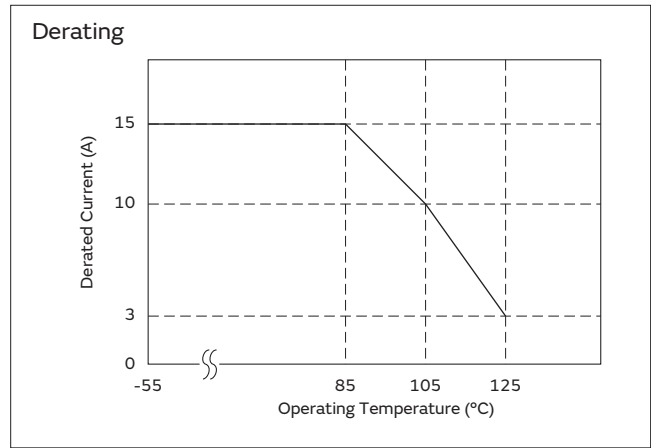

### ● Connecting ± Power Line

In case of using ± power line, please connect to each terminal as shown.

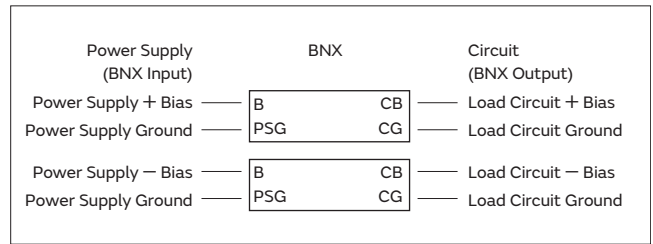

## Block Type EMIFIL Lead Type (BNX Series) ⚠Caution/Notice

### ⚠Caution

#### Rating

Do not use products beyond the rated current and rated voltage as this may create excessive heat and deteriorate the insulation resistance.

#### Fail-safe

Be sure to provide an appropriate fail-safe function on your product to prevent a secondary damage occurrence that may be caused by the abnormal function or the failure of our product.

### Notice

#### Storage and Operating Conditions

##### 1. Operating Environment

- (1) Do not use products in a chemical atmosphere such as chlorine gas, acid or sulfide gas.
- (2) Do not use products near water, oil or organic solvents.

##### 2. Storage Period

- BNX Series should be used within 12 months.  
Solderability should be checked if this period is exceeded.

##### 3. Storage Conditions

- (1) Storage temperature: -10 to +40°C  
Relative humidity: 15 to 85%  
Avoid sudden changes in temperature and humidity.
- (2) Do not store products in a chemical atmosphere such as chlorine gas, acid or sulfide gas.

#### Notice (Soldering and Mounting)

##### 1. Soldering

- Reliability decreases with improper soldering methods.  
Please solder by the standard soldering conditions shown in mounting information.

##### 2. Other

- Noise suppression levels resulting from Murata's EMI suppression filters "EMIFIL" may vary, depending on the

circuits and ICs used, type of noise, mounting pattern, lead wire length, mounting location, and other operating conditions. Be sure to check and confirm in advance the noise suppression effect of each filter, in actual circuits, etc. before applying the filter in a commercial-purpose equipment design.

#### Notice (Appearance)

Although some part of the product surface seems to be white in some cases, do not become alarmed as it is the result of a waxing process for humidity resistance improvement. This wax does not impede mechanical performance, electrical performance, or reliability of the product.

Continued on the following page. ↗

## Block Type EMIFIL Lead Type (BNX Series) ⚠Caution/Notice

Continued from the preceding page. ↘

### Cleaning

Clean the block Type EMIFIL (Lead Type) in the following conditions.

- (1) Cleaning temperature should be limited to 60°C max. (40°C max for alcohol type cleaner).
- (2) Ultrasonic cleaning should comply with the following conditions, avoiding the resonance phenomenon at the mounted products and P.C.B.  
Power: 20W/liter max.  
Frequency: 28 to 40kHz  
Time: 5 min. max.
- (3) Cleaner
  - (a) Alcohol type cleaner  
Isopropyl alcohol (IPA)
  - (b) Aqueous agent  
Pine Alpha ST-100S

- (4) There should be no residual flux or residual cleaner left after cleaning.  
In the case of using aqueous agent, products should be dried completely after rinsing with de-ionized water in order to remove the cleaner.
- (5) The surface of products may become dirty after cleaning, but there is no deterioration on mechanical, electrical characteristics and reliability.
- (6) Other cleaning: Please contact us.

### About Corrosive Gases

Please refrain from use since contact with environments with corrosive gases (sulfur gas [hydrogen sulfide, sulfur dioxide, etc.], chlorine, ammonia, etc.) or oils (cutting oil, silicone oil, etc.) that have come into contact with the previously stated corrosive gas environment will result in

deterioration of product quality or an open from deterioration due to corrosion of product electrode, etc. We will not bear any responsibility for use under these environments.

## ● Part Numbering

### Micro Chip Transformer for Automotive

(Part Number) 

DX	W	21	B	Z	75	11	S	L
①	②	③	④	⑤	⑥	⑦	⑧	⑨

#### ① Product ID

Product ID	
DX	Micro Chip Transformer

#### ② Structure

Code	Structure
W	Winding Type

#### ③ Dimensions (LxW)

Code	Dimensions (LxW)	Size Code (inch)
21	2.0x1.2mm	0805

#### ④ Type of Transformer

Code	Type of Transformer
B	Balun

#### ⑤ Category

Code	Category	
Z	For Automotive	Infotainment

#### ⑥ Port Impedance

Code	Port Impedance
75	75Ω

#### ⑦ Characteristics

Code	Impedance Ratio
11	one to one

#### ⑧ Rough Frequency Range

Code	Rough Frequency Range
T	50MHz to 870MHz
S	950MHz to 2150MHz

#### ⑨ Packaging

Code	Packaging
K	Embossed Taping (ø330mm Reel)
L	Embossed Taping (ø180mm Reel)
B	Bulk



# Microchip Transformer (Balun)

## DXW21B Series 0805/2012 (inch/mm)

### Specifications Sheet (with cautions/mounting/packaging)

Infotainment	<a href="https://www.murata.com/products/productdata/8796209938462/QFLC9113.pdf?1608273989000">https://www.murata.com/products/productdata/8796209938462/QFLC9113.pdf?1608273989000</a>
Powertrain/Safety	—

### Appearance/Dimensions

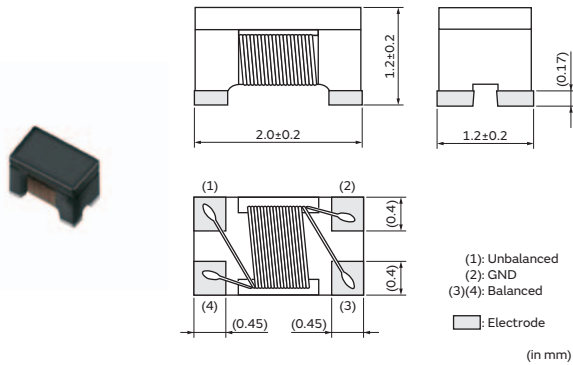

### Packaging

Code	Packaging	Minimum Quantity
L	ø180mm Embossed Tape	2000
K	ø330mm Embossed Tape	10000
B	Bulk(Bag)	500

### Equivalent Circuit

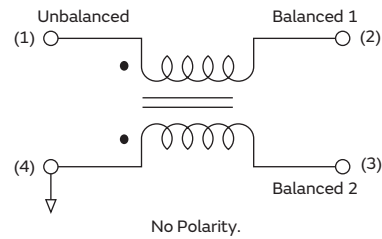

### Rated Value (□: packaging code)

Part Number		Frequency Range	Port Impedance	Insertion Loss at Freq. Range (max.)	CMRR at Freq. Range (min.)	Rated Power
Infotainment	Powertrain/Safety					
DXW21BZ7511S□	—	1 to 1.5GHz	75Ω - 75Ω	1.4dB	20dB	27dBm
DXW21BZ7511T□	—	50 to 870MHz	75Ω - 75Ω	1.0dB	20dB	27dBm

Operating Temp. Range: -40°C to +105°C Only for reflow soldering.

### Insertion Loss Characteristics

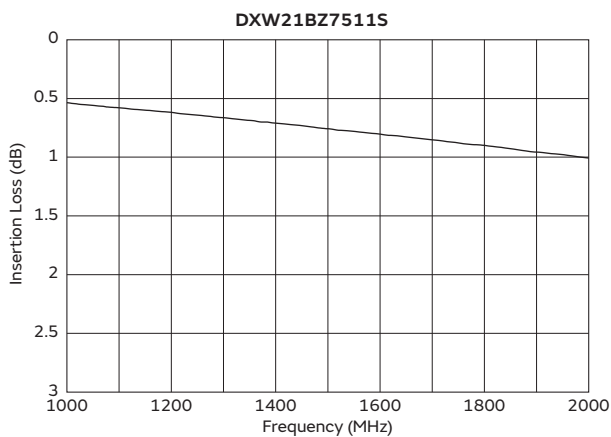

### CMRR Characteristics

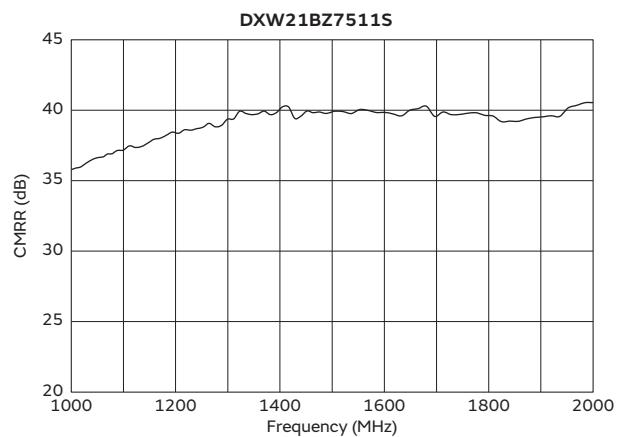

Continued on the following page. ↗

Continued from the preceding page. ↘

### Insertion Loss Characteristics

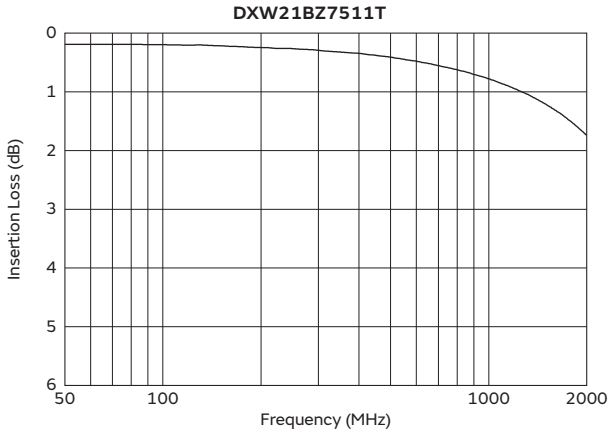

### CMRR Characteristics

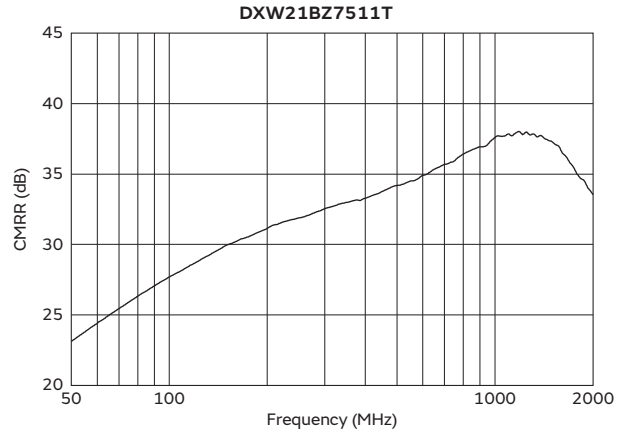

Chip Ferrite Bead

Chip EMIFIL

Chip Common Mode Choke Coil

Block Type EMIFIL

Microchip Transformer (Balun)

Inductors for Power Lines

Inductors for General Circuits

RF Inductors

## Microchip Transformer (Balun) (DX□ Series) ⚠️Caution/Notice

### ⚠️Caution

#### Rating

Do not use products beyond the rated current and rated voltage as this may create excessive heat and deteriorate the insulation resistance.

#### Soldering and Mounting

##### 1. Self-heating

Please provide special attention when mounting chip Micro Chip Transformer (DXW) series in close proximity to other products that radiate heat. The heat generated by other products may deteriorate the insulation resistance and cause excessive heat in this component.

##### 2. Mounting Direction

Mount Micro Chip Transformer in right direction. Wrong direction, which is 90 degree rotated from right direction,

the characteristics does not come out as Micro Chip Transformer or causes not only open or short circuit but also flames or other serious trouble.

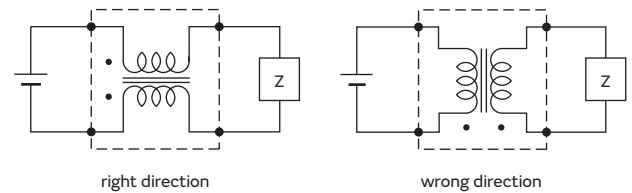

### Notice

#### Storage and Operating Conditions

##### 1. Operating Environment

Do not use products in a chemical atmosphere such as chlorine gas, acid or sulfide gas.

##### 2. Storage Period

DXW series should be used within 12 months. Solderability should be checked if this period is exceeded.

##### 3. Storage Conditions

(1) Storage temperature: -10 to +40 degree C

Relative humidity: 15 to 85%

Avoid sudden changes in temperature and humidity.

(2) Do not store products in a chemical atmosphere such as chlorine gas, acid or sulfide gas.

#### Handling

##### 1. Resin Coating

The impedance value may change due to high cure-stress of resin to be used for coating/molding products. An open circuit issue may occur by mechanical stress caused by the resin, amount/cured shape of resin, or operating condition etc. Some resin contains some impurities or chloride possible to generate chlorine by hydrolysis under some operating condition may cause corrosion of wire of coil, leading to open circuit. So, please pay your careful attention in selecting resin in case of coating/molding the products with the resin. Prior to use the coating resin, please make sure no reliability issue is observed by evaluating products mounted on your board.

##### 2. Handling of a Substrate

After mounting products on a substrate, do not apply any stress to the product caused by bending or twisting to the substrate when cropping the substrate, inserting and removing a connector from the substrate or tightening screw to the substrate.

Excessive mechanical stress may cause cracking in the Product.

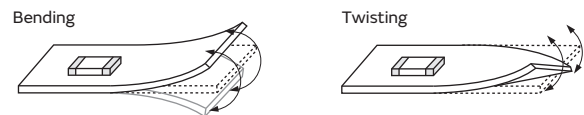

#### Cleaning

Do not clean.

Continued on the following page. ↗

## Microchip Transformer (Balun) (DX□ Series) ⚠️Caution/Notice

Continued from the preceding page. ↘

### About Corrosive Gases

---

Please refrain from use since contact with environments with corrosive gases (sulfur gas [hydrogen sulfide, sulfur dioxide, etc.], chlorine, ammonia, etc.) or oils (cutting oil, silicone oil, etc.) that have come into contact with the previously stated corrosive gas environment will result in deterioration of product quality or an open from deterioration due to corrosion of product electrode, etc. We will not bear any responsibility for use under these environments.

# Product Guide

Structure	Series	Applications	Size Code in mm (in inch)	Inductance Range		Rated Current Range			
				Min.	Max.	Min.	Max.		
Wire Wound Ferrite Core Type	DEM8045C_Z	p230		8080 (3131)	1.5μH	47μH	2.1A	11.2A	
	LQH2MPZ_GR	p201		2016 (0806)	330nH	82μH	210mA	2.2A	
	LQH2HPZ_DR	p203		2520 (1008)	470nH	22μH	270mA	1.67A	
	LQH2HPZ_GR	p205		2520 (1008)	470nH	22μH	460mA	2.9A	
	LQH2HPZ_JR	p207		2520 (1008)	470nH	22μH	540mA	3.5A	
	LQH3NPZ_GR	p209		3030 (1212)	470nH	47μH	460mA	2.82A	
	LQH3NPZ_JR	p211		3030 (1212)	680nH	47μH	570mA	2.86A	
	LQH3NPH_ME	p213		3030 (1212)	1μH	100μH	430mA	3A	
	LQH3NPZ_ME	p213		3030 (1212)	1μH	100μH	430mA	3A	
	LQH32PH_NO	p215		3225 (1210)	470nH	10μH	750mA	3.4A	
	LQH32PZ_NO	p215		3225 (1210)	470nH	120μH	200mA	3.4A	
	LQH32PH_NC	p217		3225 (1210)	470nH	22μH	650mA	4.4A	
	LQH32PZ_NC	p217		3225 (1210)	470nH	22μH	650mA	4.4A	
	LQH32DZ_23	p219		3225 (1210)	1μH	470μH	60mA	800mA	
	LQH32DZ_53	p220		3225 (1210)	1μH	100μH	100mA	1A	
	LQH32CH_23	p221		3225 (1210)	1μH	22μH	250mA	800mA	
	LQH32CH_33	p222		3225 (1210)	150nH	10μH	450mA	1.45A	
	LQH32CH_53	p223		3225 (1210)	1μH	22μH	250mA	1A	
	LQH43PH_26	p224		4532 (1812)	1μH	220μH	240mA	3.4A	
	LQH43PZ_26	p224		4532 (1812)	1μH	220μH	240mA	3.4A	
	LQH44PH_PR	p226		4040 (1515)	1μH	220μH	330mA	4.3A	
	LQH5BPH_TO	p228		4040 (1515)	470nH	47μH	850mA	7.7A	
	LQH5BPZ_TO	p228		4040 (1515)	470nH	22μH	1.4A	7.7A	
	LQW21FT_OH	p266		2012 (0805)	470nH	2μH	450mA	1.1A	
	LQW32FT_OH	p268		3225 (1210)	2.2μH	47μH	500mA	1A	
	Wire Wound Metal Alloy Core Type	DFE201612P_D	p191		2016 (0806)	150nH	2.2μH	1.7A	6.2A
		DFE252012P_D	p195		2520 (1008)	330nH	10μH	1.1A	6A
		DFE2HCAH_J0	p197		2520 (1008)	330nH	2.2μH	2.5A	5.8A
		DFE2MCAH_J0	p193		2016 (0806)	150nH	2.2μH	1.7A	6.1A
		DFE322520F_D	p199		3225 (1210)	1μH	4.7μH	3.4A	7.5A
Multilayer Type	LQM18DH_70	p240		1608 (0603)	6.8μH	47μH	180mA	330mA	
	LQM18DZ_70	p240		1608 (0603)	6.8μH	47μH	180mA	330mA	
	LQM18PH_FR	p236		1608 (0603)	220nH	4.7μH	620mA	1.5A	
	LQM18PZ_CH	p232		1608 (0603)	1μH	2.5μH	750mA	950mA	
	LQM18PZ_DH	p234		1608 (0603)	2.2μH	2.2μH	650mA	650mA	
	LQM18PZ_FH	p238		1608 (0603)	2.2μH	2.2μH	700mA	700mA	
	LQM21DH_70	p250		2012 (0805)	10μH	100μH	160mA	300mA	
	LQM21PH_G0	p244		2012 (0805)	470nH	540nH	1.6A	2.15A	
	LQM21PH_GC	p246		2012 (0805)	1μH	2.2μH	800mA	1A	
	LQM21PZ_C0	p242		2012 (0805)	470nH	2.2μH	600mA	1.1A	
	LQM21PZ_G0	p244		2012 (0805)	470nH	3.3μH	800mA	1.3A	
	LQM21PZ_GC	p246		2012 (0805)	1μH	2.2μH	800mA	900mA	
	LQM21PZ_GR	p248		2012 (0805)	1μH	4.7μH	800mA	1.3A	
	LQM2HPZ_E0	p256		2520 (1008)	560nH	560nH	1.5A	1.5A	
	LQM2HPZ_G0	p258		2520 (1008)	470nH	4.7μH	1.1A	1.8A	
	LQM2HPZ_GC	p260		2520 (1008)	1μH	4.7μH	800mA	1.5A	
	LQM2HPZ_GS	p262		2520 (1008)	2.2μH	4.7μH	1A	1.1A	
	LQM2HPZ_J0	p264		2520 (1008)	1μH	3.3μH	1A	1.5A	
	LQM2MPZ_G0	p252		2016 (0806)	470nH	470nH	1.1A	1.6A	
	LQM2MPZ_JH	p254		2016 (0806)	100nH	100nH	4A	4A	

Continued on the following page. ↗

	Structure	Series	Applications	Size Code in mm (in inch)	Inductance Range		Rated Current Range		
					Min.	Max.	Min.	Max.	
Inductors for General Circuits	Wire Wound Ferrite Core Type	HEAWS p281	<a href="#">Info-tainment</a>	Over 10 mm Square	3.3μH	10μH	5A	8A	
		LQH31HZ_03 p275	<a href="#">Info-tainment</a>	3216 (1206)	54nH	880nH	180mA	920mA	
		LQH32NH_23 p276	<a href="#">Info-tainment</a>	<a href="#">Power-train</a>	3225 (1210)	1μH	560μH	40mA	780mA
		LQH32NZ_23 p276	<a href="#">Info-tainment</a>		3225 (1210)	1μH	470μH	45mA	445mA
		LQH43NH_03 p278	<a href="#">Info-tainment</a>	<a href="#">Power-train</a>	4532 (1812)	1μH	2200μH	30mA	1.3A
		LQH43NZ_03 p278	<a href="#">Info-tainment</a>		4532 (1812)	1μH	2400μH	25mA	500mA
		5CCEG p282	<a href="#">Info-tainment</a>		5mm Square	Please refer to the product detail page.			
		FSDVA p283	<a href="#">Info-tainment</a>		5mm Square				
RF Inductors	Film Type	LQP03TN_Z2 p301	<a href="#">Info-tainment</a>	0603 (0201)	0.6nH	120nH	80mA	850mA	
	Wire Wound Ferrite Core Type	LQW15CN_0Z p332	<a href="#">Info-tainment</a>	1005 (0402)	18nH	200nH	390mA	1.4A	
		LQW15CN_1Z p334	<a href="#">Info-tainment</a>	1005 (0402)	20nH	560nH	300mA	2.2A	
		LQW18CN_0Z p336	<a href="#">Info-tainment</a>	1608 (0603)	4.9nH	650nH	430mA	2.6A	
		LQW15AN_0Z p305	<a href="#">Info-tainment</a>	1005 (0402)	1.5nH	120nH	110mA	1A	
	Wire Wound Non-Magnetic Core Type	LQW15AN_1Z p311	<a href="#">Info-tainment</a>	1005 (0402)	1.3nH	8.4nH	640mA	1.2A	
		LQW15AN_8Z p313	<a href="#">Info-tainment</a>	1005 (0402)	1.3nH	75nH	320mA	3.15A	
		LQW18AN_0Z p320	<a href="#">Info-tainment</a>	1608 (0603)	2.2nH	470nH	75mA	850mA	
		LQW18AN_1Z p323	<a href="#">Info-tainment</a>	1608 (0603)	2.2nH	33nH	550mA	1.4A	
		LQW18AN_8Z p325	<a href="#">Info-tainment</a>	1608 (0603)	2.2nH	390nH	190mA	3.2A	
		LQW18AS_0Z p329	<a href="#">Info-tainment</a>	1608 (0603)	1.6nH	390nH	100mA	700mA	
		Multilayer Type	LQG15HH_02 p289	<a href="#">Info-tainment</a>	<a href="#">Power-train</a>	1005 (0402)	1nH	270nH	110mA
	LQG15HZ_02 p289		<a href="#">Info-tainment</a>		1005 (0402)	1nH	270nH	110mA	1A
	LQG15WH_02 p293		<a href="#">Info-tainment</a>	<a href="#">Power-train</a>	1005 (0402)	0.7nH	150nH	110mA	1.2A
	LQG15WZ_02 p293		<a href="#">Info-tainment</a>		1005 (0402)	0.7nH	150nH	110mA	1.2A
	LQG18HH_00 p299		<a href="#">Info-tainment</a>	<a href="#">Power-train</a>	1608 (0603)	1.2nH	270nH	200mA	1.1A

## ● Part Numbering

### Inductors for Power Lines for Automotive

(Part Number) 

LQ	M	21	P	Z	R54	M	G	0	D
①	②	③	④	⑤	⑥	⑦	⑧	⑨	⑩

#### ① Product ID

Product ID	
LQ	Chip Inductors (Chip Coils)

#### ② Structure

Code	Structure
H	Wire Wound Type (Ferrite Core)
M	Multilayer Type (Ferrite Core)
W	Wire Wound Type (Ferrite Core)

#### ③ Dimensions (LxW)

Code	Nominal Dimensions (LxW)	Size Code (in inch)
18	1.6x0.8mm	0603
21	2.0x1.25mm or 2.0x1.2mm	0805
2M	2.0x1.6mm	0806
2H	2.5x2.0mm	1008
3N	3.0x3.0mm	1212
32	3.2x2.5mm	1210
43	4.5x3.2mm	1812
44	4.0x4.0mm	1515
5B	5.0x5.0mm	2020

#### ④ Applications and Characteristics

Code	Series	Applications and Characteristics
D	LQH	for Choke
C		for Choke (Coating Type)
P	LQM/LQH	for Power Line
F	LQW	for Choke

#### ⑤ Category

Code	Series	Category	
Z	LQH/LQM	Automotive	Infotainment
H			Powertrain/Safety
T	LQW	Standard Type	

#### ⑥ Inductance

Expressed by three-digit alphanumerics. The unit is micro-henry (μH). The first and second figures are significant digits, and the third figure expresses the number of zeros that follow the two figures. If there is a decimal point, it is expressed by the capital letter "R." In this case, all figures are significant digits. If inductance is less than 0.1μH, the inductance code is expressed by a combination of two figures and the capital letter "N," and the unit of inductance is nano-henry (nH). The capital letter "N" indicates the unit of "nH," and also expresses a decimal point. In this case, all figures are significant digits. For those products whose inductance values are specified using three designated digits, these values may be indicated using the closest two digits instead.

#### ⑦ Inductance Tolerance

Code	Inductance Tolerance
K	±10%
M	±20%
N	±30%

#### ⑧ Features (Except for LQH□□P/LQM□□P)

Code	Features	Series
0	Standard Type	LQW
2	Standard Type	LQH32C/32D
3	Low DC Resistance	
5	Low Profile Type	LQM21D
7	High Current Type	

#### ⑨ Thickness

(LQH□□P/LQM□□P Only • Except for LQH43P)

Code	Nominal Dimensions (T)
C	0.5mm
D	0.6mm
E	0.7mm
F	0.8mm
G	0.9mm
J	1.1mm
M	1.4mm
N	1.55mm
T	2.0mm

#### ⑩ Electrode (Except for LQH□□P/LQM□□P)

•Lead (Pb) Free

Code	Electrode	Series
0	Sn	LQM
3	LF Solder	LQH
H	Automotive Powertrain/Safety	LQW

#### ⑪ Specification

(LQH□□P/LQM□□P Only • Except for LQH43P)

Code	Specification
O/S	Standard Type
C	Good Bias Current Characteristics Type
H/E	High Spec Type (Low DC Resistance; Good Bias Current Characteristics Type)
R	Low DC Resistance Type

Continued on the following page. ↗

Continued from the preceding page. ↘

⑨ Thickness (LQH43P Only)

Code	Dimensions (T)
26	2.6mm

⑩ Packaging

Code	Packaging
K	Embossed Taping (ø330mm Reel)
L	Embossed Taping (ø180mm Reel)
B	Bulk
D	Paper Taping (ø180mm Reel)

Chip Ferrite Bead

Chip EMIFIL

Chip Common Mode Choke Coil

Block Type EMIFIL

Microchip Transformer (Balun)

Inductors for Power Lines

Inductors for General Circuits

RF Inductors



## Inductors for Power Lines

# DFE201612P\_D Series 0806 (2016) inch (mm)

### Specifications Sheet (with cautions/mounting/packaging)

Infotainment	<a href="https://search.murata.co.jp/Ceramy/image/img/P02/J(E)TE243A-9101.pdf">https://search.murata.co.jp/Ceramy/image/img/P02/J(E)TE243A-9101.pdf</a>
Powertrain/Safety	—

#### Appearance/Dimensions

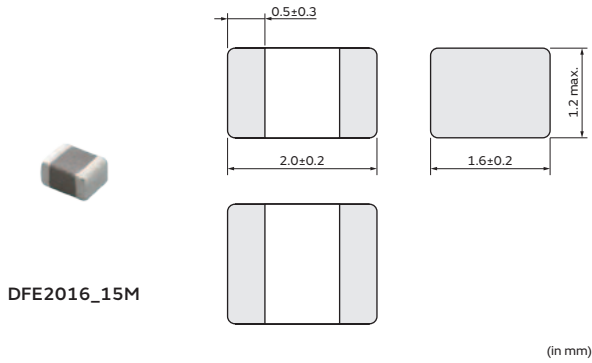

#### Packaging

Code	Packaging	Minimum Quantity
=P2	ø180mm Embossed Taping	3000

#### Appearance/Dimensions

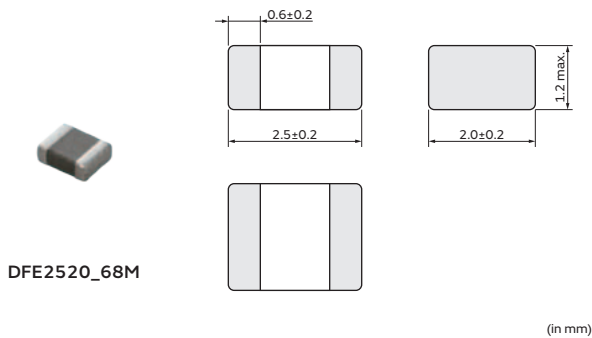

#### Packaging

Code	Packaging	Minimum Quantity
=P2	ø180mm Embossed Taping	3000

### Rated Value (□: packaging code)

Part Number		Inductance	Inductance Test Frequency	Rated Current (Isat)*	Rated Current (Itemp)*	Max. of DC Resistance
Infotainment	Powertrain/Safety					
DFE201612PD-R15M□	—	0.15μH ±20%	1MHz	6200mA	5200mA	0.018Ω
DFE201612PD-R24M□	—	0.24μH ±20%	1MHz	5000mA	4000mA	0.022Ω
DFE201612PD-R33M□	—	0.33μH ±20%	1MHz	4500mA	3800mA	0.026Ω
DFE201612PD-R47M□	—	0.47μH ±20%	1MHz	3800mA	3200mA	0.032Ω
DFE252012PD-R68M□	—	0.68μH ±20%	1MHz	4300mA	3500mA	0.037Ω
DFE201612PD-1R0M□	—	1μH ±20%	1MHz	2700mA	2200mA	0.06Ω
DFE201612PD-1R5M□	—	1.5μH ±20%	1MHz	2000mA	1700mA	0.098Ω

Operating temp.range (Self-temp.rise included): -40 to 125°C

Absolute maximum voltage: 10Vdc

Inductance:

Measured with an LCR meter 4284A (Keysight) or equivalent.

RDC:

Measured with a Resistance Hitester 3541 (HIOKI) or equivalent.

Only for reflow soldering

\*Isat: Rated Current based on Inductance change

\*Itemp: Rated Current based on Temperature rise

Rated current (Isat) is specified when the decrease of the initial inductance value at 30%.

Rated current (Itemp) is specified when temperature of the inductor is raised 40°C by DC current.

Class of Magnetic Shield: Metal Alloy

Continued on the following page. ↗

Continued from the preceding page. ↘

Part Number		Inductance	Inductance Test Frequency	Rated Current (Isat)*	Rated Current (Itemp)*	Max. of DC Resistance
Infotainment	Powertrain/Safety					
DFE201612PD-2R2M□	—	2.2μH ±20%	1MHz	1700mA	1200mA	0.172Ω

Operating temp.range (Self-temp.rise included): -40 to 125°C  
 Absolute maximum voltage: 10Vdc

Inductance:

Measured with an LCR meter 4284A (Keysight) or equivalent.

RDC:

Measured with a Resistance Hitester 3541 (HIOKI) or equivalent.

Only for reflow soldering

\*Isat: Rated Current based on Inductance change

\*Itemp: Rated Current based on Temperature rise

Rated current (Isat) is specified when the decrease of the initial inductance value at 30%.

Rated current (Itemp) is specified when temperature of the inductor is raised 40°C by DC current.

Class of Magnetic Shield: Metal Alloy

### Inductance-Frequency Characteristics (Typ.)

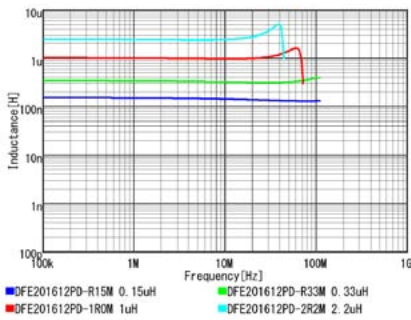

### Inductance-Current Characteristics (Typ.)

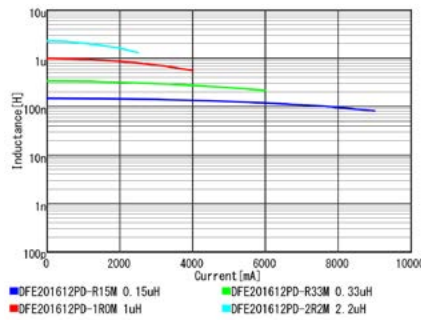

### Temperature Rise Characteristics (Typ.)

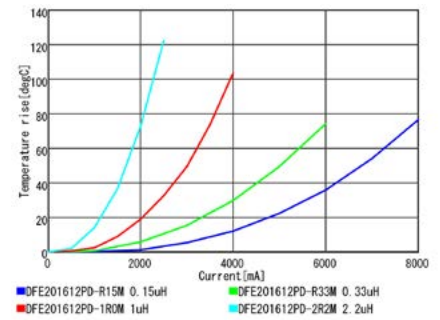

Chip Ferrite Bead

Chip EMIFIL

Chip Common Mode Choke Coil

Block Type EMIFIL

Microchip Transformer (Balun)

Inductors for Power Lines

Inductors for General Circuits

RF Inductors

# Inductors for Power Lines

## DFE2MCAH\_J0 Series 0806 (2016) inch (mm)

### Specifications Sheet (with cautions/mounting/packaging)

Infotainment	—
Powertrain/Safety	<a href="https://search.murata.co.jp/Ceramy/image/img/P02/JETE243A-9107.pdf">https://search.murata.co.jp/Ceramy/image/img/P02/JETE243A-9107.pdf</a>

### Appearance/Dimensions

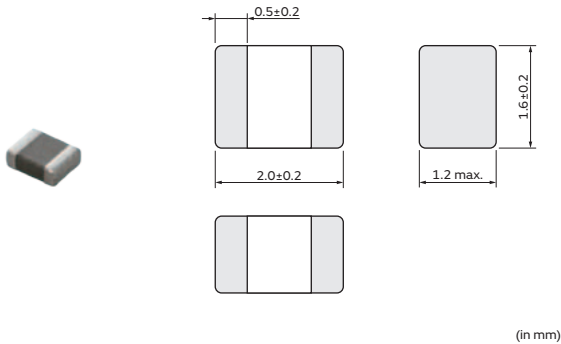

### Packaging

Code	Packaging	Minimum Quantity
L	ø180mm Embossed Taping	3000

### Rated Value (□: packaging code)

Part Number		Inductance	Inductance Test Frequency	Rated Current (Isat)*	Rated Current (Itemp)*	Max. of DC Resistance
Infotainment	Powertrain/Safety					
—	DFE2MCAHR15MJ0□	0.15μH ±20%	1MHz	6.1A	4.8A	0.021Ω
—	DFE2MCAHR24MJ0□	0.24μH ±20%	1MHz	5A	4.2A	0.025Ω
—	DFE2MCAHR33MJ0□	0.33μH ±20%	1MHz	4.2A	3.9A	0.029Ω
—	DFE2MCAHR47MJ0□	0.47μH ±20%	1MHz	3.6A	3.5A	0.033Ω
—	DFE2MCAHR68MJ0□	0.68μH ±20%	1MHz	3.1A	3A	0.042Ω
—	DFE2MCAH1R0MJ0□	1μH ±20%	1MHz	2.5A	2.4A	0.068Ω
—	DFE2MCAH1R5MJ0□	1.5μH ±20%	1MHz	2.1A	1.8A	0.109Ω
—	DFE2MCAH2R2MJ0□	2.2μH ±20%	1MHz	1.7A	1.4A	0.169Ω

Operating temp.range (Self-temp.rise included): -40 to 150°C

Operating temp.range (Self-temp.rise not included): -40 to 110°C

Class of Magnetic Shield: Metal Alloy

Only for reflow soldering

\*Isat: Rated Current based on Inductance change

\*Itemp: Rated Current based on Temperature rise

Rated current (Isat) is specified when the decrease of the initial inductance value at 30%. Rated current (Itemp) is specified when temperature of the inductor is raised 40°C by DC current.

Keep the temperature (ambient temperature plus self-generation of heat) under 150°C. It can be considered for use with DCDC converters with a maximum voltage of 40 V or less.

### Inductance-Frequency Characteristics (Typ.)

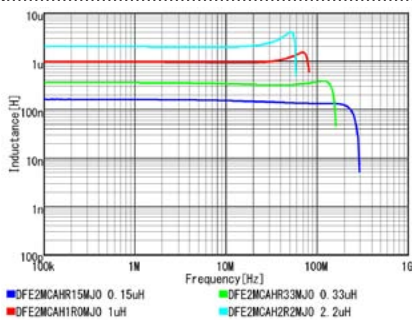

### Inductance-Current Characteristics (Typ.)

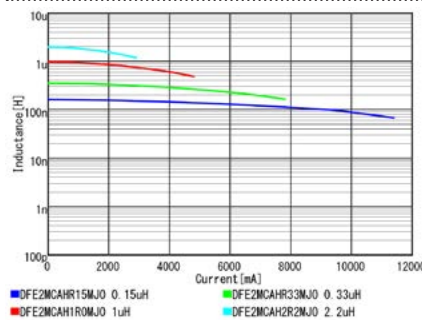

### Temperature Rise Characteristics (Typ.)

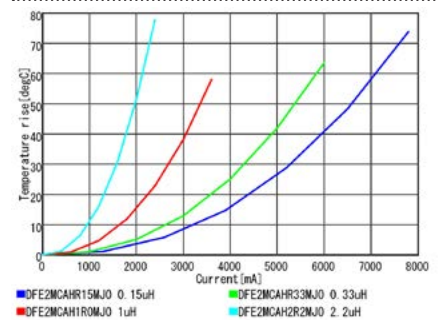

Continued on the following page. ↗

Continued from the preceding page. ↘

### Notice(Rating)

Max. current (DC, AC) as function of product temperature  
(derating curve).

Derating of Rated Current

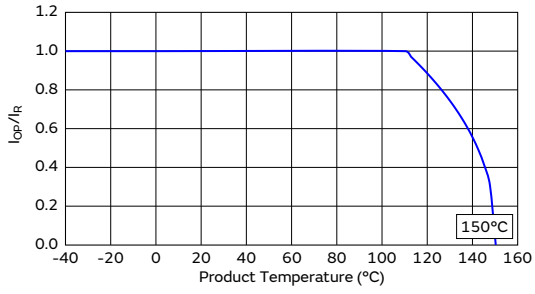

Chip Ferrite Bead

Chip EMIFIL

Chip Common Mode Choke Coil

Block Type EMIFIL

Microchip Transformer (Balun)

Inductors for Power Lines

Inductors for General Circuits

RF Inductors

# Inductors for Power Lines

## DFE252012P\_D Series 1008 (2520) inch (mm)

### Specifications Sheet (with cautions/mounting/packaging)

Infotainment	<a href="https://search.murata.co.jp/Ceramy/image/img/P02/J(E)TE243A-9102.pdf">https://search.murata.co.jp/Ceramy/image/img/P02/J(E)TE243A-9102.pdf</a>
Powertrain/Safety	—

### Appearance/Dimensions

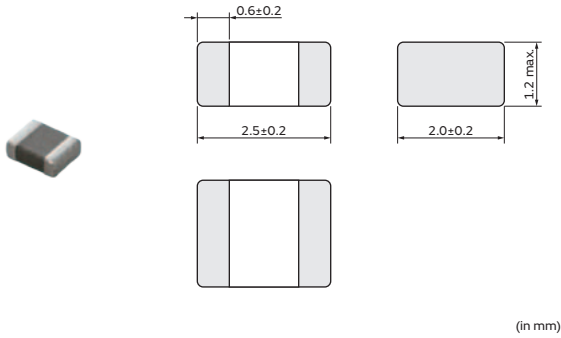

### Packaging

Code	Packaging	Minimum Quantity
=P2	ø180mm Embossed Taping	3000

### Rated Value (□: packaging code)

Part Number		Inductance	Inductance Test Frequency	Rated Current (Isat)*	Rated Current (Itemp)*	Max. of DC Resistance
Infotainment	Powertrain/Safety					
DFE252012PD-R33M□	—	0.33μH ±20%	1MHz	6000mA	4600mA	0.023Ω
DFE252012PD-R47M□	—	0.47μH ±20%	1MHz	5200mA	4000mA	0.027Ω
DFE252012PD-2R2M□	—	2.2μH ±20%	1MHz	2800mA	2200mA	0.084Ω
DFE252012PD-3R3M□	—	3.3μH ±20%	1MHz	2100mA	1700mA	0.14Ω
DFE252012PD-4R7M□	—	4.7μH ±20%	1MHz	1900mA	1400mA	0.2Ω
DFE252012PD-6R8M□	—	6.8μH ±20%	1MHz	1300mA	1000mA	0.4Ω
DFE252012PD-100M□	—	10μH ±20%	1MHz	1100mA	800mA	0.53Ω

Operating temp.range (Self-temp.rise included): -40 to 125°C

Absolute maximum voltage: 20Vdc

Inductance:

Measured with an LCR meter 4284A (Keysight) or equivalent.

RDC:

Measured with a Resistance Hitester 3541 (HIOKI) or equivalent.

Only for reflow soldering

\*Isat: Rated Current based on Inductance change

\*Itemp: Rated Current based on Temperature rise

Rated current (Isat) is specified when the decrease of the initial inductance value at 30%.

Rated current (Itemp) is specified when temperature of the inductor is raised 40°C by DC current.

Class of Magnetic Shield: Metal Alloy

### Inductance-Frequency Characteristics (Typ.)

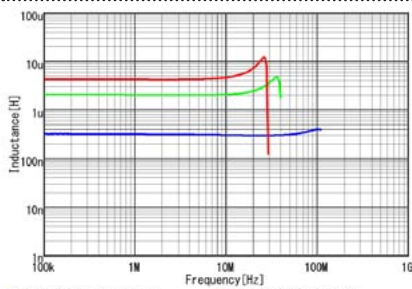

■ DFE252012PD-R33M 0.33μH  
 ■ DFE252012PD-4R7M 4.7μH  
 ■ DFE252012PD-2R2M 2.2μH

### Inductance-Current Characteristics (Typ.)

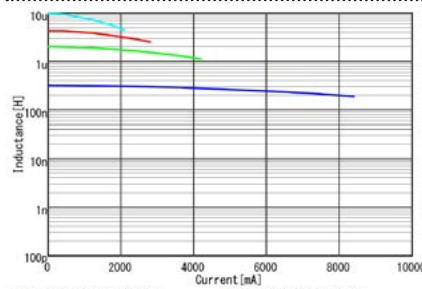

■ DFE252012PD-R33M 0.33μH  
 ■ DFE252012PD-4R7M 4.7μH  
 ■ DFE252012PD-2R2M 2.2μH  
 ■ DFE252012PD-100M 10μH

### Temperature Rise Characteristics (Typ.)

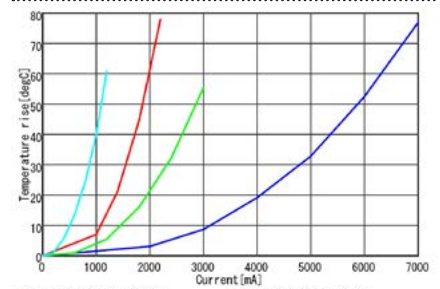

■ DFE252012PD-R33M 0.33μH  
 ■ DFE252012PD-4R7M 4.7μH  
 ■ DFE252012PD-2R2M 2.2μH  
 ■ DFE252012PD-100M 10μH

Continued on the following page. ↗

Continued from the preceding page. ↘

### Notice(Rating)

Max. current (DC, AC) as function of product temperature  
(derating curve).

Derating of Rated Current

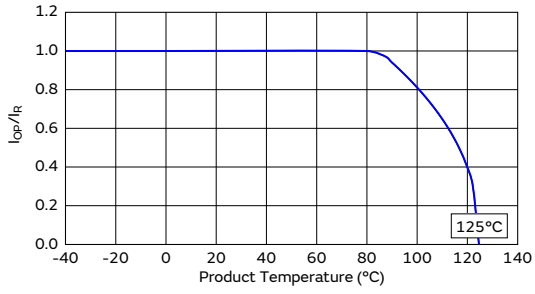

Chip Ferrite Bead

Chip EMIFIL

Chip Common Mode Choke Coil

Block Type EMIFIL

Microchip Transformer (Balun)

Inductors for Power Lines

Inductors for General Circuits

RF Inductors

# Inductors for Power Lines

## DFE2HCAH\_J0 Series 1008 (2520) inch (mm)

### Specifications Sheet (with cautions/mounting/packaging)

Infotainment	—
Powertrain/Safety	<a href="https://search.murata.co.jp/Ceramy/image/img/P02/JETE243A-9105.pdf">https://search.murata.co.jp/Ceramy/image/img/P02/JETE243A-9105.pdf</a>

### Appearance/Dimensions

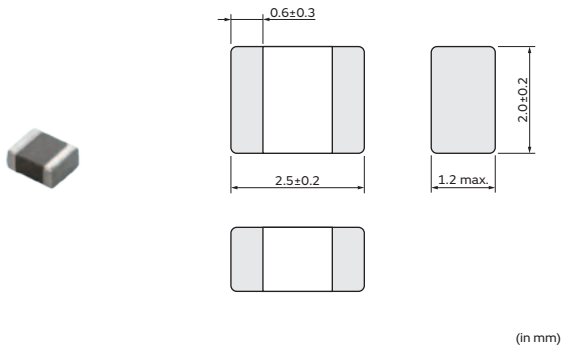

### Packaging

Code	Packaging	Minimum Quantity
L	ø180mm Embossed Taping	3000

### Rated Value (□: packaging code)

Part Number		Inductance	Inductance Test Frequency	Rated Current (Isat)*	Rated Current (Itemp)*	Max. of DC Resistance
Infotainment	Powertrain/Safety					
—	DFE2HCAHR33MJ0□	0.33μH ±20%	1MHz	5.8A	4.9A	0.021Ω
—	DFE2HCAHR47MJ0□	0.47μH ±20%	1MHz	5.1A	4.5A	0.025Ω
—	DFE2HCAHR68MJ0□	0.68μH ±20%	1MHz	4.4A	3.6A	0.031Ω
—	DFE2HCAH1R0MJ0□	1μH ±20%	1MHz	3.4A	3A	0.05Ω
—	DFE2HCAH1R5MJ0□	1.5μH ±20%	1MHz	2.9A	2.3A	0.074Ω
—	DFE2HCAH2R2MJ0□	2.2μH ±20%	1MHz	2.5A	1.9A	0.101Ω

Operating temp.range (Self-temp.rise included): -40 to 150°C

Operating temp.range (Self-temp.rise not included): -40 to 110°C

Class of Magnetic Shield: Metal Alloy

Only for reflow soldering

\*Isat: Rated Current based on Inductance change

\*Itemp: Rated Current based on Temperature rise

Rated current (Isat) is specified when the decrease of the initial inductance value at 30%. Rated current (Itemp) is specified when temperature of the inductor is raised 40°C by DC current.

Keep the temperature (ambient temperature plus self-generation of heat) under 150°C. It can be considered for use with DCDC converters with a maximum voltage of 40 V or less.

### Inductance-Frequency Characteristics (Typ.)

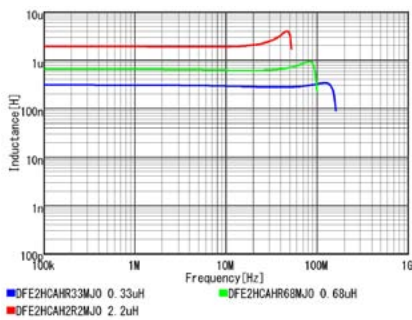

### Inductance-Current Characteristics (Typ.)

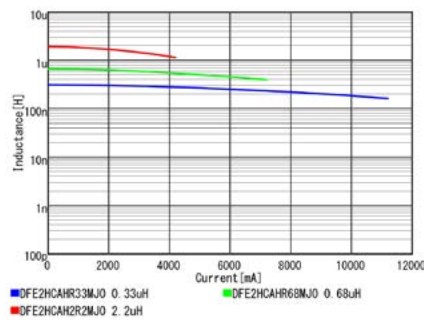

### Temperature Rise Characteristics (Typ.)

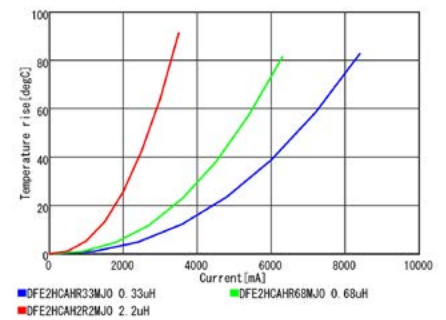

Continued on the following page. ↗

Continued from the preceding page. ↘

### Notice(Rating)

Max. current (DC, AC) as function of product temperature  
(derating curve).

Derating of Rated Current

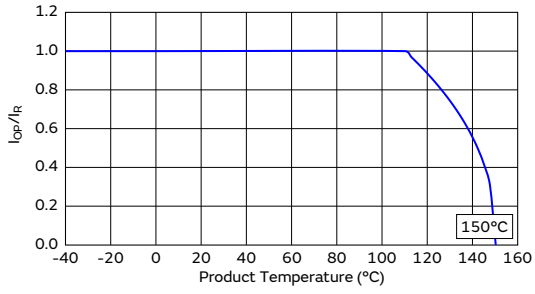

Chip Ferrite Bead

Chip EMIFIL

Chip Common Mode  
Choke Coil

Block Type EMIFIL

Microchip Transformer  
(Balun)

Inductors  
for Power Lines

Inductors for  
General Circuits

RF Inductors



# Inductors for Power Lines

## DFE322520F\_D Series 1210 (3225) inch (mm)

### Specifications Sheet (with cautions/mounting/packaging)

Infotainment	<a href="https://search.murata.co.jp/Ceramy/image/img/P02/J(E)TE243A-9104.pdf">https://search.murata.co.jp/Ceramy/image/img/P02/J(E)TE243A-9104.pdf</a>
Powertrain/Safety	—

### Appearance/Dimensions

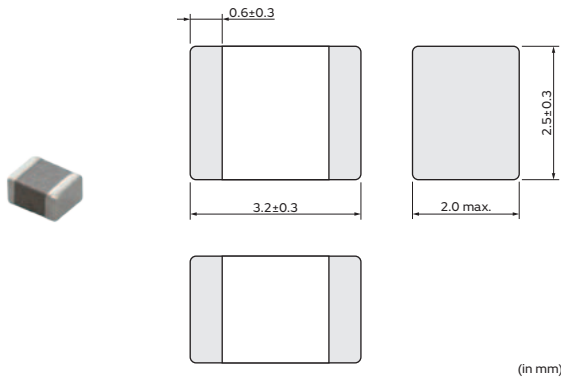

### Packaging

Code	Packaging	Minimum Quantity
=P2	ø180mm Embossed Taping	2000

### Rated Value (□: packaging code)

Part Number		Inductance	Inductance Test Frequency	Rated Current (Isat)*	Rated Current (Itemp)*	Max. of DC Resistance
Infotainment	Powertrain/Safety					
DFE322520FD-1R0M□	—	1μH ±20%	1MHz	7500mA	4100mA	0.022Ω
DFE322520FD-1R5M□	—	1.5μH ±20%	1MHz	6000mA	3400mA	0.031Ω
DFE322520FD-2R2M□	—	2.2μH ±20%	1MHz	5000mA	2900mA	0.046Ω
DFE322520FD-3R3M□	—	3.3μH ±20%	1MHz	4200mA	2300mA	0.065Ω
DFE322520FD-4R7M□	—	4.7μH ±20%	1MHz	3400mA	2000mA	0.098Ω

Operating temp.range (Self-temp.rise included): -40 to 125°C

Absolute maximum voltage: 20Vdc

Only for reflow soldering

\*Isat: Rated Current based on Inductance change

\*Itemp: Rated Current based on Temperature rise

Rated current (Isat) is specified when the decrease of the initial inductance value at 30%.

Rated current (Itemp) is specified when temperature of the inductor is raised 40°C by DC current.

Class of Magnetic Shield: Metal Alloy

### Inductance-Frequency Characteristics (Typ.)

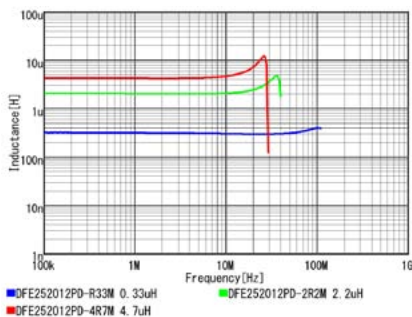

### Inductance-Current Characteristics (Typ.)

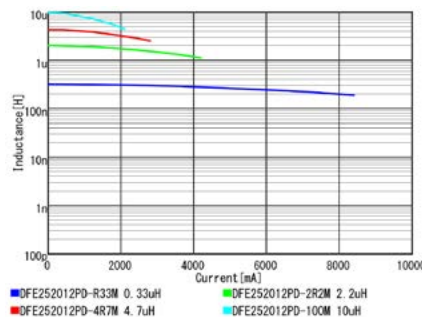

### Temperature Rise Characteristics (Typ.)

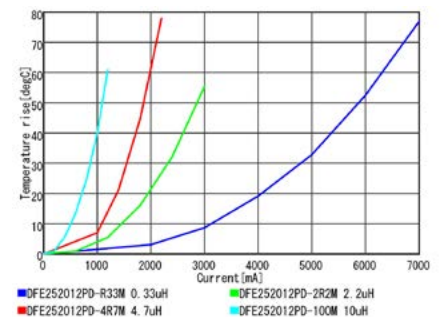

Continued on the following page. ↗

Continued from the preceding page. ↘

### Notice(Rating)

Max. current (DC, AC) as function of product temperature  
(derating curve).

Derating of Rated Current

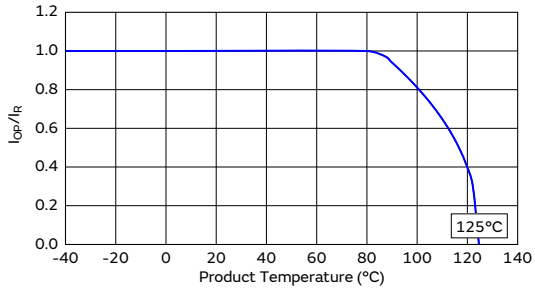

Chip Ferrite Bead

Chip EMIFIL

Chip Common Mode  
Choke Coil

Block Type EMIFIL

Microchip Transformer  
(Balun)

Inductors  
for Power Lines

Inductors for  
General Circuits

RF Inductors

## Inductors for Power Lines

# LQH2MPZ\_GR Series 0806 (2016) inch (mm)

### Specifications Sheet (with cautions/mounting/packaging)

Infotainment	<a href="https://search.murata.co.jp/Ceramy/image/img/P02/JELF243A-9134.pdf">https://search.murata.co.jp/Ceramy/image/img/P02/JELF243A-9134.pdf</a>
Powertrain/Safety	—

### Appearance/Dimensions

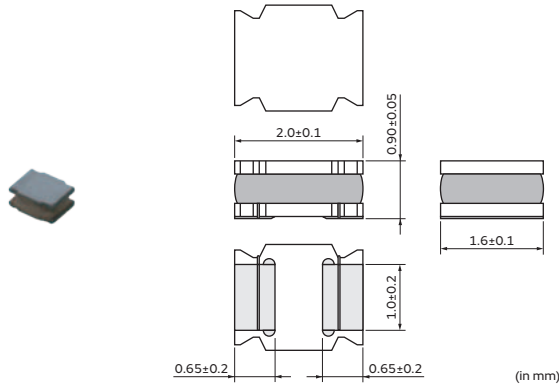

### Packaging

Code	Packaging	Minimum Quantity
L	ø180mm Embossed Taping	3000

### Rated Value (□: packaging code)

Part Number		Inductance	Inductance Test Frequency	Rated Current (Isat)*	Rated Current (Itemp)*	DC Resistance	S.R.F* (min.)
Infotainment	Powertrain/Safety						
LQH2MPZR33NGR□	—	0.33μH ±30%	1MHz	2200mA	1130mA(Ambient temp.85°C) 670mA(Ambient temp.105°C)	0.15Ω±20%	130MHz
LQH2MPZR47NGR□	—	0.47μH ±30%	1MHz	1950mA	1060mA(Ambient temp.85°C) 630mA(Ambient temp.105°C)	0.18Ω±20%	120MHz
LQH2MPZ1R0NGR□	—	1μH ±30%	1MHz	1550mA	900mA(Ambient temp.85°C) 540mA(Ambient temp.105°C)	0.25Ω±20%	100MHz
LQH2MPZ1R5NGR□	—	1.5μH ±30%	1MHz	1330mA	790mA(Ambient temp.85°C) 470mA(Ambient temp.105°C)	0.32Ω±20%	60MHz
LQH2MPZ2R2MGR□	—	2.2μH ±20%	1MHz	1180mA	680mA(Ambient temp.85°C) 400mA(Ambient temp.105°C)	0.39Ω±20%	50MHz
LQH2MPZ3R3MGR□	—	3.3μH ±20%	1MHz	1020mA	640mA(Ambient temp.85°C) 380mA(Ambient temp.105°C)	0.47Ω±20%	45MHz
LQH2MPZ4R7MGR□	—	4.7μH ±20%	1MHz	870mA	580mA(Ambient temp.85°C) 340mA(Ambient temp.105°C)	0.60Ω±20%	40MHz
LQH2MPZ6R8MGR□	—	6.8μH ±20%	1MHz	730mA	530mA(Ambient temp.85°C) 310mA(Ambient temp.105°C)	0.72Ω±20%	35MHz
LQH2MPZ100MGR□	—	10μH ±20%	1MHz	610mA	480mA(Ambient temp.85°C) 280mA(Ambient temp.105°C)	0.88Ω±20%	30MHz
LQH2MPZ150MGR□	—	15μH ±20%	1MHz	490mA	340mA(Ambient temp.85°C) 200mA(Ambient temp.105°C)	1.7Ω±20%	25MHz
LQH2MPZ220MGR□	—	22μH ±20%	1MHz	410mA	290mA(Ambient temp.85°C) 170mA(Ambient temp.105°C)	2.1Ω±20%	20MHz

Operating temp.range (Self-temp.rise included): -40 to 125°C

Operating temp.range (Self-temp.rise not included): -40 to 105°C

Class of Magnetic Shield: Ferrite Core

Only for reflow soldering

\*Isat: Rated Current based on Inductance change

\*Itemp: Rated Current based on Temperature rise

\*S.R.F: Self Resonant Frequency

When rated current is applied to the products, inductance will be within ±30% of initial inductance value range. Keep the temperature (ambient temperature plus self-generation of heat) under 125°C. When rated current is applied to the products, temperature rise caused by self-generated heat shall be limited to 40°C max (ambient temperature 85°C max). When rated current is applied to the products, temperature rise caused by self-generated heat shall be limited to 20°C max (ambient temperature 85°C to 105°C).

Continued on the following page. ↗

Continued from the preceding page. ↘

Part Number		Inductance	Inductance Test Frequency	Rated Current (Isat)*	Rated Current (Itemp)*	DC Resistance	S.R.F* (min.)
Infotainment	Powertrain/Safety						
LQH2MPZ330MGR□	—	33μH ±20%	1MHz	310mA	200mA(Ambient temp.85°C) 120mA(Ambient temp.105°C)	4.3Ω±20%	15MHz
LQH2MPZ470MGR□	—	47μH ±20%	1MHz	270mA	180mA(Ambient temp.85°C) 110mA(Ambient temp.105°C)	5.3Ω±20%	10MHz
LQH2MPZ680MGR□	—	68μH ±20%	1MHz	230mA	160mA(Ambient temp.85°C) 100mA(Ambient temp.105°C)	6.7Ω±20%	7MHz
LQH2MPZ820MGR□	—	82μH ±20%	1MHz	210mA	150mA(Ambient temp.85°C) 90mA(Ambient temp.105°C)	7.3Ω±20%	5MHz

Operating temp.range (Self-temp.rise included): -40 to 125°C  
 Operating temp.range (Self-temp.rise not included): -40 to 105°C  
 Class of Magnetic Shield: Ferrite Core  
 Only for reflow soldering

\*Isat: Rated Current based on Inductance change  
 \*Itemp: Rated Current based on Temperature rise  
 \*S.R.F: Self Resonant Frequency

When rated current is applied to the products, inductance will be within ±30% of initial inductance value range. Keep the temperature (ambient temperature plus self-generation of heat) under 125°C. When rated current is applied to the products, temperature rise caused by self-generated heat shall be limited to 40°C max (ambient temperature 85°C max). When rated current is applied to the products, temperature rise caused by self-generated heat shall be limited to 20°C max (ambient temperature 85°C to 105°C).

### Inductance-Frequency Characteristics (Typ.)

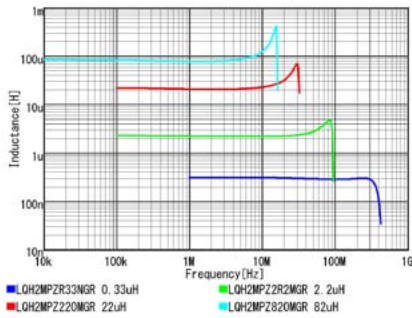

### Inductance-Current Characteristics (Typ.)

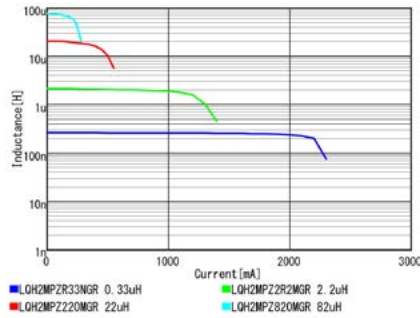

### Temperature Rise Characteristics (Typ.)

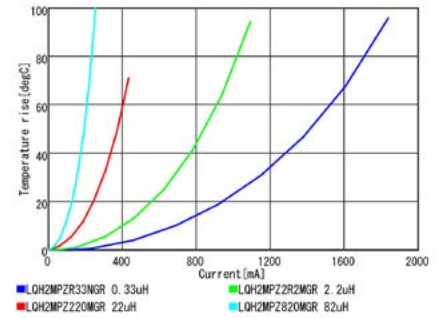

Chip Ferrite Bead

Chip EMIFIL

Chip Common Mode Choke Coil

Block Type EMIFIL

Microchip Transformer (Balun)

Inductors for Power Lines

Inductors for General Circuits

RF Inductors

## Inductors for Power Lines

# LQH2HPZ\_DR Series 1008 (2520) inch (mm)

### Specifications Sheet (with cautions/mounting/packaging)

Infotainment	<a href="https://search.murata.co.jp/Ceramy/image/img/P02/JELF243A-9143.pdf">https://search.murata.co.jp/Ceramy/image/img/P02/JELF243A-9143.pdf</a>
Powertrain/Safety	—

### Appearance/Dimensions

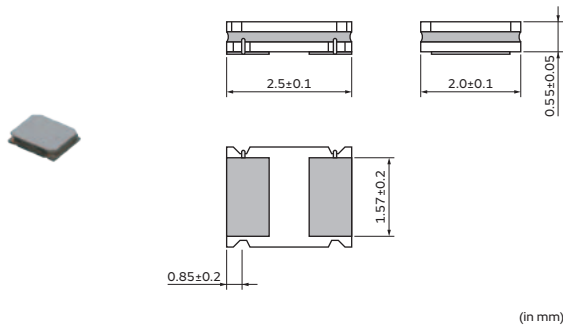

### Packaging

Code	Packaging	Minimum Quantity
L	ø180mm Embossed Taping	4000

### Rated Value (□: packaging code)

Part Number		Inductance	Inductance Test Frequency	Rated Current (Isat)*	Rated Current (Itemp)*	DC Resistance	S.R.F.* (min.)
Infotainment	Powertrain/Safety						
LQH2HPZR47MDR□	—	0.47μH ±20%	1MHz	1670mA	1250mA(Ambient temp.85°C) 750mA(Ambient temp.105°C)	0.14Ω±20%	120MHz
LQH2HPZ1R0MDR□	—	1μH ±20%	1MHz	1370mA	960mA(Ambient temp.85°C) 580mA(Ambient temp.105°C)	0.24Ω±20%	100MHz
LQH2HPZ1R5MDR□	—	1.5μH ±20%	1MHz	1120mA	900mA(Ambient temp.85°C) 540mA(Ambient temp.105°C)	0.29Ω±20%	60MHz
LQH2HPZ2R2MDR□	—	2.2μH ±20%	1MHz	850mA	820mA(Ambient temp.85°C) 500mA(Ambient temp.105°C)	0.34Ω±20%	50MHz
LQH2HPZ3R3MDR□	—	3.3μH ±20%	1MHz	750mA	730mA(Ambient temp.85°C) 440mA(Ambient temp.105°C)	0.45Ω±20%	45MHz
LQH2HPZ4R7MDR□	—	4.7μH ±20%	1MHz	650mA	650mA(Ambient temp.85°C) 390mA(Ambient temp.105°C)	0.56Ω±20%	40MHz
LQH2HPZ6R8MDR□	—	6.8μH ±20%	1MHz	550mA	490mA(Ambient temp.85°C) 300mA(Ambient temp.105°C)	1.0Ω±20%	35MHz
LQH2HPZ100MDR□	—	10μH ±20%	1MHz	420mA	430mA(Ambient temp.85°C) 260mA(Ambient temp.105°C)	1.2Ω±20%	30MHz
LQH2HPZ150MDR□	—	15μH ±20%	1MHz	340mA	290mA(Ambient temp.85°C) 180mA(Ambient temp.105°C)	2.5Ω±20%	25MHz
LQH2HPZ220MDR□	—	22μH ±20%	1MHz	260mA	270mA(Ambient temp.85°C) 170mA(Ambient temp.105°C)	3.0Ω±20%	20MHz

Operating temp.range (Self-temp.rise included): -40 to 125°C

Operating temp.range (Self-temp.rise not included): -40 to 105°C

Class of Magnetic Shield: Magnetic Resin

Only for reflow soldering

\*Isat: Rated Current based on Inductance change

\*Itemp: Rated Current based on Temperature rise

\*S.R.F: Self Resonant Frequency

When rated current is applied to the products, inductance will be within ±30% of initial inductance value range. Keep the temperature (ambient temperature plus self-generation of heat) under 125°C. When rated current is applied to the products, temperature rise caused by self-generated heat shall be limited to 40°C max(ambient temperature 85°C max). When rated current is applied to the products, temperature rise caused by self-generated heat shall be limited to 20°C max(ambient temperature 85°C to 105°C).

Continued on the following page. ↗

Continued from the preceding page. ↘

### Inductance-Frequency Characteristics (Typ.)

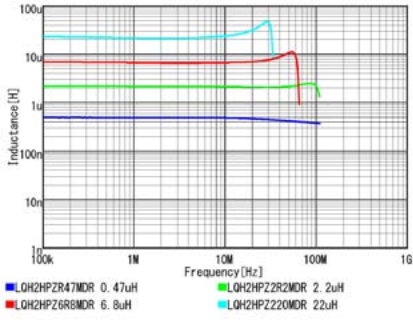

### Inductance-Current Characteristics (Typ.)

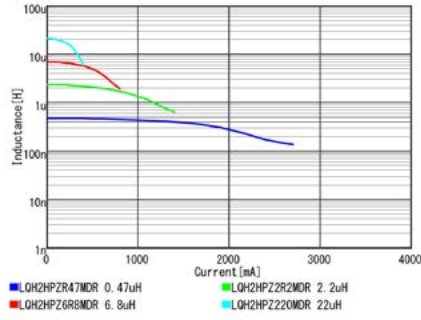

### Temperature Rise Characteristics (Typ.)

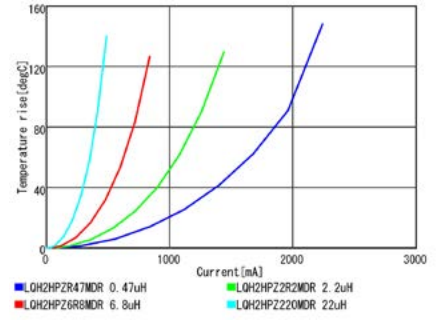

Chip Ferrite Bead  
 Chip EMIFIL  
 Chip Common Mode Choke Coil  
 Block Type EMIFIL  
 Microchip Transformer (Balun)  
 Inductors for Power Lines  
 Inductors for General Circuits  
 RF Inductors

## Inductors for Power Lines

# LQH2HPZ\_GR Series 1008 (2520) inch (mm)

### Specifications Sheet (with cautions/mounting/packaging)

Infotainment	<a href="https://search.murata.co.jp/Ceramy/image/img/P02/JELF243A-9128.pdf">https://search.murata.co.jp/Ceramy/image/img/P02/JELF243A-9128.pdf</a>
Powertrain/Safety	—

### Appearance/Dimensions

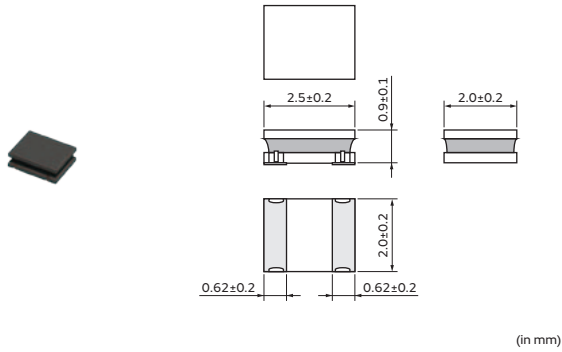

### Packaging

Code	Packaging	Minimum Quantity
L	ø180mm Embossed Taping	3000

### Rated Value (□: packaging code)

Part Number		Inductance	Inductance Test Frequency	Rated Current (Isat)*	Rated Current (Itemp)*	DC Resistance	S.R.F* (min.)
Infotainment	Powertrain/Safety						
LQH2HPZR47MGR□	—	0.47μH ±20%	1MHz	2900mA	2520mA(Ambient temp.85°C) 1470mA(Ambient temp.105°C)	0.045Ω±20%	120MHz
LQH2HPZR68MGR□	—	0.68μH ±20%	1MHz	2430mA	2330mA(Ambient temp.85°C) 1350mA(Ambient temp.105°C)	0.055Ω±20%	110MHz
LQH2HPZ1R0MGR□	—	1μH ±20%	1MHz	2130mA	2100mA(Ambient temp.85°C) 1200mA(Ambient temp.105°C)	0.068Ω±20%	100MHz
LQH2HPZ1R5MGR□	—	1.5μH ±20%	1MHz	1700mA	1850mA(Ambient temp.85°C) 1110mA(Ambient temp.105°C)	0.087Ω±20%	90MHz
LQH2HPZ2R2MGR□	—	2.2μH ±20%	1MHz	1550mA	1470mA(Ambient temp.85°C) 850mA(Ambient temp.105°C)	0.134Ω±20%	80MHz
LQH2HPZ3R3MGR□	—	3.3μH ±20%	1MHz	1230mA	1100mA(Ambient temp.85°C) 660mA(Ambient temp.105°C)	0.225Ω±20%	70MHz
LQH2HPZ4R7MGR□	—	4.7μH ±20%	1MHz	1090mA	1000mA(Ambient temp.85°C) 570mA(Ambient temp.105°C)	0.300Ω±20%	50MHz
LQH2HPZ6R8MGR□	—	6.8μH ±20%	1MHz	830mA	860mA(Ambient temp.85°C) 490mA(Ambient temp.105°C)	0.395Ω±20%	40MHz
LQH2HPZ100MGR□	—	10μH ±20%	1MHz	700mA	710mA(Ambient temp.85°C) 430mA(Ambient temp.105°C)	0.560Ω±20%	30MHz
LQH2HPZ150MGR□	—	15μH ±20%	1MHz	570mA	560mA(Ambient temp.85°C) 310mA(Ambient temp.105°C)	0.925Ω±20%	20MHz
LQH2HPZ220MGR□	—	22μH ±20%	1MHz	460mA	430mA(Ambient temp.85°C) 250mA(Ambient temp.105°C)	1.360Ω±20%	15MHz

Operating temp.range (Self-temp.rise included): -40 to 125°C

Operating temp.range (Self-temp.rise not included): -40 to 105°C

Class of Magnetic Shield: Magnetic Resin

Only for reflow soldering

\*Isat: Rated Current based on Inductance change

\*Itemp: Rated Current based on Temperature rise

\*S.R.F: Self Resonant Frequency

When rated current is applied to the products, inductance will be within ±30% of initial inductance value range. Keep the temperature (ambient temperature plus self-generation of heat) under 125°C. When rated current is applied to the products, temperature rise caused by self-generated heat shall be limited to 40°C max(ambient temperature 85°C max). When rated current is applied to the products, temperature rise caused by self-generated heat shall be limited to 20°C max(ambient temperature 85°C to 105°C).

Continued on the following page. ↗

Continued from the preceding page. ↘

**Inductance-Frequency Characteristics (Typ.)**

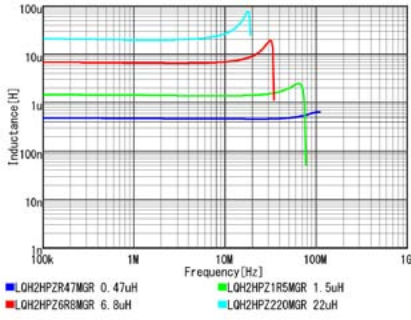

**Inductance-Current Characteristics (Typ.)**

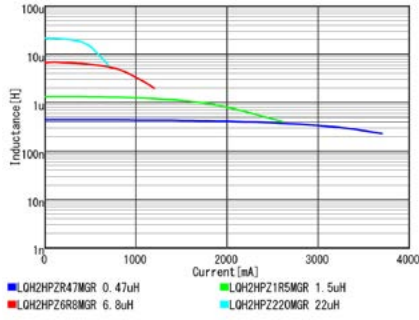

**Temperature Rise Characteristics (Typ.)**

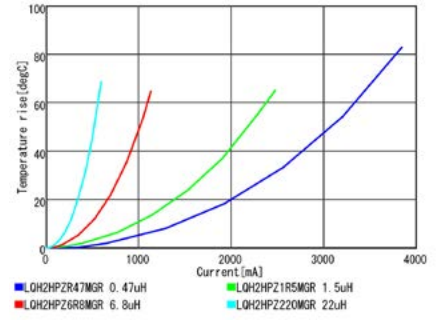

Chip Ferrite Bead  
 Chip EMIFIL  
 Chip Common Mode Choke Coil  
 Block Type EMIFIL  
 Microchip Transformer (Balun)  
 Inductors for Power Lines  
 Inductors for General Circuits  
 RF Inductors



## Inductors for Power Lines

# LQH2HPZ\_JR Series 1008 (2520) inch (mm)

### Specifications Sheet (with cautions/mounting/packaging)

Infotainment	<a href="https://search.murata.co.jp/Ceramy/image/img/P02/JELF243A-9129.pdf">https://search.murata.co.jp/Ceramy/image/img/P02/JELF243A-9129.pdf</a>
Powertrain/Safety	—

### Appearance/Dimensions

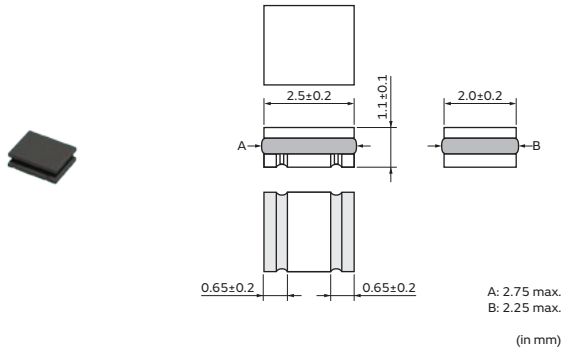

### Packaging

Code	Packaging	Minimum Quantity
L	ø180mm Embossed Taping	2000

### Rated Value (□: packaging code)

Part Number		Inductance	Inductance Test Frequency	Rated Current (Isat)*	Rated Current (Itemp)*	DC Resistance	S.R.F* (min.)
Infotainment	Powertrain/Safety						
LQH2HPZR47NJR□	—	0.47μH ±30%	1MHz	3500mA	2750mA(Ambient temp.85°C) 1650mA(Ambient temp.105°C)	0.031Ω±20%	190MHz
LQH2HPZ1R0NJR□	—	1μH ±30%	1MHz	2600mA	2400mA(Ambient temp.85°C) 1440mA(Ambient temp.105°C)	0.048Ω±20%	120MHz
LQH2HPZ1R2NJR□	—	1.2μH ±30%	1MHz	2450mA	2070mA(Ambient temp.85°C) 1240mA(Ambient temp.105°C)	0.055Ω±20%	100MHz
LQH2HPZ1R5NJR□	—	1.5μH ±30%	1MHz	2200mA	1810mA(Ambient temp.85°C) 1080mA(Ambient temp.105°C)	0.075Ω±20%	95MHz
LQH2HPZ2R2MJR□	—	2.2μH ±20%	1MHz	1700mA	1650mA(Ambient temp.85°C) 990mA(Ambient temp.105°C)	0.092Ω±20%	50MHz
LQH2HPZ3R3MJR□	—	3.3μH ±20%	1MHz	1450mA	1420mA(Ambient temp.85°C) 850mA(Ambient temp.105°C)	0.13Ω±20%	45MHz
LQH2HPZ4R7MJR□	—	4.7μH ±20%	1MHz	1230mA	1290mA(Ambient temp.85°C) 770mA(Ambient temp.105°C)	0.17Ω±20%	40MHz
LQH2HPZ6R8MJR□	—	6.8μH ±20%	1MHz	1050mA	1000mA(Ambient temp.85°C) 600mA(Ambient temp.105°C)	0.26Ω±20%	35MHz
LQH2HPZ100MJR□	—	10μH ±20%	1MHz	830mA	830mA(Ambient temp.85°C) 490mA(Ambient temp.105°C)	0.38Ω±20%	30MHz
LQH2HPZ150MJR□	—	15μH ±20%	1MHz	690mA	710mA(Ambient temp.85°C) 420mA(Ambient temp.105°C)	0.55Ω±20%	20MHz
LQH2HPZ220MJR□	—	22μH ±20%	1MHz	530mA	540mA(Ambient temp.85°C) 320mA(Ambient temp.105°C)	0.84Ω±20%	20MHz

Operating temp.range (Self-temp.rise included): -40 to 125°C

Operating temp.range (Self-temp.rise not included): -40 to 105°C

Class of Magnetic Shield: Magnetic Resin

Only for reflow soldering

\*Isat: Rated Current based on Inductance change

\*Itemp: Rated Current based on Temperature rise

\*S.R.F: Self Resonant Frequency

When rated current is applied to the products, inductance will be within ±30% of initial inductance value range. Keep the temperature (ambient temperature plus self-generation of heat) under 125°C. When rated current is applied to the products, temperature rise caused by self-generated heat shall be limited to 40°C max (ambient temperature 85°C max). When rated current is applied to the products, temperature rise caused by self-generated heat shall be limited to 20°C max (ambient temperature 85°C to 105°C).

Continued on the following page. ↗

Continued from the preceding page. ↘

### Inductance-Frequency Characteristics (Typ.)

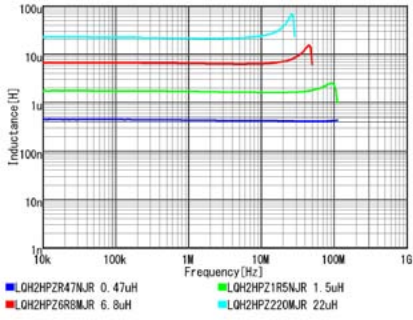

### Inductance-Current Characteristics (Typ.)

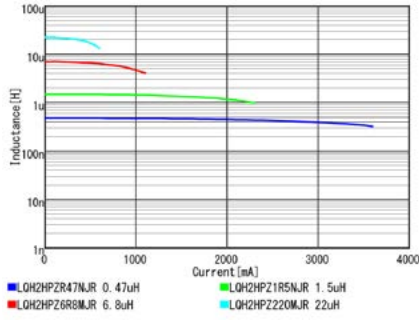

### Temperature Rise Characteristics (Typ.)

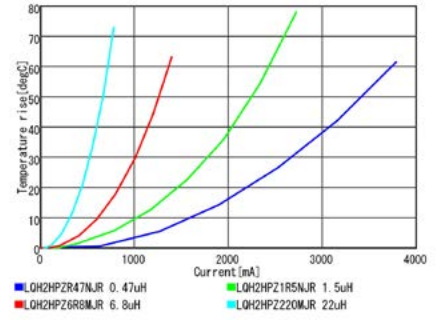

Chip Ferrite Bead

Chip EMIFIL

Chip Common Mode Choke Coil

Block Type EMIFIL

Microchip Transformer (Balun)

Inductors for Power Lines

Inductors for General Circuits

RF Inductors

## Inductors for Power Lines

# LQH3NPZ\_GR Series 1212 (3030) inch (mm)

### Specifications Sheet (with cautions/mounting/packaging)

Infotainment	<a href="https://search.murata.co.jp/Ceramy/image/img/P02/JELF243A-9130.pdf">https://search.murata.co.jp/Ceramy/image/img/P02/JELF243A-9130.pdf</a>
Powertrain/Safety	—

### Appearance/Dimensions

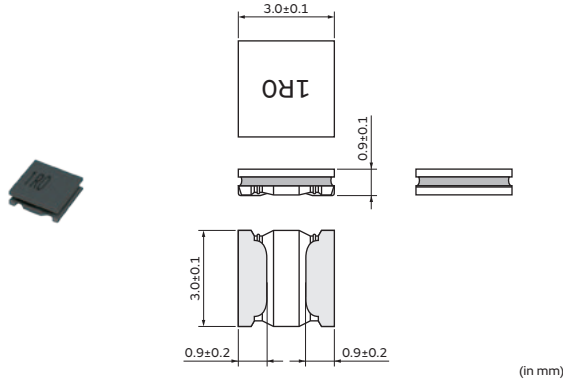

### Packaging

Code	Packaging	Minimum Quantity
L	ø180mm Embossed Taping	3000

### Rated Value (□: packaging code)

Part Number		Inductance	Inductance Test Frequency	Rated Current (Isat)*	Rated Current (Itemp)*	DC Resistance	S.R.F* (min.)
Infotainment	Powertrain/Safety						
LQH3NPZR47NGR□	—	0.47μH ±30%	1MHz	2820mA	2540mA(Ambient temp.85°C) 1520mA(Ambient temp.105°C)	0.047Ω±20%	180MHz
LQH3NPZ1R0MGR□	—	1μH ±20%	1MHz	1700mA	2080mA(Ambient temp.85°C) 1240mA(Ambient temp.105°C)	0.062Ω±20%	100MHz
LQH3NPZ1R5MGR□	—	1.5μH ±20%	1MHz	1400mA	2040mA(Ambient temp.85°C) 1220mA(Ambient temp.105°C)	0.074Ω±20%	80MHz
LQH3NPZ2R2MGR□	—	2.2μH ±20%	1MHz	1180mA	1730mA(Ambient temp.85°C) 1030mA(Ambient temp.105°C)	0.087Ω±20%	50MHz
LQH3NPZ3R3MGR□	—	3.3μH ±20%	1MHz	1050mA	1580mA(Ambient temp.85°C) 940mA(Ambient temp.105°C)	0.12Ω±20%	30MHz
LQH3NPZ4R7MGR□	—	4.7μH ±20%	1MHz	850mA	1520mA(Ambient temp.85°C) 910mA(Ambient temp.105°C)	0.14Ω±20%	27MHz
LQH3NPZ6R8MGR□	—	6.8μH ±20%	1MHz	720mA	1140mA(Ambient temp.85°C) 680mA(Ambient temp.105°C)	0.23Ω±20%	25MHz
LQH3NPZ100MGR□	—	10μH ±20%	1MHz	570mA	1120mA(Ambient temp.85°C) 670mA(Ambient temp.105°C)	0.28Ω±20%	20MHz
LQH3NPZ150MGR□	—	15μH ±20%	1MHz	480mA	900mA(Ambient temp.85°C) 540mA(Ambient temp.105°C)	0.39Ω±20%	15MHz
LQH3NPZ220MGR□	—	22μH ±20%	1MHz	390mA	750mA(Ambient temp.85°C) 450mA(Ambient temp.105°C)	0.53Ω±20%	10MHz
LQH3NPZ330MGR□	—	33μH ±20%	1MHz	320mA	600mA(Ambient temp.85°C) 360mA(Ambient temp.105°C)	0.86Ω±20%	8MHz

Operating temp.range (Self-temp.rise included): -40 to 125°C

Operating temp.range (Self-temp.rise not included): -40 to 105°C

Class of Magnetic Shield: Magnetic Resin

Only for reflow soldering

\*Isat: Rated Current based on Inductance change

\*Itemp: Rated Current based on Temperature rise

\*S.R.F: Self Resonant Frequency

When rated current is applied to the products, inductance will be within ±30% of initial inductance value range. When rated current is applied to the products, temperature rise caused by self-generated heat shall be limited to 40°C max (ambient temperature 85°C max). When rated current is applied to the products, temperature rise caused by self-generated heat shall be limited to 20°C max (ambient temperature 85°C to 105°C). Keep the temperature (ambient temperature plus self-generation of heat) under 125°C.

Continued on the following page. ↗

Continued from the preceding page. ↘

Part Number		Inductance	Inductance Test Frequency	Rated Current (I <sub>sat</sub> )*	Rated Current (I <sub>temp</sub> )*	DC Resistance	S.R.F.* (min.)
Infotainment	Powertrain/Safety						
LQH3NPZ470MGR□	—	47μH ±20%	1MHz	260mA	460mA(Ambient temp.85°C) 270mA(Ambient temp.105°C)	1.4Ω±20%	5MHz

Operating temp.range (Self-temp.rise included): -40 to 125°C  
 Operating temp.range (Self-temp.rise not included): -40 to 105°C

Class of Magnetic Shield: Magnetic Resin

Only for reflow soldering

\*I<sub>sat</sub>: Rated Current based on Inductance change

\*I<sub>temp</sub>: Rated Current based on Temperature rise

\*S.R.F.: Self Resonant Frequency

When rated current is applied to the products, inductance will be within ±30% of initial inductance value range. When rated current is applied to the products, temperature rise caused by self-generated heat shall be limited to 40°C max (ambient temperature 85°C max). When rated current is applied to the products, temperature rise caused by self-generated heat shall be limited to 20°C max (ambient temperature 85°C to 105°C). Keep the temperature (ambient temperature plus self-generation of heat) under 125°C.

### Inductance-Frequency Characteristics (Typ.)

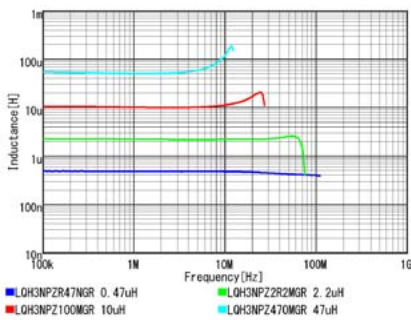

### Inductance-Current Characteristics (Typ.)

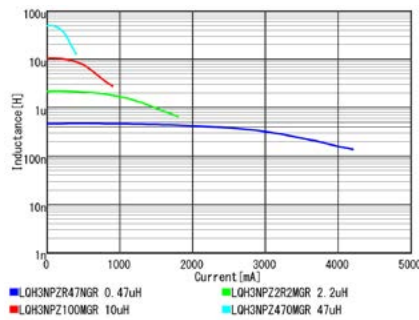

### Temperature Rise Characteristics (Typ.)

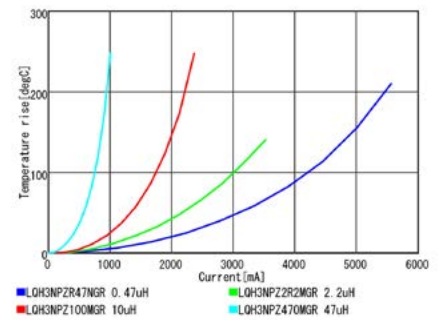

Chip Ferrite Bead

Chip EMIFIL

Chip Common Mode Choke Coil

Block Type EMIFIL

Microchip Transformer (Balun)

Inductors for Power Lines

Inductors for General Circuits

RF Inductors

## Inductors for Power Lines

# LQH3NPZ\_JR Series 1212 (3030) inch (mm)

### Specifications Sheet (with cautions/mounting/packaging)

Infotainment	<a href="https://search.murata.co.jp/Ceramy/image/img/P02/JELF243A-9131.pdf">https://search.murata.co.jp/Ceramy/image/img/P02/JELF243A-9131.pdf</a>
Powertrain/Safety	—

### Appearance/Dimensions

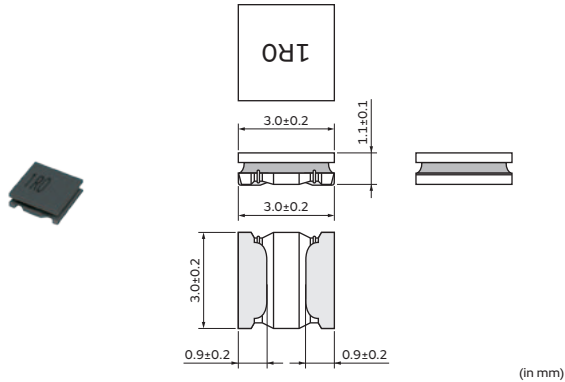

### Packaging

Code	Packaging	Minimum Quantity
L	ø180mm Embossed Taping	2000

### Rated Value (□: packaging code)

Part Number		Inductance	Inductance Test Frequency	Rated Current (Isat)*	Rated Current (Itemp)*	DC Resistance	S.R.F* (min.)
Infotainment	Powertrain/Safety						
LQH3NPZR68NJR□	—	0.68μH ±30%	1MHz	2700mA	2860mA(Ambient temp.85°C) 1280mA(Ambient temp.105°C)	0.032Ω±20%	130MHz
LQH3NPZ1R0MJR□	—	1μH ±20%	1MHz	2250mA	2780mA(Ambient temp.85°C) 1230mA(Ambient temp.105°C)	0.040Ω±20%	100MHz
LQH3NPZ1R5MJR□	—	1.5μH ±20%	1MHz	1950mA	2510mA(Ambient temp.85°C) 1100mA(Ambient temp.105°C)	0.049Ω±20%	60MHz
LQH3NPZ2R2MJR□	—	2.2μH ±20%	1MHz	1800mA	2200mA(Ambient temp.85°C) 980mA(Ambient temp.105°C)	0.068Ω±20%	45MHz
LQH3NPZ3R3MJR□	—	3.3μH ±20%	1MHz	1350mA	1700mA(Ambient temp.85°C) 750mA(Ambient temp.105°C)	0.095Ω±20%	45MHz
LQH3NPZ4R7MJR□	—	4.7μH ±20%	1MHz	1180mA	1580mA(Ambient temp.85°C) 710mA(Ambient temp.105°C)	0.12Ω±20%	40MHz
LQH3NPZ6R8MJR□	—	6.8μH ±20%	1MHz	970mA	1360mA(Ambient temp.85°C) 610mA(Ambient temp.105°C)	0.18Ω±20%	35MHz
LQH3NPZ100MJR□	—	10μH ±20%	1MHz	810mA	1200mA(Ambient temp.85°C) 530mA(Ambient temp.105°C)	0.24Ω±20%	30MHz
LQH3NPZ150MJR□	—	15μH ±20%	1MHz	650mA	870mA(Ambient temp.85°C) 370mA(Ambient temp.105°C)	0.38Ω±20%	25MHz
LQH3NPZ220MJR□	—	22μH ±20%	1MHz	520mA	800mA(Ambient temp.85°C) 350mA(Ambient temp.105°C)	0.50Ω±20%	20MHz
LQH3NPZ330MJR□	—	33μH ±20%	1MHz	420mA	630mA(Ambient temp.85°C) 280mA(Ambient temp.105°C)	0.79Ω±20%	15MHz

Operating temp.range (Self-temp.rise included): -40 to 125°C

Operating temp.range (Self-temp.rise not included): -40 to 105°C

Class of Magnetic Shield: Magnetic Resin

Only for reflow soldering

\*Isat: Rated Current based on Inductance change

\*Itemp: Rated Current based on Temperature rise

\*S.R.F: Self Resonant Frequency

When rated current is applied to the products, inductance will be within ±30% of initial inductance value range. Keep the temperature (ambient temperature plus self-generation of heat) under 125°C. When rated current is applied to the products, temperature rise caused by self-generated heat shall be limited to 40°C max (ambient temperature 85°C max). When rated current is applied to the products, temperature rise caused by self-generated heat shall be limited to 20°C max (ambient temperature 85°C to 105°C).

Continued on the following page. ↗

Continued from the preceding page. ↘

Part Number		Inductance	Inductance Test Frequency	Rated Current (I <sub>sat</sub> )*	Rated Current (I <sub>temp</sub> )*	DC Resistance	S.R.F* (min.)
Infotainment	Powertrain/Safety						
LQH3NPZ470MJR□	—	47μH ±20%	1MHz	360mA	570mA(Ambient temp.85°C) 240mA(Ambient temp.105°C)	1.0Ω±20%	10MHz

Operating temp.range (Self-temp.rise included): -40 to 125°C  
 Operating temp.range (Self-temp.rise not included): -40 to 105°C  
 Class of Magnetic Shield: Magnetic Resin

Only for reflow soldering

\*I<sub>sat</sub>: Rated Current based on Inductance change

\*I<sub>temp</sub>: Rated Current based on Temperature rise

\*S.R.F: Self Resonant Frequency

When rated current is applied to the products, inductance will be within ±30% of initial inductance value range. Keep the temperature (ambient temperature plus self-generation of heat) under 125°C. When rated current is applied to the products, temperature rise caused by self-generated heat shall be limited to 40°C max (ambient temperature 85°C max). When rated current is applied to the products, temperature rise caused by self-generated heat shall be limited to 20°C max (ambient temperature 85°C to 105°C).

### Inductance-Frequency Characteristics (Typ.)

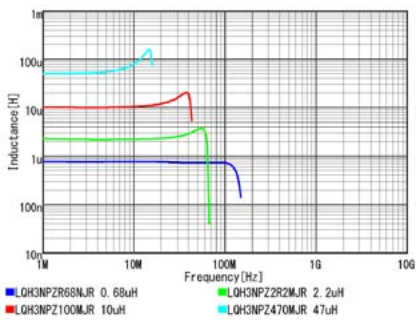

### Inductance-Current Characteristics (Typ.)

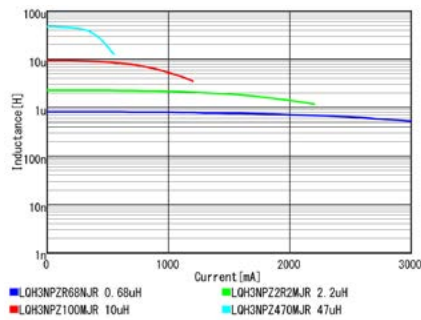

### Temperature Rise Characteristics (Typ.)

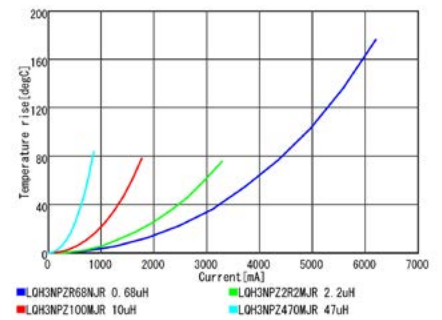

## Inductors for Power Lines

# LQH3NPZ\_ME/LQH3NPH\_ME Series 1212 (3030) inch (mm)

### Specifications Sheet (with cautions/mounting/packaging)

Infotainment	<a href="https://search.murata.co.jp/Ceramy/image/img/P02/JELF243A-9140.pdf">https://search.murata.co.jp/Ceramy/image/img/P02/JELF243A-9140.pdf</a>
Powertrain/Safety	<a href="https://search.murata.co.jp/Ceramy/image/img/P02/JELF243A-9148.pdf">https://search.murata.co.jp/Ceramy/image/img/P02/JELF243A-9148.pdf</a>

### Appearance/Dimensions

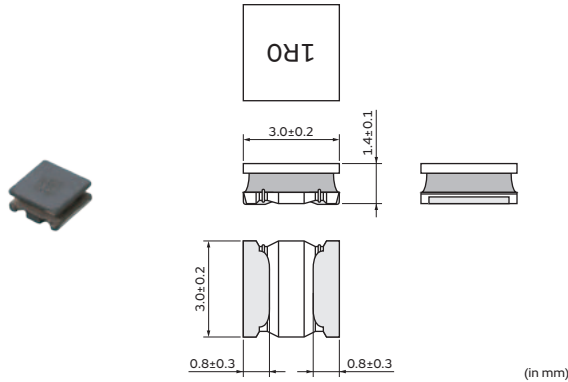

### Packaging

Code	Packaging	Minimum Quantity
L	ø180mm Embossed Taping	2000

### Rated Value (□: packaging code)

Part Number		Inductance	Inductance Test Frequency	Rated Current (I <sub>sat</sub> )*	Rated Current (I <sub>temp</sub> )*	DC Resistance	S.R.F.* (min.)
Infotainment	Powertrain/Safety						
LQH3NPZ1R0MME□	LQH3NPH1R0MME□	1μH ±20%	1MHz	2350mA	3000mA(Ambient temp.85°C) 1600mA(Ambient temp.105°C)	0.025Ω±20%	100MHz
LQH3NPZ2R2MME□	LQH3NPH2R2MME□	2.2μH ±20%	1MHz	1800mA	2100mA(Ambient temp.85°C) 1220mA(Ambient temp.105°C)	0.065Ω±20%	60MHz
LQH3NPZ3R3MME□	LQH3NPH3R3MME□	3.3μH ±20%	1MHz	1520mA	1900mA(Ambient temp.85°C) 1150mA(Ambient temp.105°C)	0.084Ω±20%	55MHz
LQH3NPZ4R7MME□	LQH3NPH4R7MME□	4.7μH ±20%	1MHz	1300mA	1700mA(Ambient temp.85°C) 1000mA(Ambient temp.105°C)	0.10Ω±20%/0.1Ω±20%	40MHz
LQH3NPZ6R8MME□	LQH3NPH6R8MME□	6.8μH ±20%	1MHz	1040mA	1450mA(Ambient temp.85°C) 900mA(Ambient temp.105°C)	0.14Ω±20%	30MHz
LQH3NPZ100MME□	LQH3NPH100MME□	10μH ±20%	1MHz	810mA	1280mA(Ambient temp.85°C) 800mA(Ambient temp.105°C)	0.19Ω±20%	20MHz
LQH3NPZ150MME□	LQH3NPH150MME□	15μH ±20%	1MHz	660mA	1020mA(Ambient temp.85°C) 620mA(Ambient temp.105°C)	0.29Ω±20%	15MHz
LQH3NPZ220MME□	LQH3NPH220MME□	22μH ±20%	1MHz	570mA	860mA(Ambient temp.85°C) 540mA(Ambient temp.105°C)	0.40Ω±20%/0.4Ω±20%	10MHz
LQH3NPZ330MME□	LQH3NPH330MME□	33μH ±20%	1MHz	440mA	760mA(Ambient temp.85°C) 460mA(Ambient temp.105°C)	0.55Ω±20%	8MHz
LQH3NPZ470MME□	LQH3NPH470MME□	47μH ±20%	1MHz	380mA	610mA(Ambient temp.85°C) 380mA(Ambient temp.105°C)	0.82Ω±20%	5MHz

Operating temp.range (Self-temp.rise included): -40 to 125°C

Operating temp.range (Self-temp.rise not included): -40 to 105°C

Class of Magnetic Shield: Magnetic Resin

Only for reflow soldering

\*I<sub>sat</sub>: Rated Current based on Inductance change

\*I<sub>temp</sub>: Rated Current based on Temperature rise

\*S.R.F.: Self Resonant Frequency

When rated current is applied to the products, inductance will be within ±30% of initial inductance value range. Keep the temperature (ambient temperature plus self-generation of heat) under 125°C. When rated current is applied to the products, temperature rise caused by self-generated heat shall be limited to 40°C max (ambient temperature 85°C max). When rated current is applied to the products, temperature rise caused by self-generated heat shall be limited to 20°C max (ambient temperature 85°C to 105°C)./When rated current is applied to the products, inductance will be within ±30% of initial inductance value range. Keep the temperature (ambient temperature plus self-generation of heat) under 125°C. When rated current is applied to the products, the self-temperature rise shall be limited to 40°C max. (ambient temperature 85°C). When rated current is applied to the products, the self-temperature rise shall be limited to 20°C max. (ambient temperature 85°C to 105°C).

Continued on the following page. ↗



Continued from the preceding page. ↘

Part Number		Inductance	Inductance Test Frequency	Rated Current (Isat)*	Rated Current (Itemp)*	DC Resistance	S.R.F* (min.)
Infotainment	Powertrain/Safety						
LQH3NPZ560MME□	LQH3NPH560MME□	56μH ±20%	1MHz	350mA	500mA(Ambient temp.85°C) 320mA(Ambient temp.105°C)	1.0Ω±20%/1Ω±20%	5MHz
LQH3NPZ680MME□	LQH3NPH680MME□	68μH ±20%	1MHz	310mA	470mA(Ambient temp.85°C) 300mA(Ambient temp.105°C)	1.15Ω±20%	5MHz
LQH3NPZ101MME□	LQH3NPH101MME□	100μH ±20%	1MHz	260mA	430mA(Ambient temp.85°C) 270mA(Ambient temp.105°C)	1.59Ω±20%	3MHz

Operating temp.range (Self-temp.rise included): -40 to 125°C  
 Operating temp.range (Self-temp.rise not included): -40 to 105°C  
 Class of Magnetic Shield: Magnetic Resin  
 Only for reflow soldering  
 \*Isat: Rated Current based on Inductance change  
 \*Itemp: Rated Current based on Temperature rise  
 \*S.R.F: Self Resonant Frequency

When rated current is applied to the products, inductance will be within ±30% of initial inductance value range. Keep the temperature (ambient temperature plus self-generation of heat) under 125°C. When rated current is applied to the products, temperature rise caused by self-generated heat shall be limited to 40°C max (ambient temperature 85°C max). When rated current is applied to the products, inductance will be within ±30% of initial inductance value range. Keep the temperature (ambient temperature plus self-generation of heat) under 125°C. When rated current is applied to the products, the self-temperature rise shall be limited to 40°C max. (ambient temperature 85°C). When rated current is applied to the products, the self-temperature rise shall be limited to 20°C max. (ambient temperature 85°C to 105°C).

### Inductance-Frequency Characteristics (Typ.)

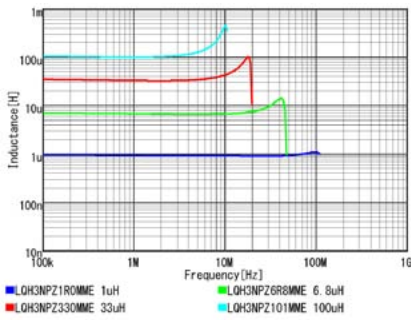

### Inductance-Current Characteristics (Typ.)

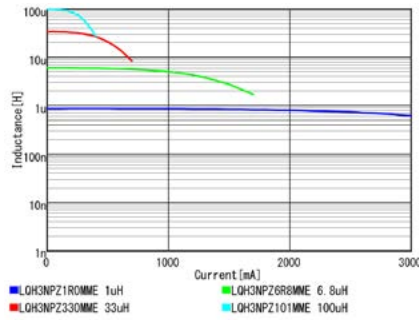

### Temperature Rise Characteristics (Typ.)

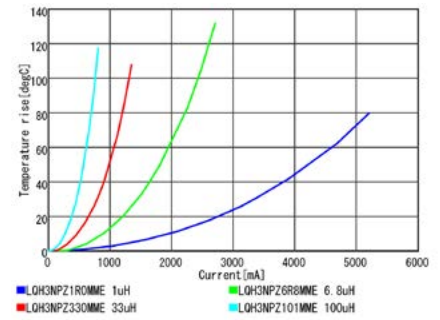



## Inductors for Power Lines

# LQH32PZ\_N0/LQH32PH\_N0 Series 1210 (3225) inch (mm)

### Specifications Sheet (with cautions/mounting/packaging)

Infotainment	<a href="https://search.murata.co.jp/Ceramy/image/img/P02/JELF243A-9123.pdf">https://search.murata.co.jp/Ceramy/image/img/P02/JELF243A-9123.pdf</a>
Powertrain/Safety	<a href="https://search.murata.co.jp/Ceramy/image/img/P02/JELF243A-9136.pdf">https://search.murata.co.jp/Ceramy/image/img/P02/JELF243A-9136.pdf</a>

### Appearance/Dimensions

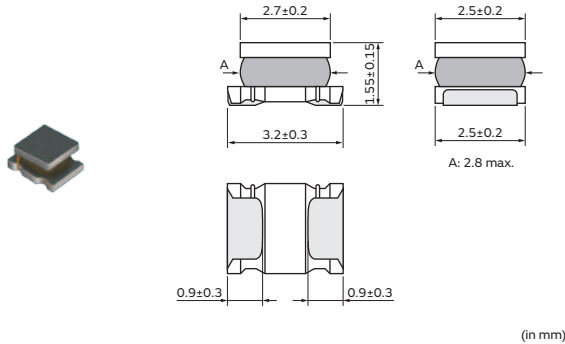

### Packaging

Code	Packaging	Minimum Quantity
K	ø330mm Embossed Taping	7500
L	ø180mm Embossed Taping	2000

### Rated Value (□: packaging code)

Part Number		Inductance	Inductance Test Frequency	Rated Current (Isat)*	Rated Current (Itemp)*	DC Resistance	S.R.F.* (min.)
Infotainment	Powertrain/Safety						
LQH32PZR47NNO□	LQH32PHR47NNO□	0.47μH ±30%	1MHz	3400mA	2550mA(Ambient temp.85°C) 1600mA(Ambient temp.105°C)	0.030Ω±20%	100MHz
LQH32PZ1R0NNO□	LQH32PH1R0NNO□	1μH ±30%	1MHz	2300mA	2050mA(Ambient temp.85°C) 1320mA(Ambient temp.105°C)	0.045Ω±20%	100MHz
LQH32PZ1R5NNO□	LQH32PH1R5NNO□	1.5μH ±30%	1MHz	1750mA	1750mA(Ambient temp.85°C) 1010mA(Ambient temp.105°C)	0.057Ω±20%	70MHz
LQH32PZ2R2NNO□	LQH32PH2R2NNO□	2.2μH ±30%	1MHz	1550mA	1600mA(Ambient temp.85°C) 970mA(Ambient temp.105°C)	0.076Ω±20%	70MHz
LQH32PZ3R3NNO□	LQH32PH3R3NNO□	3.3μH ±30%	1MHz	1250mA	1200mA(Ambient temp.85°C) 670mA(Ambient temp.105°C)	0.12Ω±20%	50MHz
LQH32PZ4R7NNO□	LQH32PH4R7NNO□	4.7μH ±30%	1MHz	1000mA	1000mA(Ambient temp.85°C) 530mA(Ambient temp.105°C)	0.18Ω±20%	40MHz
LQH32PZ6R8NNO□	LQH32PH6R8NNO□	6.8μH ±30%	1MHz	850mA	850mA(Ambient temp.85°C) 510mA(Ambient temp.105°C)	0.24Ω±20%	40MHz
LQH32PZ100MNO□	LQH32PH100MNO□	10μH ±20%	1MHz	750mA	700mA(Ambient temp.85°C) 380mA(Ambient temp.105°C)	0.38Ω±20%	30MHz
LQH32PZ150MNO□	—	15μH ±20%	1MHz	600mA	520mA(Ambient temp.85°C) 320mA(Ambient temp.105°C)	0.57Ω±20%	20MHz
LQH32PZ220MNO□	—	22μH ±20%	1MHz	500mA	450mA(Ambient temp.85°C) 240mA(Ambient temp.105°C)	0.81Ω±20%	20MHz
LQH32PZ330MNO□	—	33μH ±20%	1MHz	380mA	390mA(Ambient temp.85°C) 190mA(Ambient temp.105°C)	1.15Ω±20%	13MHz

Operating temp.range (Self-temp.rise included): -40 to 125°C  
 Operating temp.range (Self-temp.rise not included): -40 to 105°C  
 Class of Magnetic Shield: Magnetic Resin  
 Only for reflow soldering

\*Isat: Rated Current based on Inductance change

\*Itemp: Rated Current based on Temperature rise

\*S.R.F: Self Resonant Frequency

When rated current is applied to the products, inductance will be within ±30% of nominal inductance value. When rated current is applied to the products, temperature rise caused by self-generated heat shall be limited to 40°C max(ambient temperature 85°C max). When rated current is applied to the products, temperature rise caused by self-generated heat shall be limited to 20°C max(ambient temperature 85°C to 105°C). Keep the temperature (ambient temperature plus self-generation of heat) under 125°C.

Continued on the following page. ↗

Continued from the preceding page. ↘

Part Number		Inductance	Inductance Test Frequency	Rated Current (Isat)*	Rated Current (Itemp)*	DC Resistance	S.R.F* (min.)
Infotainment	Powertrain/Safety						
LQH32PZ470MN0□	—	47μH ±20%	1MHz	330mA	310mA(Ambient temp.85°C) 140mA(Ambient temp.105°C)	1.78Ω±20%	11MHz
LQH32PZ680MN0□	—	68μH ±20%	1MHz	280mA	275mA(Ambient temp.85°C) 120mA(Ambient temp.105°C)	2.28Ω±20%	11MHz
LQH32PZ101MN0□	—	100μH ±20%	1MHz	180mA	250mA(Ambient temp.85°C) 110mA(Ambient temp.105°C)	2.70Ω±20%	8MHz
LQH32PZ121MN0□	—	120μH ±20%	1MHz	170mA	200mA(Ambient temp.85°C) 80mA(Ambient temp.105°C)	4.38Ω±20%	8MHz

Operating temp.range (Self-temp.rise included): -40 to 125°C  
 Operating temp.range (Self-temp.rise not included): -40 to 105°C  
 Class of Magnetic Shield: Magnetic Resin  
 Only for reflow soldering

\*Isat: Rated Current based on Inductance change  
 \*Itemp: Rated Current based on Temperature rise  
 \*S.R.F: Self Resonant Frequency

When rated current is applied to the products, inductance will be within ±30% of nominal inductance value. When rated current is applied to the products, temperature rise caused by self-generated heat shall be limited to 40°C max(ambient temperature 85°C max). When rated current is applied to the products, temperature rise caused by self-generated heat shall be limited to 20°C max(ambient temperature 85°C to 105°C). Keep the temperature (ambient temperature plus self-generation of heat) under 125°C.

### Inductance-Frequency Characteristics (Typ.)

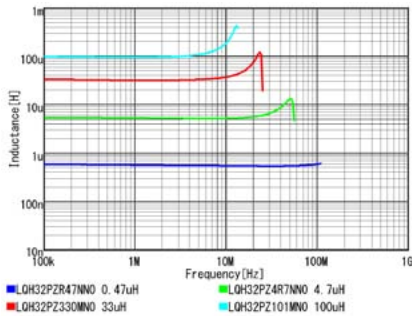

### Inductance-Current Characteristics (Typ.)

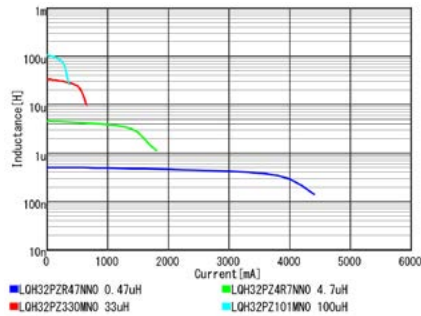

### Temperature Rise Characteristics (Typ.)

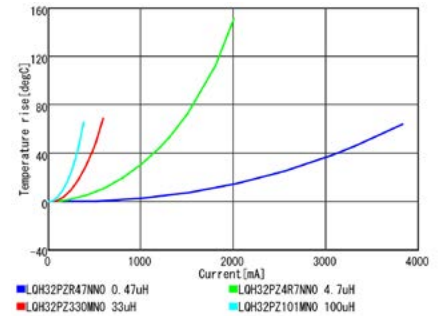

## Inductors for Power Lines

# LQH32PZ\_NC/LQH32PH\_NC Series 1210 (3225) inch (mm)

### Specifications Sheet (with cautions/mounting/packaging)

Infotainment	<a href="https://search.murata.co.jp/Ceramy/image/img/P02/JELF243A-9124.pdf">https://search.murata.co.jp/Ceramy/image/img/P02/JELF243A-9124.pdf</a>
Powertrain/Safety	<a href="https://search.murata.co.jp/Ceramy/image/img/P02/JELF243A-9135.pdf">https://search.murata.co.jp/Ceramy/image/img/P02/JELF243A-9135.pdf</a>

### Appearance/Dimensions

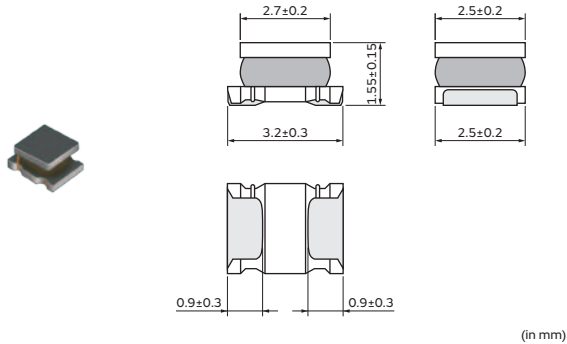

### Packaging

Code	Packaging	Minimum Quantity
K	ø330mm Embossed Taping	7500
L	ø180mm Embossed Taping	2000

### Rated Value (□: packaging code)

Part Number		Inductance	Inductance Test Frequency	Rated Current (Isat)*	Rated Current (Itemp)*	DC Resistance	S.R.F* (min.)
Infotainment	Powertrain/Safety						
LQH32PZR47NNC□	LQH32PHR47NNC□	0.47μH ±30%	1MHz	4400mA	2900mA(Ambient temp.85°C) 1490mA(Ambient temp.105°C)	0.024Ω±20%	100MHz
LQH32PZ1R0NNC□	LQH32PH1R0NNC□	1μH ±30%	1MHz	3000mA	2500mA(Ambient temp.85°C) 1380mA(Ambient temp.105°C)	0.036Ω±20%	100MHz
LQH32PZ1R5NNC□	LQH32PH1R5NNC□	1.5μH ±30%	1MHz	2600mA	2100mA(Ambient temp.85°C) 1110mA(Ambient temp.105°C)	0.053Ω±20%	70MHz
LQH32PZ2R2NNC□	LQH32PH2R2NNC□	2.2μH ±30%	1MHz	2000mA	1850mA(Ambient temp.85°C) 910mA(Ambient temp.105°C)	0.064Ω±20%	70MHz
LQH32PZ3R3NNC□	LQH32PH3R3NNC□	3.3μH ±30%	1MHz	1900mA	1550mA(Ambient temp.85°C) 800mA(Ambient temp.105°C)	0.100Ω±20%	50MHz
LQH32PZ4R7NNC□	LQH32PH4R7NNC□	4.7μH ±30%	1MHz	1600mA	1200mA(Ambient temp.85°C) 610mA(Ambient temp.105°C)	0.155Ω±20%	40MHz
LQH32PZ6R8NNC□	LQH32PH6R8NNC□	6.8μH ±30%	1MHz	1300mA	1100mA(Ambient temp.85°C) 550mA(Ambient temp.105°C)	0.220Ω±20%	40MHz
LQH32PZ100MNC□	LQH32PH100MNC□	10μH ±20%	1MHz	1000mA	900mA(Ambient temp.85°C) 450mA(Ambient temp.105°C)	0.295Ω±20%	30MHz
LQH32PZ150MNC□	LQH32PH150MNC□	15μH ±20%	1MHz	800mA	700mA(Ambient temp.85°C) 330mA(Ambient temp.105°C)	0.475Ω±20%	20MHz
LQH32PZ220MNC□	LQH32PH220MNC□	22μH ±20%	1MHz	650mA	550mA(Ambient temp.85°C) 270mA(Ambient temp.105°C)	0.685Ω±20%	20MHz

Operating temp.range (Self-temp.rise included): -40 to 125°C  
 Operating temp.range (Self-temp.rise not included): -40 to 105°C  
 Class of Magnetic Shield: Magnetic Resin

Only for reflow soldering

\*Isat: Rated Current based on Inductance change

\*Itemp: Rated Current based on Temperature rise

\*S.R.F: Self Resonant Frequency

When rated current is applied to the products, inductance will be within ±30% of nominal inductance value. When rated current is applied to the products, temperature rise caused by self-generated heat shall be limited to 40°C max (ambient temperature 85°C max). When rated current is applied to the products, temperature rise caused by self-generated heat shall be limited to 20°C max (ambient temperature 85°C to 105°C). Keep the temperature (ambient temperature plus self-generation of heat) under 125°C./When rated current is applied to the products, inductance will be within ±30% of nominal inductance value. When rated current is applied to the products, temperature rise caused by self-generated heat shall be limited to 40°C max(ambient temperature 85°C max). When rated current is applied to the products, temperature rise caused by self-generated heat shall be limited to 20°C max(ambient temperature 85°C to 105°C). Keep the temperature (ambient temperature plus self-generation of heat) under 125°C.

Continued on the following page. ↗

Continued from the preceding page. ↘

### Inductance-Frequency Characteristics (Typ.)

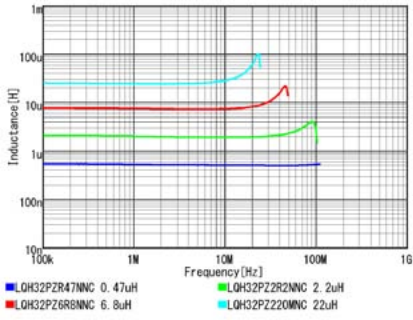

### Inductance-Current Characteristics (Typ.)

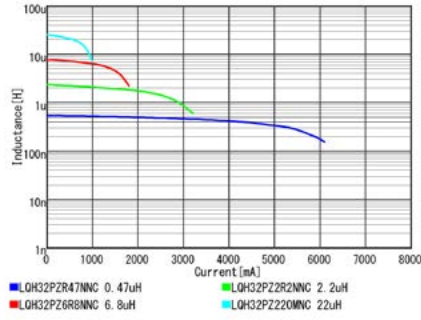

### Temperature Rise Characteristics (Typ.)

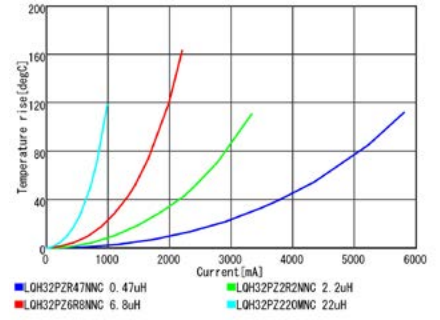

Chip Ferrite Bead  
 Chip EMIFIL  
 Chip Common Mode Choke Coil  
 Block Type EMIFIL  
 Microchip Transformer (Balun)  
 Inductors for Power Lines  
 Inductors for General Circuits  
 RF Inductors

# Inductors for Power Lines

## LQH32DZ\_23 Series 1210 (3225) inch (mm)

### Specifications Sheet (with cautions/mounting/packaging)

Infotainment	<a href="https://search.murata.co.jp/Ceramy/image/img/P02/JELF243A-9028.pdf">https://search.murata.co.jp/Ceramy/image/img/P02/JELF243A-9028.pdf</a>
Powertrain/Safety	—

### Appearance/Dimensions

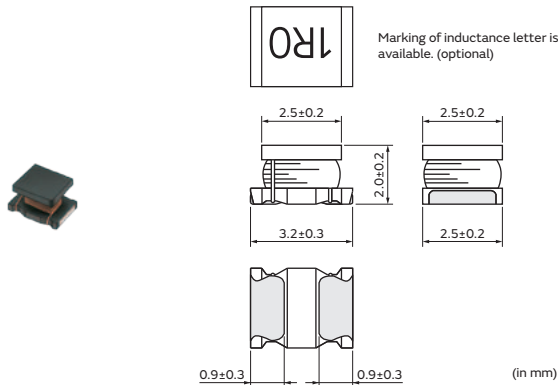

### Packaging

Code	Packaging	Minimum Quantity
K	ø330mm Embossed Taping	7500
L	ø180mm Embossed Taping	2000

### Rated Value (□: packaging code)

Part Number		Inductance	Inductance Test Frequency	Rated Current	DC Resistance	S.R.F.* (min.)
Infotainment	Powertrain/Safety					
LQH32DZ1R0M23□	—	1μH ±20%	1MHz	800mA	0.09Ω±30%	96MHz
LQH32DZ2R2M23□	—	2.2μH ±20%	1MHz	600mA	0.13Ω±30%	64MHz
LQH32DZ3R3M23□	—	3.3μH ±20%	1MHz	530mA	0.20Ω±30%	50MHz
LQH32DZ4R7M23□	—	4.7μH ±20%	1MHz	450mA	0.20Ω±30%	43MHz
LQH32DZ100K23□	—	10μH ±10%	1MHz	300mA	0.44Ω±30%	26MHz
LQH32DZ220K23□	—	22μH ±10%	1MHz	250mA	0.71Ω±30%	19MHz
LQH32DZ390K23□	—	39μH ±10%	1MHz	200mA	1.2Ω±30%	16MHz
LQH32DZ470K23□	—	47μH ±10%	1MHz	170mA	1.3Ω±30%	15MHz
LQH32DZ680K23□	—	68μH ±10%	1MHz	130mA	2.2Ω±30%	12MHz
LQH32DZ101K23□	—	100μH ±10%	1MHz	100mA	3.5Ω±30%	10MHz
LQH32DZ151K23□	—	150μH ±10%	1MHz	80mA	5.1Ω±30%	8MHz
LQH32DZ221K23□	—	220μH ±10%	1MHz	70mA	8.4Ω±30%	6.8MHz
LQH32DZ331K23□	—	330μH ±10%	1MHz	60mA	10.0Ω±30%	5.6MHz
LQH32DZ391K23□	—	390μH ±10%	1MHz	60mA	12.4Ω±30%	5MHz
LQH32DZ471K23□	—	470μH ±10%	1kHz	60mA	14.1Ω±30%	5MHz

Operating temp.range: -40 to 105°C

Class of Magnetic Shield: No Shield

Only for reflow soldering

\*S.R.F.: Self Resonant Frequency

When rated current is applied to the products, self-temperature rise shall be limited to 20°C max and inductance will be within ±10% of initial inductance value.

### Inductance-Frequency Characteristics (Typ.)

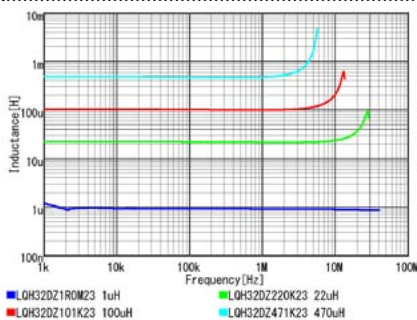

### Inductance-Current Characteristics (Typ.)

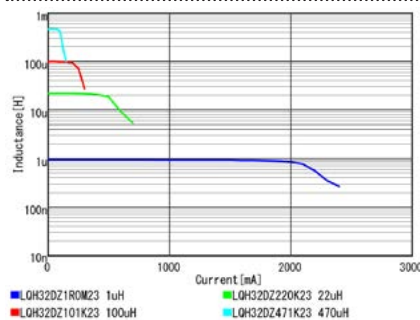

### Impedance-Frequency Characteristics (Typ.)

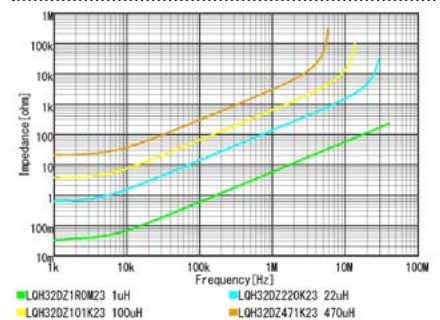

# Inductors for Power Lines

## LQH32DZ\_53 Series 1210 (3225) inch (mm)

### Specifications Sheet (with cautions/mounting/packaging)

Infotainment	<a href="https://search.murata.co.jp/Ceramy/image/img/P02/JELF243A-9019.pdf">https://search.murata.co.jp/Ceramy/image/img/P02/JELF243A-9019.pdf</a>
Powertrain/Safety	—

### Appearance/Dimensions

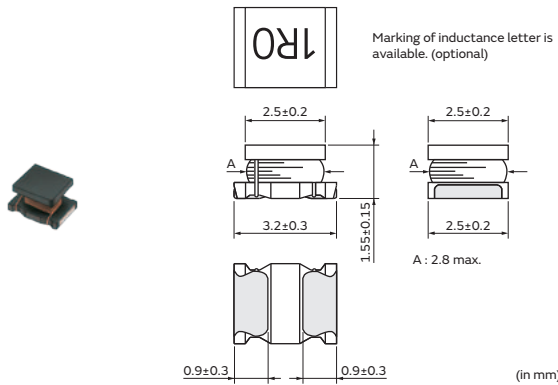

### Packaging

Code	Packaging	Minimum Quantity
K	ø330mm Embossed Taping	7500
L	ø180mm Embossed Taping	2000

### Rated Value (□: packaging code)

Part Number		Inductance	Inductance Test Frequency	Rated Current	DC Resistance	S.R.F* (min.)
Infotainment	Powertrain/Safety					
LQH32DZ1R0M53□	—	1μH ±20%	1MHz	1000mA	0.060Ω±30%	100MHz
LQH32DZ2R2M53□	—	2.2μH ±20%	1MHz	790mA	0.097Ω±30%	64MHz
LQH32DZ3R3M53□	—	3.3μH ±20%	1MHz	710mA	0.12Ω±30%	50MHz
LQH32DZ4R7M53□	—	4.7μH ±20%	1MHz	650mA	0.15Ω±30%	43MHz
LQH32DZ6R8M53□	—	6.8μH ±20%	1MHz	540mA	0.25Ω±30%	32MHz
LQH32DZ100K53□	—	10μH ±10%	1MHz	450mA	0.30Ω±30%	26MHz
LQH32DZ150K53□	—	15μH ±10%	1MHz	300mA	0.58Ω±30%	26MHz
LQH32DZ220K53□	—	22μH ±10%	1MHz	250mA	0.71Ω±30%	19MHz
LQH32DZ330K53□	—	33μH ±10%	1MHz	200mA	1.1Ω±30%	17MHz
LQH32DZ470K53□	—	47μH ±10%	1MHz	170mA	1.3Ω±30%	15MHz
LQH32DZ680K53□	—	68μH ±10%	1MHz	130mA	2.2Ω±30%	12MHz
LQH32DZ101K53□	—	100μH ±10%	1MHz	100mA	3.5Ω±30%	10MHz

Operating temp.range: -40 to 105°C

Class of Magnetic Shield: No Shield

Only for reflow soldering

\*S.R.F: Self Resonant Frequency

When rated current is applied to the products, self-temperature rise shall be limited to 20°C max and inductance will be within ±10% of initial inductance value.

### Inductance-Frequency Characteristics (Typ.)

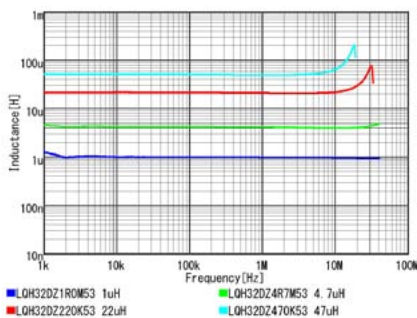

### Inductance-Current Characteristics (Typ.)

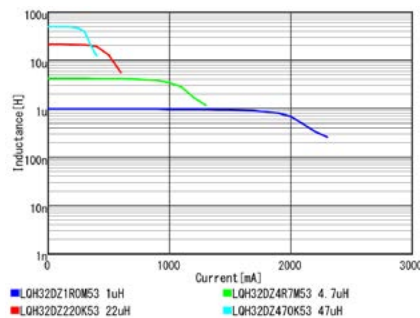

### Impedance-Frequency Characteristics (Typ.)

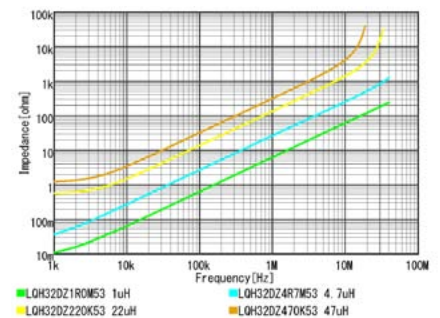



# Inductors for Power Lines

## LQH32CH\_23 Series 1210 (3225) inch (mm)

### Specifications Sheet (with cautions/mounting/packaging)

Infotainment	—
Powertrain/Safety	<a href="https://search.murata.co.jp/Ceramy/image/img/P02/JELF243A-9111.pdf">https://search.murata.co.jp/Ceramy/image/img/P02/JELF243A-9111.pdf</a>

### Appearance/Dimensions

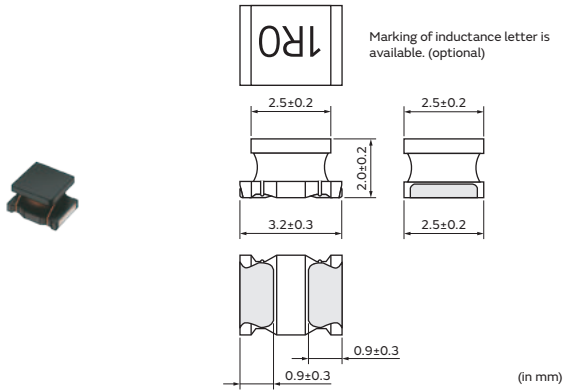

### Packaging

Code	Packaging	Minimum Quantity
K	ø330mm Embossed Taping	7500
L	ø180mm Embossed Taping	2000
B	Packing in Bulk	500

### Rated Value (□: packaging code)

Part Number		Inductance	Inductance Test Frequency	Rated Current	DC Resistance	S.R.F* (min.)
Infotainment	Powertrain/Safety					
—	LQH32CH1R0M23□	1μH ±20%	1MHz	800mA	0.09Ω±30%	96MHz
—	LQH32CH2R2M23□	2.2μH ±20%	1MHz	600mA	0.13Ω±30%	64MHz
—	LQH32CH4R7M23□	4.7μH ±20%	1MHz	450mA	0.20Ω±30%	43MHz
—	LQH32CH100K23□	10μH ±10%	1MHz	300mA	0.44Ω±30%	26MHz
—	LQH32CH220K23□	22μH ±10%	1MHz	250mA	0.71Ω±30%	19MHz

Operating temp.range (Self-temp.rise not included): -40 to 85°C

Class of Magnetic Shield: No Shield

\*S.R.F: Self Resonant Frequency

When rated current is applied to the products, self-temperature rise shall be limited to 20°C max and inductance will be within ±10% of initial inductance value.

### Inductance-Frequency Characteristics (Typ.)

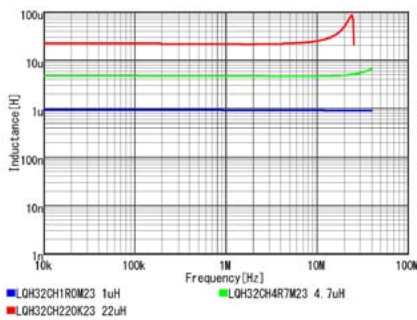

### Inductance-Current Characteristics (Typ.)

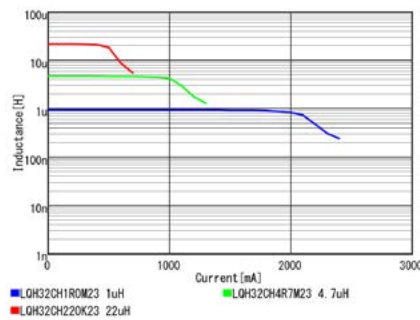

### Impedance-Frequency Characteristics (Typ.)

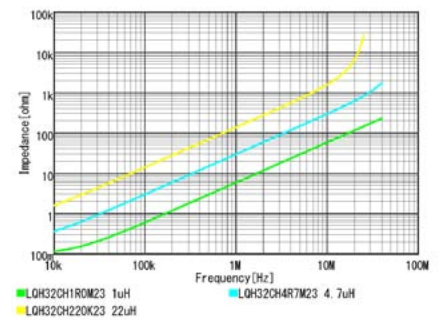

Chip Ferrite Bead

Chip EMIFIL

Chip Common Mode Choke Coil

Block Type EMIFIL

Microchip Transformer (Balun)

Inductors for Power Lines

Inductors for General Circuits

RF Inductors

# Inductors for Power Lines

## LQH32CH\_33 Series 1210 (3225) inch (mm)

### Specifications Sheet (with cautions/mounting/packaging)

Infotainment	—
Powertrain/Safety	<a href="https://search.murata.co.jp/Ceramy/image/img/P02/JELF243A-9121.pdf">https://search.murata.co.jp/Ceramy/image/img/P02/JELF243A-9121.pdf</a>

### Appearance/Dimensions

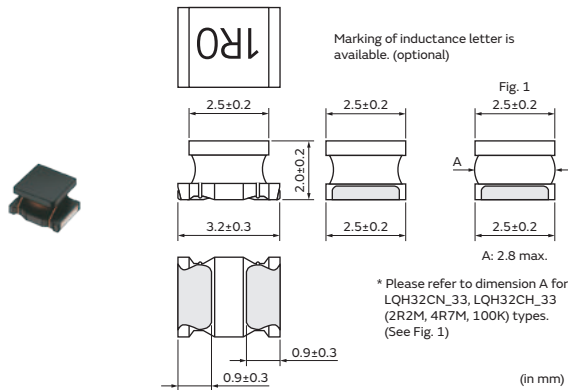

### Packaging

Code	Packaging	Minimum Quantity
K	ø330mm Embossed Taping	7500
L	ø180mm Embossed Taping	2000
B	Packing in Bulk	500

### Rated Value (□: packaging code)

Part Number		Inductance	Inductance Test Frequency	Rated Current	DC Resistance	S.R.F* (min.)
Infotainment	Powertrain/Safety					
—	LQH32CHR15M33□	0.15μH ±20%	1MHz	1450mA	0.028Ω±30%	400MHz
—	LQH32CHR27M33□	0.27μH ±20%	1MHz	1250mA	0.034Ω±30%	250MHz
—	LQH32CHR47M33□	0.47μH ±20%	1MHz	1100mA	0.042Ω±30%	150MHz
—	LQH32CH1R0M33□	1μH ±20%	1MHz	1000mA	0.060Ω±30%	100MHz
—	LQH32CH2R2M33□	2.2μH ±20%	1MHz	790mA	0.097Ω±30%	64MHz
—	LQH32CH4R7M33□	4.7μH ±20%	1MHz	650mA	0.15Ω±30%	43MHz
—	LQH32CH100K33□	10μH ±10%	1MHz	450mA	0.30Ω±30%	26MHz

Operating temp.range (Self-temp.rise not included): -40 to 85°C

Class of Magnetic Shield: No Shield

\*S.R.F: Self Resonant Frequency

When rated current is applied to the products, self-temperature rise shall be limited to 20°C max and inductance will be within ±10% of initial inductance value.

### Inductance-Frequency Characteristics (Typ.)

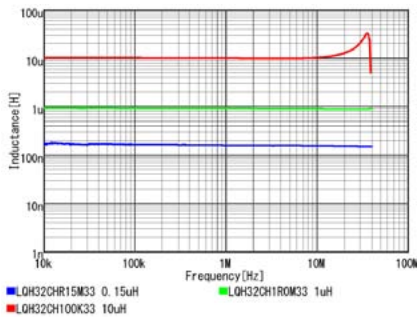

### Inductance-Current Characteristics (Typ.)

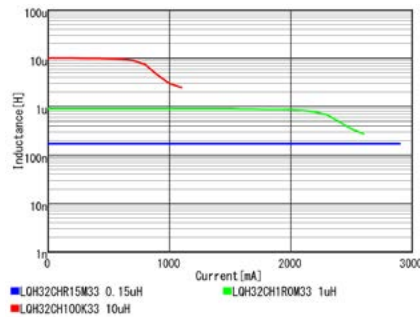

### Impedance-Frequency Characteristics (Typ.)

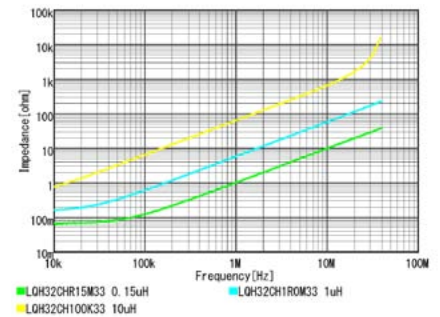



# Inductors for Power Lines

## LQH32CH\_53 Series 1210 (3225) inch (mm)

### Specifications Sheet (with cautions/mounting/packaging)

Infotainment	—
Powertrain/Safety	<a href="https://search.murata.co.jp/Ceramy/image/img/P02/JELF243A-9106.pdf">https://search.murata.co.jp/Ceramy/image/img/P02/JELF243A-9106.pdf</a>

### Appearance/Dimensions

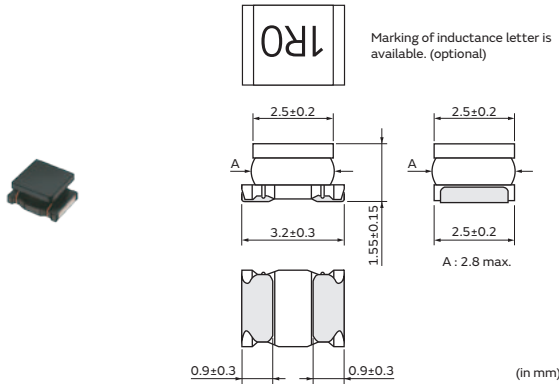

### Packaging

Code	Packaging	Minimum Quantity
K	ø330mm Embossed Taping	7500
L	ø180mm Embossed Taping	2000
B	Packing in Bulk	500

### Rated Value (□: packaging code)

Part Number		Inductance	Inductance Test Frequency	Rated Current	DC Resistance	S.R.F* (min.)
Infotainment	Powertrain/Safety					
—	LQH32CH1R0M53□	1μH ±20%	1MHz	1000mA	0.060Ω±30%	100MHz
—	LQH32CH2R2M53□	2.2μH ±20%	1MHz	790mA	0.097Ω±30%	64MHz
—	LQH32CH3R3M53□	3.3μH ±20%	1MHz	710mA	0.12Ω±30%	50MHz
—	LQH32CH4R7M53□	4.7μH ±20%	1MHz	650mA	0.15Ω±30%	43MHz
—	LQH32CH6R8M53□	6.8μH ±20%	1MHz	540mA	0.25Ω±30%	32MHz
—	LQH32CH100K53□	10μH ±10%	1MHz	450mA	0.30Ω±30%	26MHz
—	LQH32CH150K53□	15μH ±10%	1MHz	300mA	0.58Ω±30%	26MHz
—	LQH32CH220K53□	22μH ±10%	1MHz	250mA	0.71Ω±30%	19MHz

Operating temp.range (Self-temp.rise not included): -40 to 85°C

Class of Magnetic Shield: No Shield

\*S.R.F: Self Resonant Frequency

When rated current is applied to the products, self-temperature rise shall be limited to 20°C max and inductance will be within ±10% of initial inductance value.

### Inductance-Frequency Characteristics (Typ.)

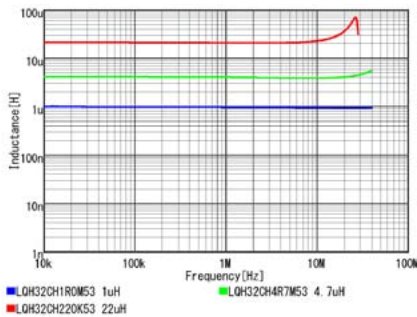

### Inductance-Current Characteristics (Typ.)

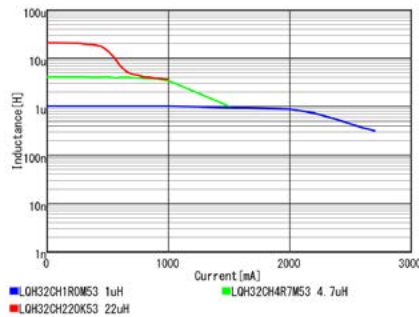

### Impedance-Frequency Characteristics (Typ.)

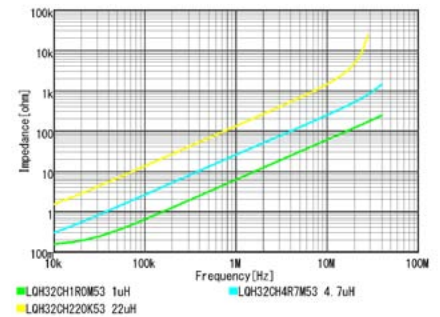

## Inductors for Power Lines

# LQH43PZ\_26/LQH43PH\_26 Series 1812 (4532) inch (mm)

### Specifications Sheet (with cautions/mounting/packaging)

Infotainment	<a href="https://search.murata.co.jp/Ceramy/image/img/P02/JELF243A-9126.pdf">https://search.murata.co.jp/Ceramy/image/img/P02/JELF243A-9126.pdf</a>
Powertrain/Safety	<a href="https://search.murata.co.jp/Ceramy/image/img/P02/JELF243A-9137.pdf">https://search.murata.co.jp/Ceramy/image/img/P02/JELF243A-9137.pdf</a>

### Appearance/Dimensions

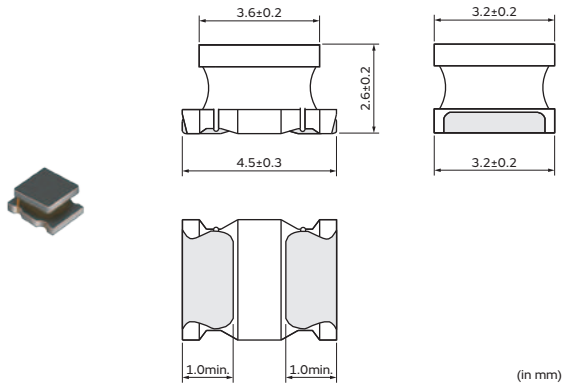

### Packaging

Code	Packaging	Minimum Quantity
K	ø330mm Embossed Taping	2500
L	ø180mm Embossed Taping	500

### Rated Value (□: packaging code)

Part Number		Inductance	Inductance Test Frequency	Rated Current (Isat)*	Rated Current (Itemp)*	DC Resistance	S.R.F.* (min.)
Infotainment	Powertrain/Safety						
LQH43PZ1R0N26□	LQH43PH1R0N26□	1μH ±30%	1MHz	3400mA	3300mA(Ambient temp.85°C) 1410mA(Ambient temp.105°C)	0.026Ω±20%	100MHz
LQH43PZ2R2M26□	LQH43PH2R2M26□	2.2μH ±20%	1MHz	2300mA	2500mA(Ambient temp.85°C) 1120mA(Ambient temp.105°C)	0.042Ω±20%	45MHz
LQH43PZ3R3M26□	LQH43PH3R3M26□	3.3μH ±20%	1MHz	1800mA	2100mA(Ambient temp.85°C) 1000mA(Ambient temp.105°C)	0.052Ω±20%	40MHz
LQH43PZ4R7M26□	LQH43PH4R7M26□	4.7μH ±20%	1MHz	1400mA	1600mA(Ambient temp.85°C) 780mA(Ambient temp.105°C)	0.075Ω±20%	35MHz
LQH43PZ6R8M26□	LQH43PH6R8M26□	6.8μH ±20%	1MHz	1200mA	1400mA(Ambient temp.85°C) 760mA(Ambient temp.105°C)	0.098Ω±20%	30MHz
LQH43PZ8R2M26□	LQH43PH8R2M26□	8.2μH ±20%	1MHz	1100mA	1300mA(Ambient temp.85°C) 670mA(Ambient temp.105°C)	0.128Ω±20%	25MHz
LQH43PZ100M26□	LQH43PH100M26□	10μH ±20%	1MHz	1050mA	1170mA(Ambient temp.85°C) 620mA(Ambient temp.105°C)	0.147Ω±20%	20MHz
LQH43PZ220M26□	LQH43PH220M26□	22μH ±20%	1MHz	700mA	780mA(Ambient temp.85°C) 400mA(Ambient temp.105°C)	0.327Ω±20%	15MHz
LQH43PZ470M26□	LQH43PH470M26□	47μH ±20%	1MHz	470mA	520mA(Ambient temp.85°C) 280mA(Ambient temp.105°C)	0.718Ω±20%	8MHz
LQH43PZ101M26□	LQH43PH101M26□	100μH ±20%	1MHz	320mA	320mA(Ambient temp.85°C) 180mA(Ambient temp.105°C)	1.538Ω±20%	4MHz
LQH43PZ151M26□	LQH43PH151M26□	150μH ±20%	1MHz	280mA	260mA(Ambient temp.85°C) 140mA(Ambient temp.105°C)	2.362Ω±20%	3MHz

Operating temp.range (Self-temp.rise included): -40 to 125°C

Operating temp.range (Self-temp.rise not included): -40 to 105°C

Class of Magnetic Shield: Magnetic Resin

Only for reflow soldering

\*Isat: Rated Current based on Inductance change

\*Itemp: Rated Current based on Temperature rise

\*S.R.F: Self Resonant Frequency

When rated current is applied to the products, inductance will be within ±30% of nominal inductance value. When rated current is applied to the products, temperature rise caused by self-generated heat shall be limited to 40°C max (ambient temperature 85°C max). When rated current is applied to the products, temperature rise caused by self-generated heat shall be limited to 20°C max (ambient temperature 85°C to 105°C). Keep the temperature (ambient temperature plus self-generation of heat) under 125°C.

Continued on the following page. ↗

Continued from the preceding page. ↘

Part Number		Inductance	Inductance Test Frequency	Rated Current (Isat)*	Rated Current (Itemp)*	DC Resistance	S.R.F.* (min.)
Infotainment	Powertrain/Safety						
LQH43PZ221M26□	LQH43PH221M26□	220μH ±20%	1MHz	220mA	240mA(Ambient temp.85°C) 130mA(Ambient temp.105°C)	2.900Ω±20%	2MHz

Operating temp.range (Self-temp.rise included): -40 to 125°C  
 Operating temp.range (Self-temp.rise not included): -40 to 105°C  
 Class of Magnetic Shield: Magnetic Resin

Only for reflow soldering

\*Isat: Rated Current based on Inductance change

\*Itemp: Rated Current based on Temperature rise

\*S.R.F.: Self Resonant Frequency

When rated current is applied to the products, inductance will be within ±30% of nominal inductance value. When rated current is applied to the products, temperature rise caused by self-generated heat shall be limited to 40°C max (ambient temperature 85°C max). When rated current is applied to the products, temperature rise caused by self-generated heat shall be limited to 20°C max (ambient temperature 85°C to 105°C). Keep the temperature (ambient temperature plus self-generation of heat) under 125°C.

### Inductance-Frequency Characteristics (Typ.)

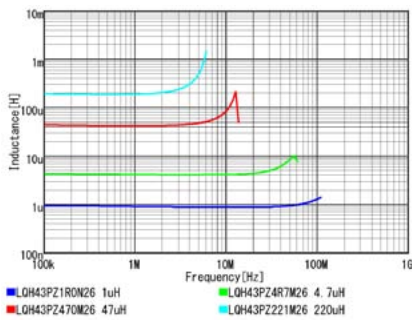

### Inductance-Current Characteristics (Typ.)

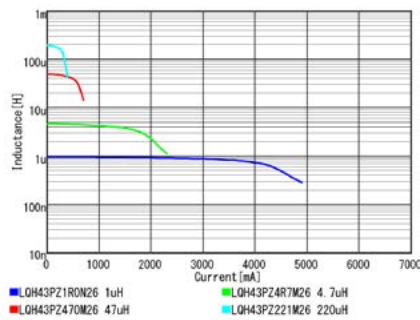

### Temperature Rise Characteristics (Typ.)

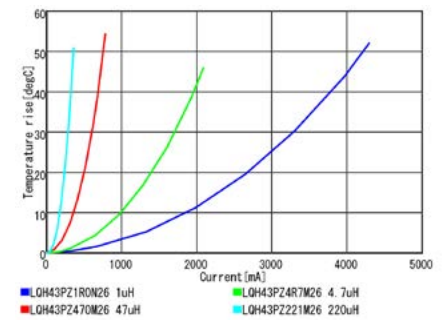

## Inductors for Power Lines

# LQH44PH\_PR Series 1515 (4040) inch (mm)

### Specifications Sheet (with cautions/mounting/packaging)

Infotainment	—
Powertrain/Safety	<a href="https://search.murata.co.jp/Ceramy/image/img/P02/JELF243A-9153.pdf">https://search.murata.co.jp/Ceramy/image/img/P02/JELF243A-9153.pdf</a>

### Appearance/Dimensions

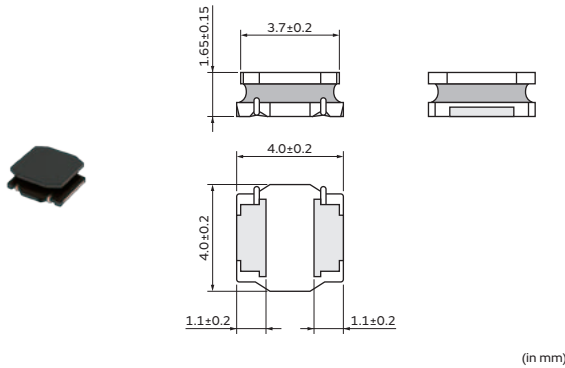

### Packaging

Code	Packaging	Minimum Quantity
L	ø180mm Embossed Taping	1000

### Rated Value (□: packaging code)

Part Number		Inductance	Inductance Test Frequency	Rated Current (Isat)*	Rated Current (Itemp)*	DC Resistance	S.R.F.* (min.)
Infotainment	Powertrain/Safety						
—	LQH44PH1R0MPR□	1μH ±20%	100kHz	4300mA	3200mA(Ambient temp.85°C) 1700mA(Ambient temp.105°C)	0.025Ω±20%	85MHz
—	LQH44PH2R2MPR□	2.2μH ±20%	100kHz	3300mA	2400mA(Ambient temp.85°C) 1450mA(Ambient temp.105°C)	0.042Ω±20%	55MHz
—	LQH44PH3R3MPR□	3.3μH ±20%	100kHz	2300mA	2000mA(Ambient temp.85°C) 1250mA(Ambient temp.105°C)	0.055Ω±20%	40MHz
—	LQH44PH4R7MPR□	4.7μH ±20%	100kHz	2050mA	1900mA(Ambient temp.85°C) 1150mA(Ambient temp.105°C)	0.065Ω±20%	40MHz
—	LQH44PH6R8MPR□	6.8μH ±20%	100kHz	1850mA	1500mA(Ambient temp.85°C) 1050mA(Ambient temp.105°C)	0.1Ω±20%	30MHz
—	LQH44PH100MPR□	10μH ±20%	100kHz	1450mA	1250mA(Ambient temp.85°C) 1000mA(Ambient temp.105°C)	0.15Ω±20%	25MHz
—	LQH44PH150MPR□	15μH ±20%	100kHz	1300mA	1100mA(Ambient temp.85°C) 750mA(Ambient temp.105°C)	0.2Ω±20%	18MHz
—	LQH44PH220MPR□	22μH ±20%	100kHz	1050mA	900mA(Ambient temp.85°C) 620mA(Ambient temp.105°C)	0.29Ω±20%	17MHz
—	LQH44PH330MPR□	33μH ±20%	100kHz	880mA	740mA(Ambient temp.85°C) 500mA(Ambient temp.105°C)	0.46Ω±20%	12MHz
—	LQH44PH470MPR□	47μH ±20%	100kHz	750mA	600mA(Ambient temp.85°C) 450mA(Ambient temp.105°C)	0.65Ω±20%	9MHz
—	LQH44PH680MPR□	68μH ±20%	100kHz	580mA	500mA(Ambient temp.85°C) 350mA(Ambient temp.105°C)	1Ω±20%	8MHz

Operating temp.range (Self-temp.rise included): -40 to 125°C

Operating temp.range (Self-temp.rise not included): -40 to 105°C

Class of Magnetic Shield: Magnetic Resin

Only for reflow soldering

\*Isat: Rated Current based on Inductance change

\*Itemp: Rated Current based on Temperature rise

\*S.R.F: Self Resonant Frequency

When rated current is applied to the products, inductance will be within ±30% of initial inductance value range. Keep the temperature (ambient temperature plus self-generation of heat) under 125°C. When rated current is applied to the products, temperature rise caused by self-generated heat shall be limited to 40°C max (ambient temperature 85°C max). When rated current is applied to the products, temperature rise caused by self-generated heat shall be limited to 20°C max (ambient temperature 85°C to 105°C).

Continued on the following page. ↗

Continued from the preceding page. ↘

Part Number		Inductance	Inductance Test Frequency	Rated Current (Isat)*	Rated Current (Itemp)*	DC Resistance	S.R.F.* (min.)
Infotainment	Powertrain/Safety						
—	LQH44PH101MPR□	100μH ±20%	100kHz	460mA	400mA(Ambient temp.85°C) 320mA(Ambient temp.105°C)	1.3Ω±20%	6MHz
—	LQH44PH151MPR□	150μH ±20%	100kHz	400mA	330mA(Ambient temp.85°C) 250mA(Ambient temp.105°C)	2.2Ω±20%	5MHz
—	LQH44PH221MPR□	220μH ±20%	100kHz	330mA	280mA(Ambient temp.85°C) 125mA(Ambient temp.105°C)	3.15Ω±20%	4MHz

Operating temp.range (Self-temp.rise included): -40 to 125°C

Operating temp.range (Self-temp.rise not included): -40 to 105°C

Class of Magnetic Shield: Magnetic Resin

Only for reflow soldering

\*Isat: Rated Current based on Inductance change

\*Itemp: Rated Current based on Temperature rise

\*S.R.F: Self Resonant Frequency

When rated current is applied to the products, inductance will be within ±30% of initial inductance value range. Keep the temperature (ambient temperature plus self-generation of heat) under 125°C. When rated current is applied to the products, temperature rise caused by self-generated heat shall be limited to 40°C max (ambient temperature 85°C max). When rated current is applied to the products, temperature rise caused by self-generated heat shall be limited to 20°C max (ambient temperature 85°C to 105°C).

### Inductance-Frequency Characteristics (Typ.)

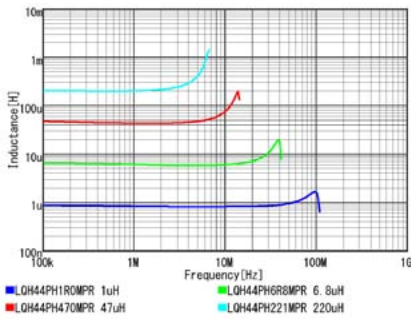

### Inductance-Current Characteristics (Typ.)

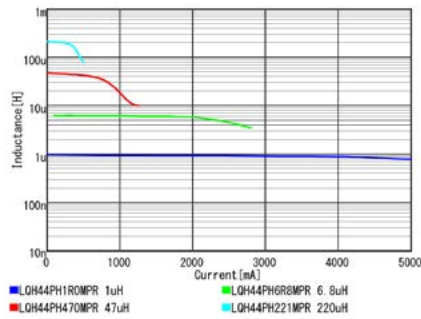

### Temperature Rise Characteristics (Typ.)

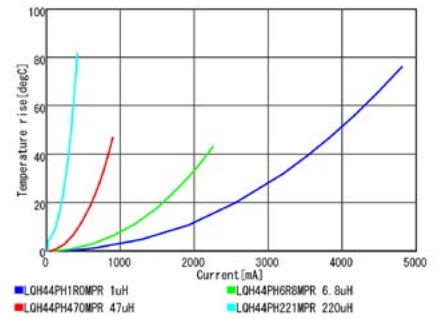

## Inductors for Power Lines

# LQH5BPZ\_T0/LQH5BPH\_T0 Series 2020 (5050) inch (mm)

### Specifications Sheet (with cautions/mounting/packaging)

Infotainment	<a href="https://search.murata.co.jp/Ceramy/image/img/P02/JELF243A-9127.pdf">https://search.murata.co.jp/Ceramy/image/img/P02/JELF243A-9127.pdf</a>
Powertrain/Safety	<a href="https://search.murata.co.jp/Ceramy/image/img/P02/JELF243A-9149.pdf">https://search.murata.co.jp/Ceramy/image/img/P02/JELF243A-9149.pdf</a>

### Appearance/Dimensions

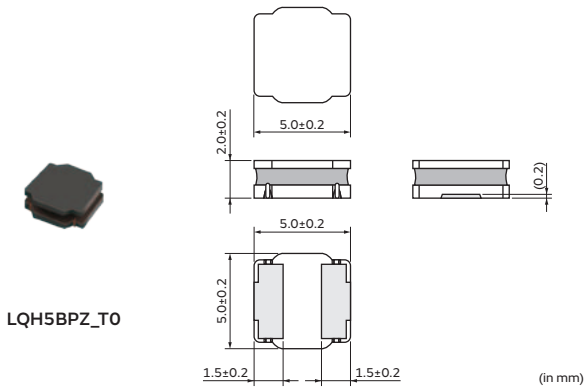

### Packaging

Code	Packaging	Minimum Quantity
K	ø330mm Embossed Taping	3000
L	ø180mm Embossed Taping	500

### Appearance/Dimensions

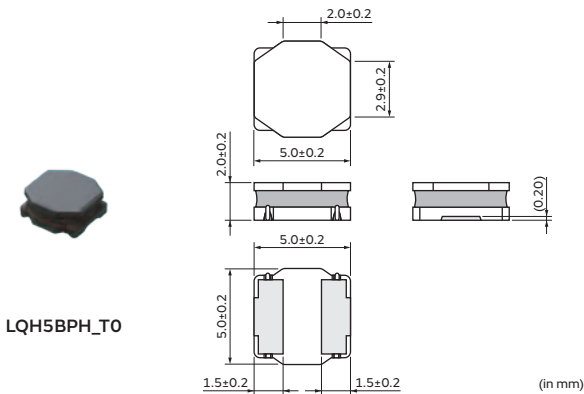

### Packaging

Code	Packaging	Minimum Quantity
K	ø330mm Embossed Taping	3000
L	ø180mm Embossed Taping	500

Continued on the following page. ↗



Continued from the preceding page. ↘

**Rated Value (□: packaging code)**

Part Number		Inductance	Inductance Test Frequency	Rated Current (Isat)*	Rated Current (Itemp)*	DC Resistance	S.R.F* (min.)	Remark
Infotainment	Powertrain/Safety							
LQH5BPZR47NT0□	LQH5BPHR47NT0□	0.47μH ±30%	100kHz	7.7A	4.0A(Ambient temp.85°C) 2.05A(Ambient temp.105°C)/4A(Ambient temp.85°C) 2.05A(Ambient temp.105°C)	0.012Ω±20%	220MHz	*1
LQH5BPZ1R0NT0□	LQH5BPH1R0NT0□	1μH ±30%	100kHz	5.8A	3.1A(Ambient temp.85°C) 1.68A(Ambient temp.105°C)	0.019Ω±20%	90MHz	*1
LQH5BPZ1R2NT0□	LQH5BPH1R2NT0□	1.2μH ±30%	100kHz	5.4A	3.1A(Ambient temp.85°C) 1.68A(Ambient temp.105°C)	0.019Ω±20%	90MHz	*1
LQH5BPZ1R5NT0□	LQH5BPH1R5NT0□	1.5μH ±30%	100kHz	5.0A/5A	3.0A(Ambient temp.85°C) 1.63A(Ambient temp.105°C)/3A(Ambient temp.85°C) 1.63A(Ambient temp.105°C)	0.024Ω±20%	70MHz	*1
LQH5BPZ2R2NT0□	LQH5BPH2R2NT0□	2.2μH ±30%	100kHz	4.0A/4A	2.6A(Ambient temp.85°C) 1.37A(Ambient temp.105°C)	0.030Ω±20%/0.03Ω±20%	55MHz	*2
LQH5BPZ2R7NT0□	LQH5BPH2R7NT0□	2.7μH ±30%	100kHz	3.8A	2.5A(Ambient temp.85°C) 1.23A(Ambient temp.105°C)	0.035Ω±20%	50MHz	*1
LQH5BPZ3R3NT0□	LQH5BPH3R3NT0□	3.3μH ±30%	100kHz	3.5A	2.3A(Ambient temp.85°C) 1.21A(Ambient temp.105°C)	0.044Ω±20%	40MHz	*1
LQH5BPZ4R7NT0□	LQH5BPH4R7NT0□	4.7μH ±30%	100kHz	3.0A/3A	2.0A(Ambient temp.85°C) 1.09A(Ambient temp.105°C)/2A(Ambient temp.85°C) 1.09A(Ambient temp.105°C)	0.058Ω±20%	40MHz	*1
LQH5BPZ6R8NT0□	LQH5BPH6R8NT0□	6.8μH ±30%	100kHz	2.5A	1.65A(Ambient temp.85°C) 0.96A(Ambient temp.105°C)	0.083Ω±20%	30MHz	*1
LQH5BPZ100MT0□	LQH5BPH100MT0□	10μH ±20%	100kHz	2.0A/2A	1.60A(Ambient temp.85°C) 0.87A(Ambient temp.105°C)/1.6A(Ambient temp.85°C) 0.87A(Ambient temp.105°C)	0.106Ω±20%	25MHz	*1
LQH5BPZ150MT0□	LQH5BPH150MT0□	15μH ±20%	100kHz	1.6A	1.20A(Ambient temp.85°C) 0.62A(Ambient temp.105°C)/1.2A(Ambient temp.85°C) 0.62A(Ambient temp.105°C)	0.187Ω±20%	18MHz	*2
LQH5BPZ220MT0□	LQH5BPH220MT0□	22μH ±20%	100kHz	1.4A	1.05A(Ambient temp.85°C) 0.55A(Ambient temp.105°C)	0.259Ω±20%	15MHz	*2
—	LQH5BPH330MT0□	33μH ±20%	100kHz	1A	0.75A(Ambient temp.85°C) 0.37A(Ambient temp.105°C)	0.43Ω±20%	6MHz	*3
—	LQH5BPH470MT0□	47μH ±20%	100kHz	0.85A	0.67A(Ambient temp.85°C) 0.35A(Ambient temp.105°C)	0.54Ω±20%	5MHz	*4

Operating temp.range (Self-temp.rise included): -40 to 125°C  
 Operating temp.range (Self-temp.rise not included): -40 to 105°C  
 Class of Magnetic Shield: Magnetic Resin  
 Only for reflow soldering

\*Isat: Rated Current based on Inductance change  
 \*Itemp: Rated Current based on Temperature rise

\*S.R.F: Self Resonant Frequency

\*1: When rated current is applied to the products, inductance will be within ±30% of initial inductance value. When rated current is applied to the products, self-temperature rise shall be limited to 40°C max. Keep the temperature (ambient temperature plus self-generation of heat) under 125°C./When rated current is applied to the products, inductance will be within ±30% of nominal inductance value. When rated current is applied to the products, temperature rise caused by self-generated heat shall be limited to 40°C max(ambient temperature 85°C max). When rated current is applied to the products, temperature rise caused by self-generated heat shall be limited to 20°C max(ambient temperature 85°C to 105°C). Keep the temperature (ambient temperature plus self-generation of heat) under 125°C.

\*2: When rated current is applied to the products, inductance will be within ±30% of initial inductance value. When rated current is applied to the products, self-temperature rise shall be limited to 40°C max. Keep the temperature (ambient temperature plus self-generation of heat) under 125°C./When rated current is applied to the products, inductance will be within ±30% of nominal inductance value. When rated current is applied to the products, the temperature rise caused by self-generated heat shall be limited to 40°C max. with outside temp under 85°C, 20°C max. with outside temp. between 85°C to 105°C

\*3: When rated current is applied to the products, inductance will be within ±30% of nominal inductance value. When rated current is applied to the products, temperature rise caused by self-generated heat shall be limited to 40°C max(ambient temperature 85°C max). When rated current is applied to the products, temperature rise caused by self-generated heat shall be limited to 20°C max(ambient temperature 85°C to 105°C). Keep the temperature (ambient temperature plus self-generation of heat) under 125°C.

\*4: When rated current is applied to the products, inductance will be within ±30% of nominal inductance value. When rated current is applied to the products, the temperature rise caused by self-generated heat shall be limited to 40°C max. with outside temp under 85°C, 20°C max. with outside temp. between 85°C to 105°C

**Inductance-Frequency Characteristics (Typ.)**

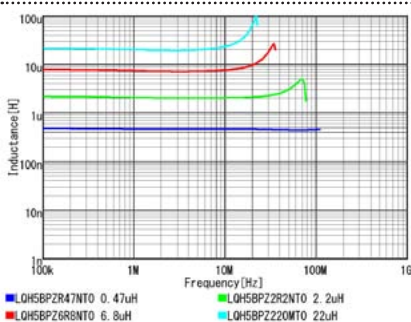

**Inductance-Current Characteristics (Typ.)**

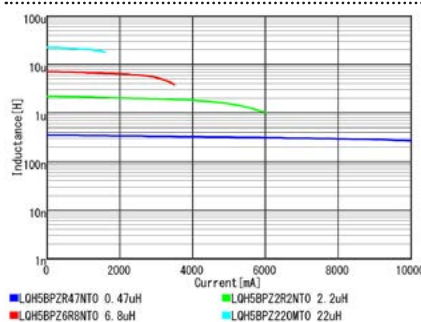

**Temperature Rise Characteristics (Typ.)**

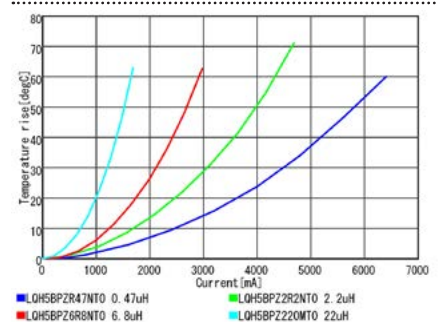

# Inductors for Power Lines

## DEM8045C\_Z Series 3131 (8080) inch (mm)

### Specifications Sheet (with cautions/mounting/packaging)

Infotainment	<a href="https://search.murata.co.jp/Ceramy/image/img/P02/J(E)TE243B-9121_DEM8045C(Z)_reference.pdf">https://search.murata.co.jp/Ceramy/image/img/P02/J(E)TE243B-9121_DEM8045C(Z)_reference.pdf</a>
Powertrain/Safety	—

### Appearance/Dimensions

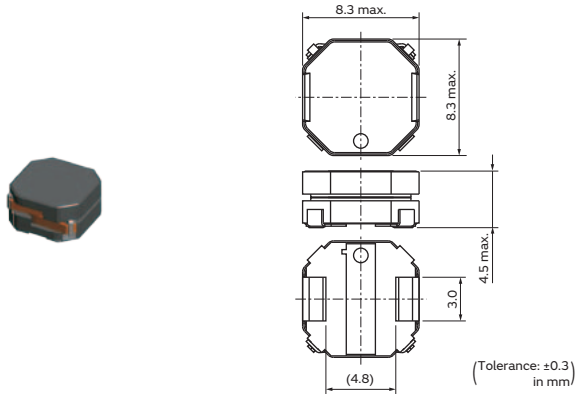

### Packaging

Code	Packaging	Minimum Quantity
=P3	ø330mm Embossed Taping	1000

### Rated Value (□: packaging code)

Part Number		Inductance	Inductance Test Frequency	Rated Current (Isat)*	Rated Current (Itemp)*	DC Resistance
Infotainment	Powertrain/Safety					
DEM8045Z-1R5N□	—	1.5μH ±30%	0.1MHz	11200mA	9400mA	0.0065Ω±20%
DEM8045Z-2R2N□	—	2.2μH ±30%	0.1MHz	9300mA	8700mA	0.0083Ω±20%
DEM8045Z-3R3N□	—	3.3μH ±30%	0.1MHz	7700mA	6800mA	0.0120Ω±20%
DEM8045Z-4R7N□	—	4.7μH ±30%	0.1MHz	6700mA	6300mA	0.0150Ω±20%
DEM8045Z-5R6N□	—	5.6μH ±30%	0.1MHz	6100mA	5400mA	0.0190Ω±20%
DEM8045Z-6R8N□	—	6.8μH ±30%	0.1MHz	5200mA	4800mA	0.0230Ω±20%
DEM8045Z-8R2M□	—	8.2μH ±20%	0.1MHz	4800mA	4500mA	0.0280Ω±20%
DEM8045Z-100M□	—	10μH ±20%	0.1MHz	4300mA	3900mA	0.0330Ω±20%
DEM8045Z-150M□	—	15μH ±20%	0.1MHz	3300mA	3500mA	0.0440Ω±20%
DEM8045Z-180M□	—	18μH ±20%	0.1MHz	3200mA	2900mA	0.0640Ω±20%
DEM8045Z-220M□	—	22μH ±20%	0.1MHz	2900mA	2400mA	0.0780Ω±20%
DEM8045Z-330M□	—	33μH ±20%	0.1MHz	2300mA	2200mA	0.1100Ω±20%
DEM8045Z-470M□	—	47μH ±20%	0.1MHz	2100mA	1800mA	0.1700Ω±20%

Operating temp.range (Self-temp.rise included): -40 to 125°C

Only for reflow soldering

\*Isat: Rated Current based on Inductance change

\*Itemp: Rated Current based on Temperature rise

Rated current (Isat) is specified when the decrease of the initial inductance value at 30%.

Rated current (Itemp) is specified when temperature of the inductor is raised 40°C by DC current.

Class of Magnetic Shield: Ferrite Core

### Inductance-Frequency Characteristics (Typ.)

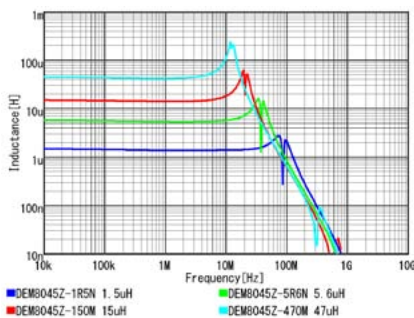

### Inductance-Current Characteristics (Typ.)

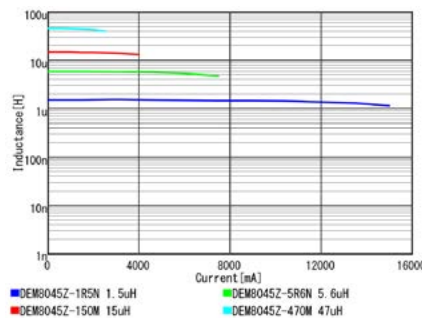

### Temperature Rise Characteristics (Typ.)

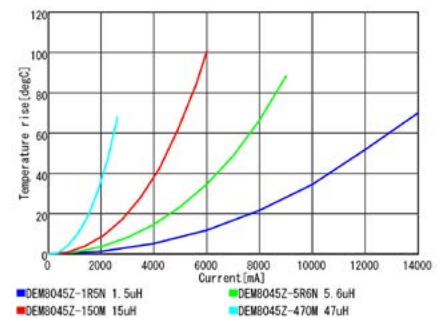

Continued on the following page. ↗



Continued from the preceding page. ↘

### Notice(Rating)

Max. current (DC, AC) as function of product temperature (derating curve).

Derating of Rated Current

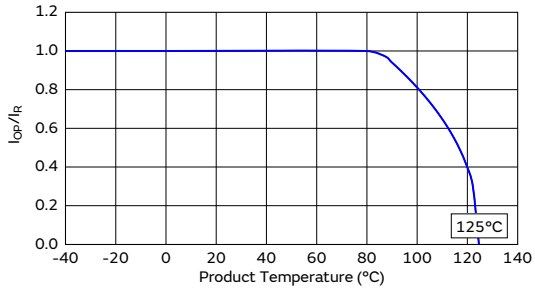

Chip Ferrite Bead

Chip EMIFIL

Chip Common Mode Choke Coil

Block Type EMIFIL

Microchip Transformer (Balun)

Inductors for Power Lines

Inductors for General Circuits

RF Inductors

## Inductors for Power Lines

# LQM18PZ\_CH Series 0603 (1608) inch (mm)

### Specifications Sheet (with cautions/mounting/packaging)

Infotainment	<a href="https://search.murata.co.jp/Ceramy/image/img/P02/JELF243B-9120.pdf">https://search.murata.co.jp/Ceramy/image/img/P02/JELF243B-9120.pdf</a>
Powertrain/Safety	—

### Appearance/Dimensions

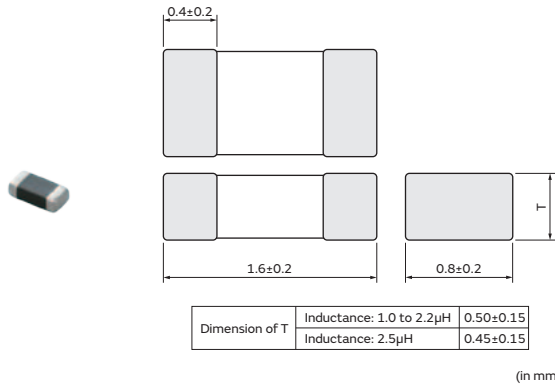

### Packaging

Code	Packaging	Minimum Quantity
D	ø180mm Paper Taping	4000
B	Packing in Bulk	1000

### Rated Value (□: packaging code)

Part Number		Inductance	Inductance Test Frequency	Rated Current (Isat)*	Rated Current (Itemp)*	Max. of DC Resistance	S.R.F* (min.)
Infotainment	Powertrain/Safety						
LQM18PZ1R0MCH□	—	1μH ±20%	1MHz	600mA	950mA(Ambient temp.85°C) 650mA(Ambient temp.125°C)	0.29Ω	80MHz
LQM18PZ2R2MCH□	—	2.2μH ±20%	1MHz	200mA	750mA(Ambient temp.85°C) 500mA(Ambient temp.125°C)	0.48Ω	50MHz
LQM18PZ2R5NCH□	—	2.5μH ±30%	1MHz	100mA	900mA(Ambient temp.85°C) 640mA(Ambient temp.125°C)	0.3Ω	50MHz

Operating temp.range: -55 to 125°C

Class of Magnetic Shield: Ferrite Core

Only for reflow soldering

\*Isat: Rated Current based on Inductance change

\*Itemp: Rated Current based on Temperature rise

\*S.R.F: Self Resonant Frequency

Please consider 'Notice (Rating)'. When rated current is applied to the products, inductance will be within ±30% of initial inductance value range. When rated current is applied to the products, the temperature rise caused by self-generated heat shall be limited to 40°C max.

### Inductance-Frequency Characteristics (Typ.)

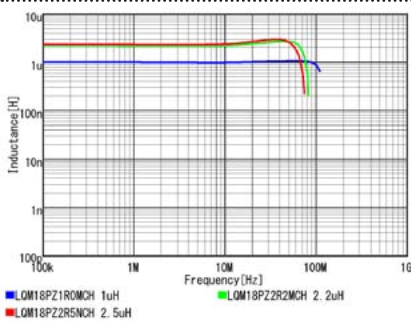

### Inductance-Current Characteristics (Typ.)

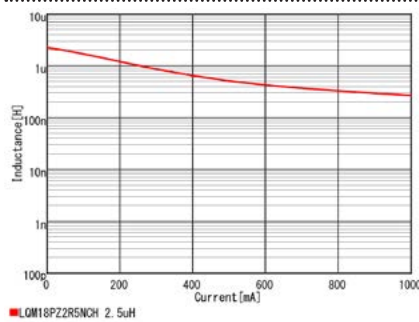

### Temperature Rise Characteristics (Typ.)

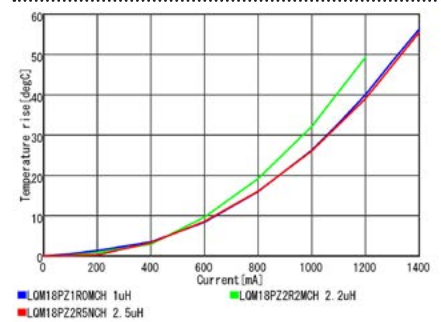

Continued on the following page. ↗

Continued from the preceding page. ↘

### Notice(Rating)

In operating temperatures exceeding +85°C, derating of current is necessary for this series.

Please apply the derating curve shown in the chart according to the operating temperature.

#### Derating of Rated Current

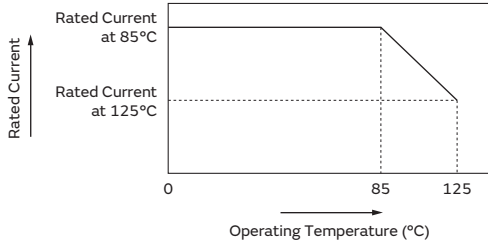

## Inductors for Power Lines

# LQM18PZ\_DH Series 0603 (1608) inch (mm)

### Specifications Sheet (with cautions/mounting/packaging)

Infotainment	<a href="https://search.murata.co.jp/Ceramy/image/img/P02/JELF243B-9121.pdf">https://search.murata.co.jp/Ceramy/image/img/P02/JELF243B-9121.pdf</a>
Powertrain/Safety	—

### Appearance/Dimensions

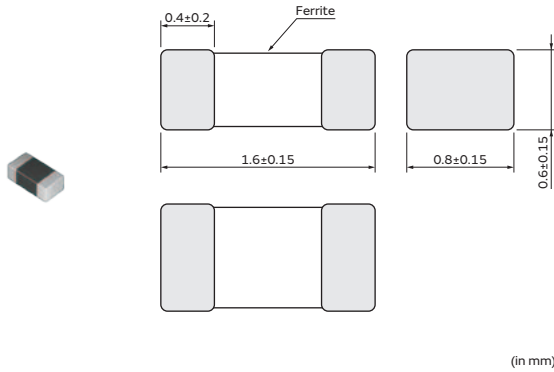

### Packaging

Code	Packaging	Minimum Quantity
D	ø180mm Paper Taping	4000
B	Packing in Bulk	1000

### Rated Value (□: packaging code)

Part Number		Inductance	Inductance Test Frequency	Rated Current (Isat)*	Rated Current (Itemp)*	Max. of DC Resistance	S.R.F.* (min.)
Infotainment	Powertrain/Safety						
LQM18PZ2R2MDH□	—	2.2μH ±20%	1MHz	250mA	650mA(Ambient temp.85°C) 450mA(Ambient temp.125°C)	0.47Ω	80MHz

Operating temp.range: -55 to 125°C  
 Class of Magnetic Shield: Ferrite Core

Only for reflow soldering

\*Isat: Rated Current based on Inductance change

\*Itemp: Rated Current based on Temperature rise

\*S.R.F: Self Resonant Frequency

Please consider 'Notice (Rating).' When rated current is applied to the products, inductance will be within ±30% of initial inductance value range. When rated current is applied to the products, the temperature rise caused by self-generated heat shall be limited to 40°C max.

### Inductance-Frequency Characteristics (Typ.)

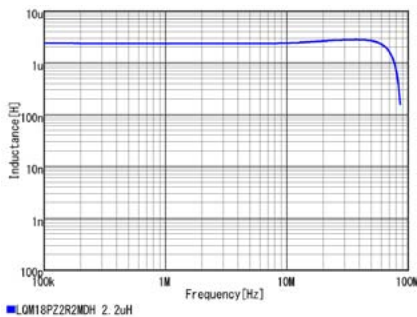

### Inductance-Current Characteristics (Typ.)

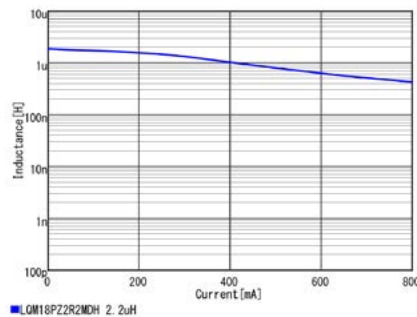

### Temperature Rise Characteristics (Typ.)

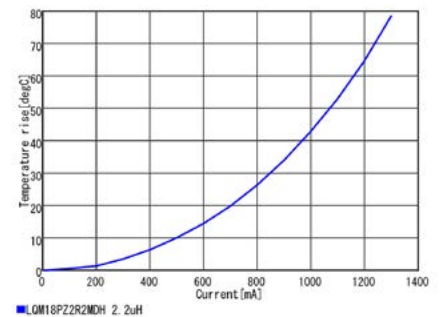

Continued on the following page. ↗

Continued from the preceding page. ↘

### Notice(Rating)

In operating temperatures exceeding +85°C, derating of current is necessary for this series.

Please apply the derating curve shown in the chart according to the operating temperature.

#### Derating of Rated Current

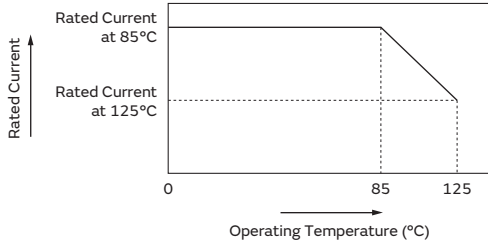

Chip Ferrite Bead

Chip EMIFIL

Chip Common Mode Choke Coil

Block Type EMIFIL

Microchip Transformer (Balun)

Inductors for Power Lines

Inductors for General Circuits

RF Inductors

## Inductors for Power Lines

# LQM18PH\_FR Series 0603 (1608) inch (mm)

### Specifications Sheet (with cautions/mounting/packaging)

Infotainment	—
Powertrain/Safety	<a href="https://search.murata.co.jp/Ceramy/image/img/P02/JELF243B-9126.pdf">https://search.murata.co.jp/Ceramy/image/img/P02/JELF243B-9126.pdf</a>

### Appearance/Dimensions

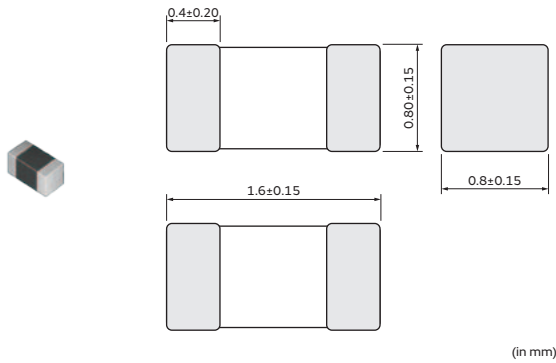

### Packaging

Code	Packaging	Minimum Quantity
L	ø180mm Embossed Taping	4000
B	Packing in Bulk	1000

### Rated Value (□: packaging code)

Part Number		Inductance	Inductance Test Frequency	Rated Current (Isat)*	Rated Current (Itemp)*	DC Resistance	S.R.F* (min.)
Infotainment	Powertrain/Safety						
—	LQM18PHR22MFR□	0.22μH ±20%	1MHz	1500mA	1250mA(Ambient temp.85°C) 850mA(Ambient temp.125°C) 10mA(Ambient temp.150°C)	0.11Ω	100MHz
—	LQM18PHR47MFR□	0.47μH ±20%	1MHz	1200mA	1100mA(Ambient temp.85°C) 730mA(Ambient temp.125°C) 10mA(Ambient temp.150°C)	0.15Ω	100MHz
—	LQM18PH1R0MFR□	1μH ±20%	1MHz	360mA	950mA(Ambient temp.85°C) 630mA(Ambient temp.125°C) 10mA(Ambient temp.150°C)	0.2Ω	100MHz
—	LQM18PH1R5MFR□	1.5μH ±20%	1MHz	240mA	800mA(Ambient temp.85°C) 570mA(Ambient temp.125°C) 10mA(Ambient temp.150°C)	0.23Ω	100MHz
—	LQM18PH2R2MFR□	2.2μH ±20%	1MHz	150mA	750mA(Ambient temp.85°C) 500mA(Ambient temp.125°C) 10mA(Ambient temp.150°C)	0.3Ω	70MHz
—	LQM18PH3R3MFR□	3.3μH ±20%	1MHz	80mA	700mA(Ambient temp.85°C) 470mA(Ambient temp.125°C) 10mA(Ambient temp.150°C)	0.35Ω	60MHz
—	LQM18PH4R7MFR□	4.7μH ±20%	1MHz	70mA	620mA(Ambient temp.85°C) 420mA(Ambient temp.125°C) 10mA(Ambient temp.150°C)	0.44Ω	40MHz

Operating temp.range: -55 to 150°C

Class of Magnetic Shield: Ferrite Core

\*Isat: Rated Current based on Inductance change

\*Itemp: Rated Current based on Temperature rise

\*S.R.F: Self Resonant Frequency

Please consider 'Notice (Rating)'. When applied Rated current to the Products, Inductance will be within ±30% of initial inductance value range. When applied Rated current to the Products, temperature rise caused by self-generated heat shall be limited to 40°C max.

Continued on the following page. ↗

Continued from the preceding page. ↘

**Inductance-Frequency Characteristics (Typ.)**

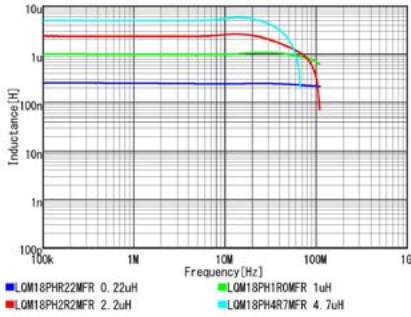

**Inductance-Current Characteristics (Typ.)**

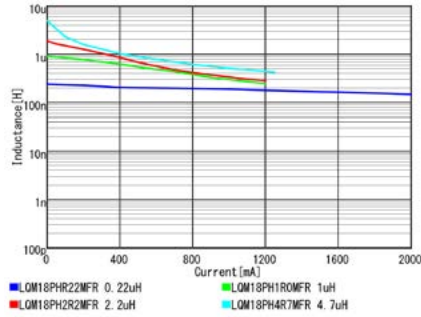

**Temperature Rise Characteristics (Typ.)**

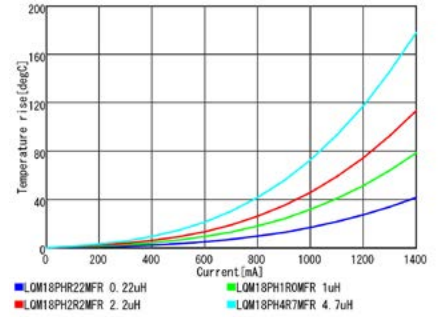

**Notice(Rating)**

In operating temperatures exceeding +85°C, derating of current is necessary for this series. Please apply the derating curve shown in the chart according to the operating temperature.

**Derating of Rated Current**

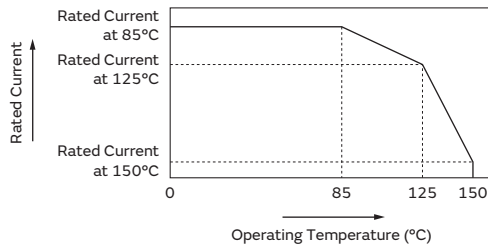

Chip Ferrite Bead

Chip EMI FIL

Chip Common Mode Choke Coil

Block Type EMI FIL

Microchip Transformer (Balun)

Inductors for Power Lines

Inductors for General Circuits

RF Inductors

# Inductors for Power Lines

## LQM18PZ\_FH Series 0603 (1608) inch (mm)

### Specifications Sheet (with cautions/mounting/packaging)

Infotainment	<a href="https://search.murata.co.jp/Ceramy/image/img/P02/JELF243B-9122.pdf">https://search.murata.co.jp/Ceramy/image/img/P02/JELF243B-9122.pdf</a>
Powertrain/Safety	—

### Appearance/Dimensions

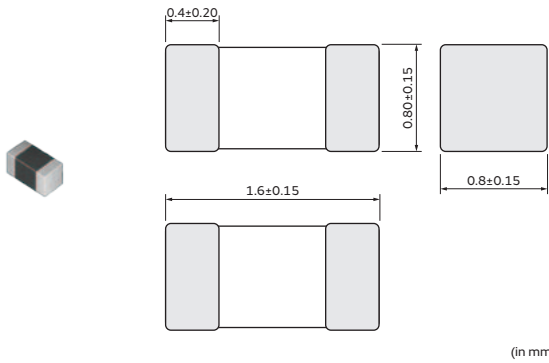

### Packaging

Code	Packaging	Minimum Quantity
D	ø180mm Paper Taping	4000
B	Packing in Bulk	1000

### Rated Value (□: packaging code)

Part Number		Inductance	Inductance Test Frequency	Rated Current (Isat)*	Rated Current (Itemp)*	Max. of DC Resistance	S.R.F.* (min.)
Infotainment	Powertrain/Safety						
LQM18PZ2R2MFH□	—	2.2μH ±20%	1MHz	300mA	700mA(Ambient temp.85°C) 500mA(Ambient temp.125°C)	0.47Ω	80MHz

Operating temp.range: -55 to 125°C  
 Class of Magnetic Shield: Ferrite Core

Only for reflow soldering

\*Isat: Rated Current based on Inductance change

\*Itemp: Rated Current based on Temperature rise

\*S.R.F: Self Resonant Frequency

Please consider 'Notice (Rating).' When rated current is applied to the products, inductance will be within ±30% of initial inductance value range. When rated current is applied to the products, the temperature rise caused by self-generated heat shall be limited to 40°C max.

### Inductance-Frequency Characteristics (Typ.)

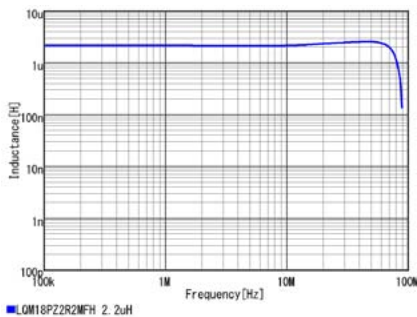

### Inductance-Current Characteristics (Typ.)

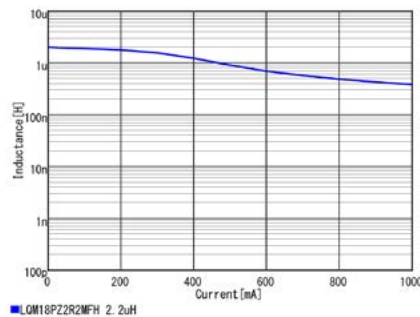

### Temperature Rise Characteristics (Typ.)

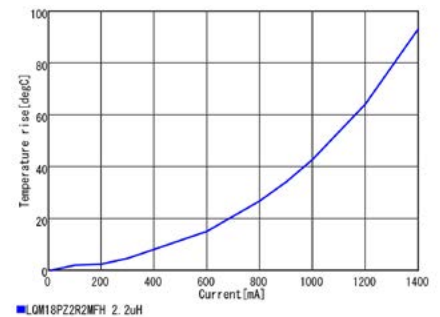

Continued on the following page. ↗



Continued from the preceding page. ↘

### Notice(Rating)

In operating temperatures exceeding +85°C, derating of current is necessary for this series.  
Please apply the derating curve shown in the chart according to the operating temperature.

#### Derating of Rated Current

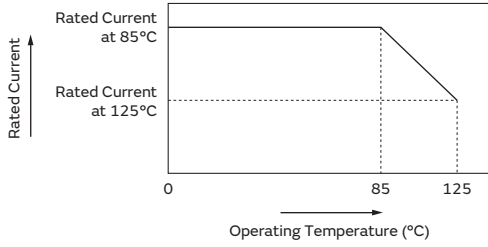

# Inductors for Power Lines

## LQM18DZ\_70/LQM18DH\_70 Series 0603 (1608) inch (mm)

### Specifications Sheet (with cautions/mounting/packaging)

Infotainment	<a href="https://search.murata.co.jp/Ceramy/image/img/P02/JELF243B-9128.pdf">https://search.murata.co.jp/Ceramy/image/img/P02/JELF243B-9128.pdf</a>
Powertrain/Safety	<a href="https://search.murata.co.jp/Ceramy/image/img/P02/JELF243B-9127.pdf">https://search.murata.co.jp/Ceramy/image/img/P02/JELF243B-9127.pdf</a>

### Appearance/Dimensions

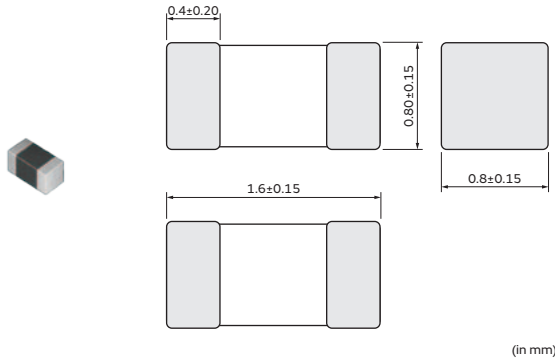

### Packaging

Code	Packaging	Minimum Quantity
L	ø180mm Embossed Taping	4000
B	Packing in Bulk	1000

### Rated Value (□: packaging code)

Part Number		Inductance	Inductance Test Frequency	Rated Current (Isat)*	Rated Current (Itemp)*	DC Resistance	S.R.F* (min.)
Infotainment	Powertrain/Safety						
LQM18DZ6R8M70□	LQM18DH6R8M70□	6.8μH ±20%	1MHz	120mA	330mA/330mA(Ambient temp.125°C) 10mA(Ambient temp.150°C)	0.74Ω±0.22Ω/0.74±0.22Ω	40MHz
LQM18DZ100M70□	LQM18DH100M70□	10μH ±20%	1MHz	100mA	300mA/300mA(Ambient temp.125°C) 10mA(Ambient temp.150°C)	1.05Ω±0.32Ω/1.05±0.32Ω	32MHz
LQM18DZ150M70□	LQM18DH150M70□	15μH ±20%	1MHz	80mA	220mA/220mA(Ambient temp.125°C) 10mA(Ambient temp.150°C)	1.95Ω±0.59Ω	24MHz
LQM18DZ220M70□	LQM18DH220M70□	22μH ±20%	1MHz	50mA	200mA/200mA(Ambient temp.125°C) 10mA(Ambient temp.150°C)	2.4Ω±0.72Ω	15MHz
LQM18DZ330M70□	LQM18DH330M70□	33μH ±20%	1MHz	30mA	200mA/200mA(Ambient temp.125°C) 10mA(Ambient temp.150°C)	2.4Ω±0.72Ω	13MHz
LQM18DZ470M70□	LQM18DH470M70□	47μH ±20%	1MHz	20mA	180mA/180mA(Ambient temp.125°C) 10mA(Ambient temp.150°C)	2.55Ω±0.77Ω	10MHz

Operating temp.range: -55 to 125°C/-55 to 150°C

Class of Magnetic Shield: Ferrite Core

\*Isat: Rated Current based on Inductance change

\*Itemp: Rated Current based on Temperature rise

\*S.R.F: Self Resonant Frequency

### Inductance-Frequency Characteristics (Typ.)

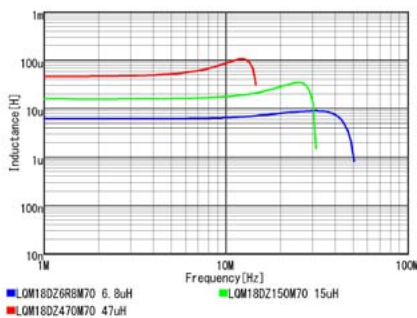

### Inductance-Current Characteristics (Typ.)

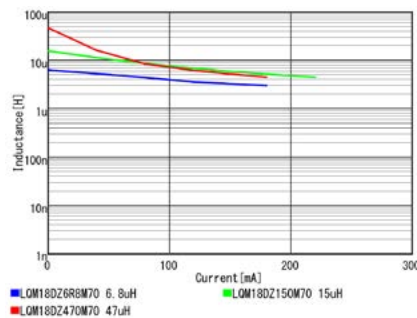

### Temperature Rise Characteristics (Typ.)

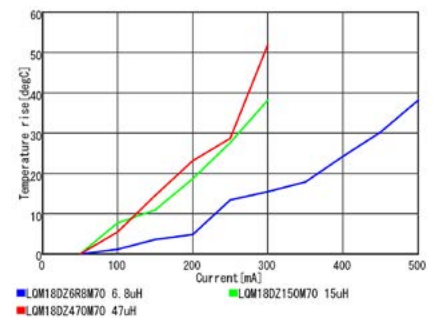

Continued on the following page. ↗

Continued from the preceding page. ↘

### LQM18DH\_70:Notice(Rating)

In operating temperatures exceeding +125°C, derating of current is necessary for this series.

Please apply the derating curve shown in the chart according to the operating temperature.

Derating of Rated Current

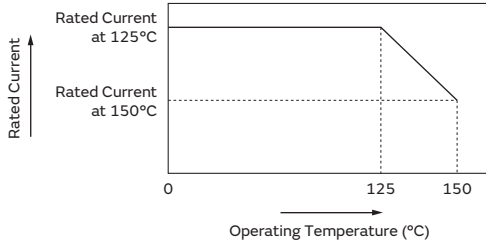

Chip Ferrite Bead

Chip EMIFIL

Chip Common Mode  
Choke Coil

Block Type EMIFIL

Microchip Transformer  
(Balun)

Inductors  
for Power Lines

Inductors for  
General Circuits

RF Inductors

# Inductors for Power Lines

## LQM21PZ\_C0 Series 0805 (2012) inch (mm)

### Specifications Sheet (with cautions/mounting/packaging)

Infotainment	<a href="https://search.murata.co.jp/Ceramy/image/img/P02/JELF243B-9113.pdf">https://search.murata.co.jp/Ceramy/image/img/P02/JELF243B-9113.pdf</a>
Powertrain/Safety	—

### Appearance/Dimensions

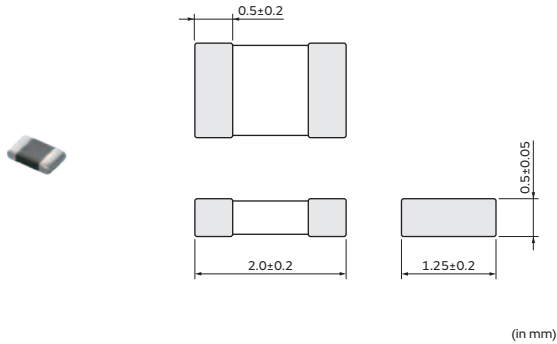

### Packaging

Code	Packaging	Minimum Quantity
D	ø180mm Paper Taping	4000
B	Packing in Bulk	1000

### Rated Value (□: packaging code)

Part Number		Inductance	Inductance Test Frequency	Rated Current	DC Resistance	S.R.F* (min.)
Infotainment	Powertrain/Safety					
LQM21PZR47MC0□	—	0.47μH ±20%	1MHz	1.1A(Ambient temp.85°C) 0.82A(Ambient temp.125°C)	0.12Ω±25%	100MHz
LQM21PZ1R0MC0□	—	1μH ±20%	1MHz	0.8A(Ambient temp.85°C) 0.60A(Ambient temp.125°C)	0.19Ω±25%	90MHz
LQM21PZ1R5MC0□	—	1.5μH ±20%	1MHz	0.7A(Ambient temp.85°C) 0.52A(Ambient temp.125°C)	0.26Ω±25%	70MHz
LQM21PZ2R2MC0□	—	2.2μH ±20%	1MHz	0.6A(Ambient temp.85°C) 0.45A(Ambient temp.125°C)	0.34Ω±25%	50MHz

Operating temp.range: -55 to 125°C

Class of Magnetic Shield: Ferrite Core

\*S.R.F: Self Resonant Frequency

Please consider 'Notice (Rating).' When rated current is applied to the products, the temperature rise caused by self-generated heat shall be limited to 40°C max.

### Inductance-Frequency Characteristics (Typ.)

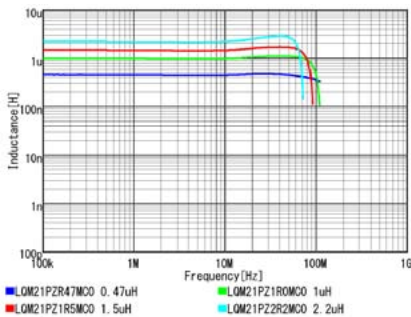

### Inductance-Current Characteristics (Typ.)

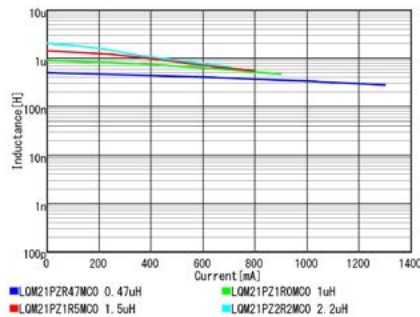

### Temperature Rise Characteristics (Typ.)

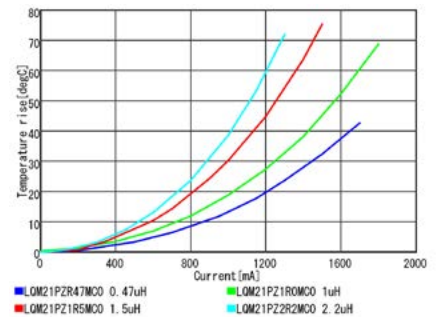

Continued on the following page. ↗

Continued from the preceding page. ↘

### Notice(Rating)

In operating temperatures exceeding +85°C, derating of current is necessary for this series.

Please apply the derating curve shown in the chart according to the operating temperature.

#### Derating of Rated Current

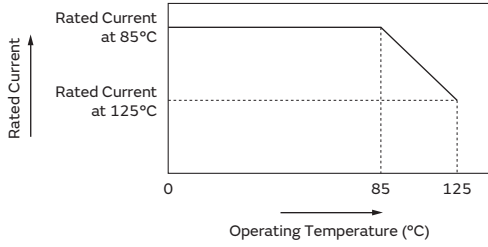

Chip Ferrite Bead

Chip EMIFIL

Chip Common Mode Choke Coil

Block Type EMIFIL

Microchip Transformer (Balun)

Inductors for Power Lines

Inductors for General Circuits

RF Inductors

# Inductors for Power Lines

## LQM21PZ\_G0/LQM21PH\_G0 Series 0805 (2012) inch (mm)

### Specifications Sheet (with cautions/mounting/packaging)

Infotainment	<a href="https://search.murata.co.jp/Ceramy/image/img/P02/JELF243B-9114.pdf">https://search.murata.co.jp/Ceramy/image/img/P02/JELF243B-9114.pdf</a>
Powertrain/Safety	<a href="https://search.murata.co.jp/Ceramy/image/img/P02/JELF243B-9124.pdf">https://search.murata.co.jp/Ceramy/image/img/P02/JELF243B-9124.pdf</a>

### Appearance/Dimensions

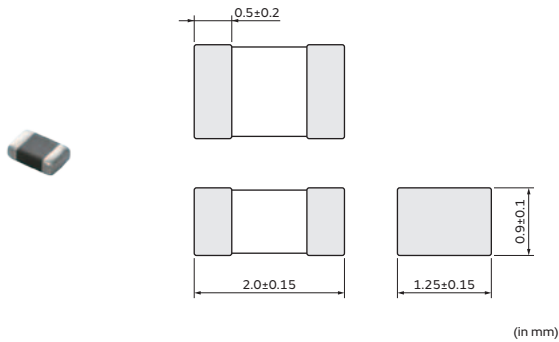

### Packaging

Code	Packaging	Minimum Quantity
D	ø180mm Paper Taping	4000
B	Packing in Bulk	1000

### Rated Value (□: packaging code)

Part Number		Inductance	Inductance Test Frequency	Rated Current (Isat)*	Rated Current (Itemp)*	DC Resistance	S.R.F* (min.)	Operating temp.range	Remark
Infotainment	Powertrain/Safety								
LQM21PZR47MG0□	—	0.47μH ±20%	1MHz	-	1.3A(Ambient temp.85°C) 0.95A(Ambient temp.125°C)	0.075Ω(typ.)	100MHz	-55 to 125°C	*1
—	LQM21PHR47NG0□	0.47μH ±30%	1MHz	2150mA(Max.) / 2700mA(Typ.)	1300mA(Ambient temp.85°C) 950mA(Ambient temp.125°C) 10mA(Ambient temp.150°C)	0.075Ω	100MHz	-55 to 150°C	*2
LQM21PZR54MG0□	—	0.54μH ±20%	1MHz	-	1.3A(Ambient temp.85°C) 0.95A(Ambient temp.125°C)	0.075Ω(typ.)	100MHz	-55 to 125°C	*1
—	LQM21PHR54NG0□	0.54μH ±30%	1MHz	1600mA(Max.) / 2000mA(Typ.)	1300mA(Ambient temp.85°C) 950mA(Ambient temp.125°C) 10mA(Ambient temp.150°C)	0.075Ω	100MHz	-55 to 150°C	*2
LQM21PZ3R3NG0□	—	3.3μH ±30%	1MHz	-	0.8A(Ambient temp.85°C) 0.55A(Ambient temp.125°C)	0.165Ω±25%	30MHz	-55 to 125°C	*1
LQM21PZ3R3MG0□	—	3.3μH ±20%	1MHz	-	0.8A(Ambient temp.85°C) 0.55A(Ambient temp.125°C)	0.165Ω±25%	30MHz	-55 to 125°C	*1

Class of Magnetic Shield: Ferrite Core

\*Isat: Rated Current based on Inductance change

\*Itemp: Rated Current based on Temperature rise

\*S.R.F: Self Resonant Frequency

\*1: Please consider 'Notice (Rating).' When rated current is applied to the products, the temperature rise caused by self-generated heat shall be limited to 40°C max.

\*2: Please consider 'Notice (Rating).' When rated current is applied to the products, inductance will be within ±30% of initial inductance value range When rated current is applied to the products, the temperature rise caused by self-generated heat shall be limited to 40°C max.

### Inductance-Frequency Characteristics (Typ.)

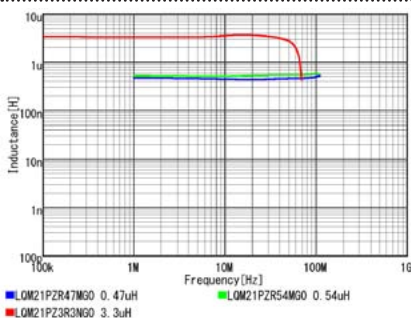

### Inductance-Current Characteristics (Typ.)

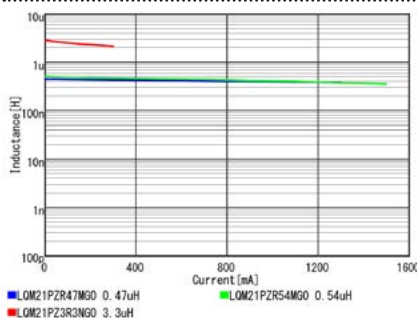

### Temperature Rise Characteristics (Typ.)

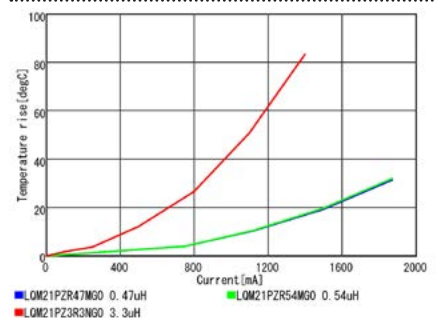

Continued on the following page. ↗

Continued from the preceding page. ↘

### LQM21PZ\_G0:Notice(Rating)

In operating temperatures exceeding +85°C, derating of current is necessary for this series.  
 Please apply the derating curve shown in the chart according to the operating temperature.

Derating of Rated Current

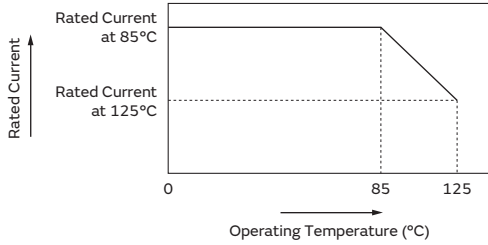

### LQM21PH\_G0:Notice(Rating)

In operating temperatures exceeding +125°C, derating of current is necessary for this series.  
 Please apply the derating curve shown in the chart according to the operating temperature.

Derating of Rated Current

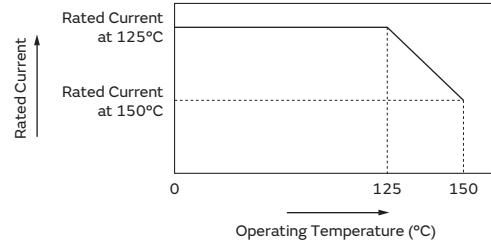

Chip Ferrite Bead

Chip EMIFIL

Chip Common Mode Choke Coil

Block Type EMIFIL

Microchip Transformer (Balun)

Inductors for Power Lines

Inductors for General Circuits

RF Inductors

## Inductors for Power Lines

# LQM21PZ\_GC/LQM21PH\_GC Series 0805 (2012) inch (mm)

### Specifications Sheet (with cautions/mounting/packaging)

Infotainment	<a href="https://search.murata.co.jp/Ceramy/image/img/P02/JELF243B-9114.pdf">https://search.murata.co.jp/Ceramy/image/img/P02/JELF243B-9114.pdf</a>
Powertrain/Safety	<a href="https://search.murata.co.jp/Ceramy/image/img/P02/JELF243B-9124.pdf">https://search.murata.co.jp/Ceramy/image/img/P02/JELF243B-9124.pdf</a>

### Appearance/Dimensions

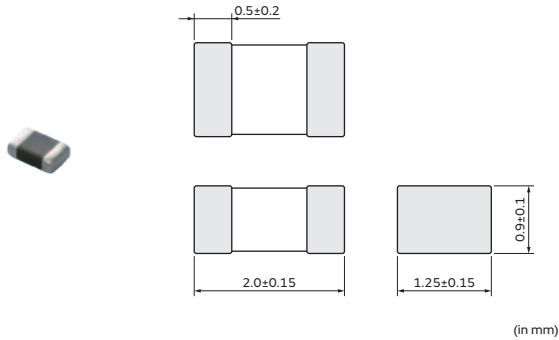

### Packaging

Code	Packaging	Minimum Quantity
D	ø180mm Paper Taping	4000
B	Packing in Bulk	1000

### Rated Value (□: packaging code)

Part Number		Inductance	Inductance Test Frequency	Rated Current (Isat)*	Rated Current (Temp)*	DC Resistance	S.R.F.* (min.)	Operating temp.range	Remark
Infotainment	Powertrain/Safety								
LQM21PZ1R0NGC□	LQM21PH1R0NGC□	1μH ±30%	1MHz	900mA(Max.) / 1150mA(Typ.)	0.9A(Ambient temp.85°C) 0.65A(Ambient temp.125°C)/1000mA(Ambient temp.85°C) 850mA(Ambient temp.125°C) 10mA(Ambient temp.150°C)	0.10Ω±25%/0.1Ω	50MHz	-55 to 125°C/-55 to 150°C	*1
—	LQM21PH1R5NGC□	1.5μH ±30%	1MHz	800mA(Max.) / 1000mA(Typ.)	850mA(Ambient temp.85°C) 650mA(Ambient temp.125°C) 10mA(Ambient temp.150°C)	0.19Ω	45MHz	-55 to 150°C	*2
LQM21PZ2R2NGC□	LQM21PH2R2NGC□	2.2μH ±30%	1MHz	540mA(Max.) / 680mA(Typ.)	0.8A(Ambient temp.85°C) 0.6A(Ambient temp.125°C)/800mA(Ambient temp.85°C) 600mA(Ambient temp.125°C) 10mA(Ambient temp.150°C)	0.23Ω±25%/0.23Ω	40MHz	-55 to 125°C/-55 to 150°C	*1

Class of Magnetic Shield: Ferrite Core

\*Isat: Rated Current based on Inductance change

\*Itemp: Rated Current based on Temperature rise

\*S.R.F.: Self Resonant Frequency

\*1: Please consider 'Notice (Rating).' When rated current is applied to the products, the temperature rise caused by self-generated heat shall be limited to 40°C max./Please consider 'Notice (Rating).' When rated current is applied to the products, inductance will be within ±30% of initial inductance value range When rated current is applied to the products, the temperature rise caused by self-generated heat shall be limited to 40°C max.

\*2: Please consider 'Notice (Rating).' When rated current is applied to the products, inductance will be within ±30% of initial inductance value range When rated current is applied to the products, the temperature rise caused by self-generated heat shall be limited to 40°C max.

### Inductance-Frequency Characteristics (Typ.)

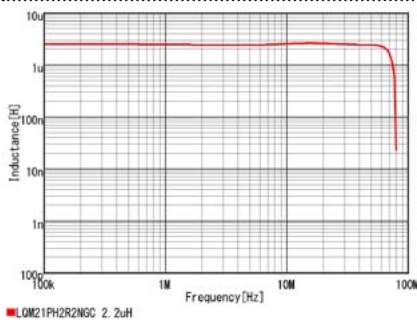

### Inductance-Current Characteristics (Typ.)

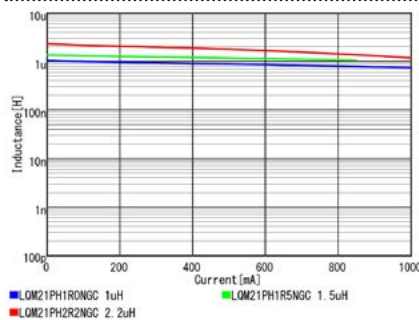

### Temperature Rise Characteristics (Typ.)

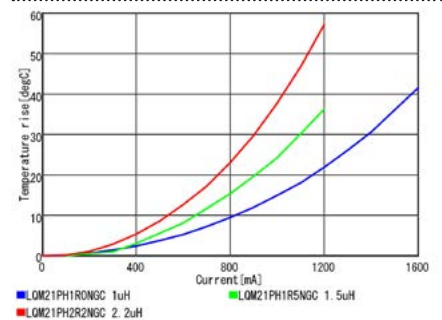

Continued on the following page. ↗



Continued from the preceding page. ↘

### LQM21PZ\_GC:Notice(Rating)

In operating temperatures exceeding +85°C, derating of current is necessary for this series.

Please apply the derating curve shown in the chart according to the operating temperature.

Derating of Rated Current

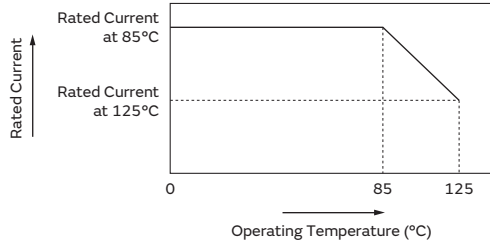

### LQM21PH\_GC:Notice(Rating)

In operating temperatures exceeding +125°C, derating of current is necessary for this series.

Please apply the derating curve shown in the chart according to the operating temperature.

Derating of Rated Current

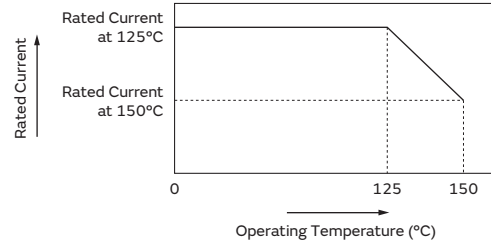

## Inductors for Power Lines

# LQM21PZ\_GR Series 0805 (2012) inch (mm)

### Specifications Sheet (with cautions/mounting/packaging)

Infotainment	<a href="https://search.murata.co.jp/Ceramy/image/img/P02/JELF243B-9114.pdf">https://search.murata.co.jp/Ceramy/image/img/P02/JELF243B-9114.pdf</a>
Powertrain/Safety	—

### Appearance/Dimensions

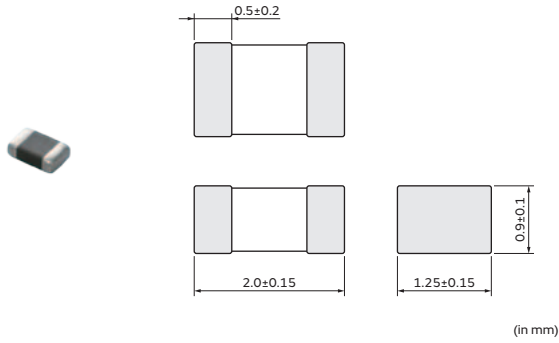

### Packaging

Code	Packaging	Minimum Quantity
D	ø180mm Paper Taping	4000
B	Packing in Bulk	1000

### Rated Value (□: packaging code)

Part Number		Inductance	Inductance Test Frequency	Rated Current	DC Resistance	S.R.F* (min.)
Infotainment	Powertrain/Safety					
LQM21PZ1R0NGR□	—	1μH ±30%	1MHz	1.3A(Ambient temp.85°C) 0.95A(Ambient temp.125°C)	0.066Ω±25%	50MHz
LQM21PZ3R3MGR□	—	3.3μH ±20%	1MHz	1.0A(Ambient temp.85°C) 0.75A(Ambient temp.125°C)	0.15Ω±25%	30MHz
LQM21PZ3R3NGR□	—	3.3μH ±30%	1MHz	1.0A(Ambient temp.85°C) 0.75A(Ambient temp.125°C)	0.15Ω±25%	30MHz
LQM21PZ4R7MGR□	—	4.7μH ±20%	1MHz	0.8A(Ambient temp.85°C) 0.6A(Ambient temp.125°C)	0.23Ω±25%	30MHz
LQM21PZ4R7NGR□	—	4.7μH ±30%	1MHz	0.8A(Ambient temp.85°C) 0.6A(Ambient temp.125°C)	0.23Ω±25%	30MHz

Operating temp.range: -55 to 125°C  
 Class of Magnetic Shield: Ferrite Core

\*S.R.F: Self Resonant Frequency

Please consider 'Notice (Rating)'. When rated current is applied to the products, the temperature rise caused by self-generated heat shall be limited to 40°C max.

### Inductance-Frequency Characteristics (Typ.)

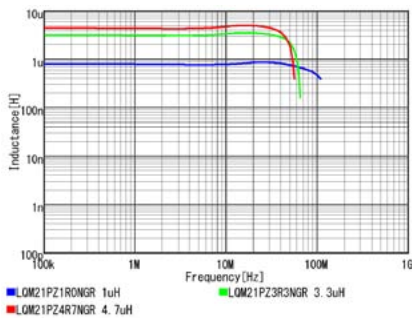

### Inductance-Current Characteristics (Typ.)

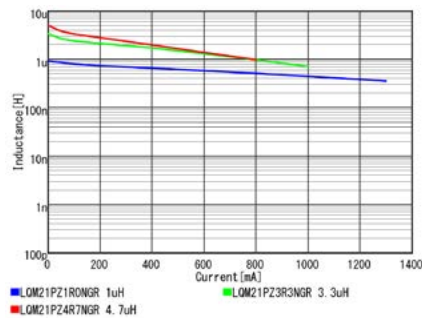

### Temperature Rise Characteristics (Typ.)

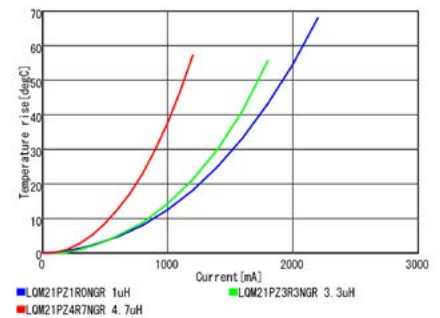

Continued on the following page. ↗

Continued from the preceding page. ↘

### Notice(Rating)

In operating temperatures exceeding +85°C, derating of current is necessary for this series.

Please apply the derating curve shown in the chart according to the operating temperature.

#### Derating of Rated Current

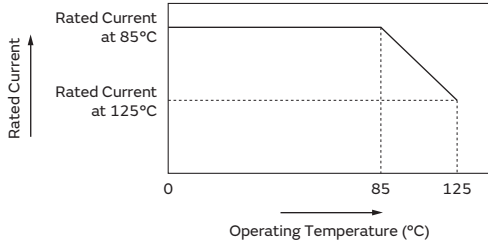

## Inductors for Power Lines

# LQM21DH\_70 Series 0805 (2012) inch (mm)

### Specifications Sheet (with cautions/mounting/packaging)

Infotainment	—
Powertrain/Safety	<a href="https://search.murata.co.jp/Ceramy/image/img/P02/JELF243B-9125.pdf">https://search.murata.co.jp/Ceramy/image/img/P02/JELF243B-9125.pdf</a>

### Appearance/Dimensions

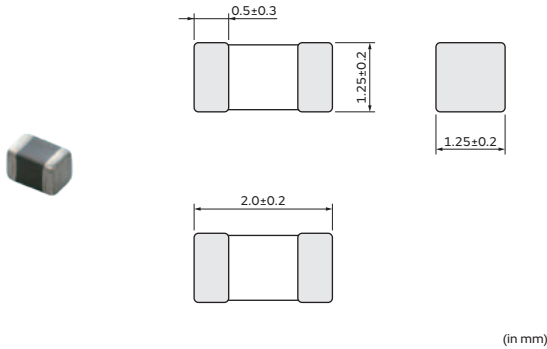

### Packaging

Code	Packaging	Minimum Quantity
L	ø180mm Embossed Taping	3000
B	Packing in Bulk	1000

### Rated Value (□: packaging code)

Part Number		Inductance	Inductance Test Frequency	Rated Current (Isat)*	Rated Current (Itemp)*	Max. of DC Resistance	S.R.F.* (min.)
Infotainment	Powertrain/Safety						
—	LQM21DH100M70□	10μH ±20%	1MHz	250mA	300mA(Ambient temp.125°C) 10mA(Ambient temp.150°C)	0.845Ω	27MHz
—	LQM21DH101M70□	100μH ±20%	1MHz	20mA	160mA(Ambient temp.125°C) 10mA(Ambient temp.150°C)	4.095Ω	8MHz
—	LQM21DH150M70□	15μH ±20%	1MHz	140mA	250mA(Ambient temp.125°C) 10mA(Ambient temp.150°C)	1.235Ω	24MHz
—	LQM21DH220M70□	22μH ±20%	1MHz	100mA	220mA(Ambient temp.125°C) 10mA(Ambient temp.150°C)	1.625Ω	19MHz
—	LQM21DH330M70□	33μH ±20%	1MHz	80mA	200mA(Ambient temp.125°C) 10mA(Ambient temp.150°C)	2.99Ω	16MHz
—	LQM21DH470M70□	47μH ±20%	1MHz	50mA	200mA(Ambient temp.125°C) 10mA(Ambient temp.150°C)	2.99Ω	12MHz

Operating temp.range: -55 to 150°C

Class of Magnetic Shield: Ferrite Core

\*Isat: Rated Current based on Inductance change

\*Itemp: Rated Current based on Temperature rise

\*S.R.F.: Self Resonant Frequency

Please consider 'Notice (Rating)'. When rated current is applied to the products, inductance will be within ±30% of initial inductance value range When rated current is applied to the products, the temperature rise caused by self-generated heat shall be limited to 40°C max.

### Inductance-Frequency Characteristics (Typ.)



### Inductance-Current Characteristics (Typ.)

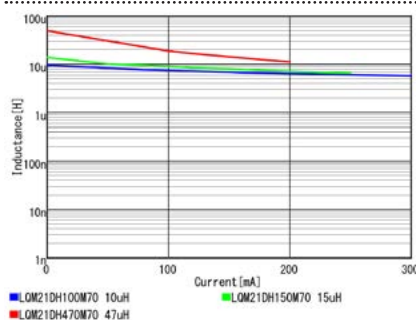

### Temperature Rise Characteristics (Typ.)

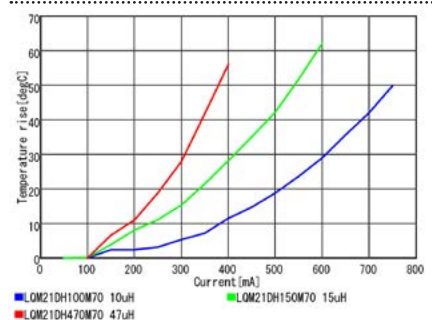

Continued on the following page. ↗

Continued from the preceding page. ↘

### Notice(Rating)

In operating temperatures exceeding +125°C, derating of current is necessary for this series.

Please apply the derating curve shown in the chart according to the operating temperature.

#### Derating of Rated Current

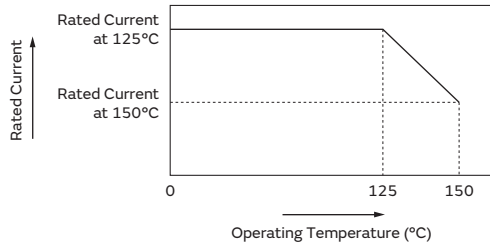

Chip Ferrite Bead

Chip EMIFIL

Chip Common Mode Choke Coil

Block Type EMIFIL

Microchip Transformer (Balun)

Inductors for Power Lines

Inductors for General Circuits

RF Inductors

## Inductors for Power Lines

# LQM2MPZ\_G0 Series 0806 (2016) inch (mm)

### Specifications Sheet (with cautions/mounting/packaging)

Infotainment	<a href="https://search.murata.co.jp/Ceramy/image/img/P02/JELF243B-9109.pdf">https://search.murata.co.jp/Ceramy/image/img/P02/JELF243B-9109.pdf</a>
Powertrain/Safety	—

### Appearance/Dimensions

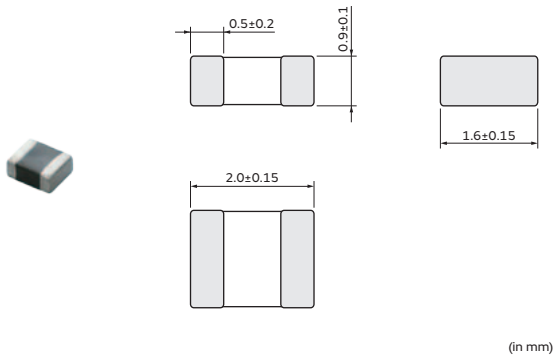

### Packaging

Code	Packaging	Minimum Quantity
L	ø180mm Embossed Taping	3000
B	Packing in Bulk	1000

### Rated Value (□: packaging code)

Part Number		Inductance	Inductance Test Frequency	Rated Current	DC Resistance	S.R.F* (min.)
Infotainment	Powertrain/Safety					
LQM2MPZR47MG0□	—	0.47μH ±20%	1MHz	1.6A(Ambient temp.85°C) 1.2A(Ambient temp.125°C)	0.060Ω(typ.)	100MHz
LQM2MPZR47NG0□	—	0.47μH ±30%	1MHz	1.6A(Ambient temp.85°C) 1.2A(Ambient temp.125°C)	0.060Ω(typ.)	100MHz
LQM2MPZ1R0NG0□	—	1μH ±30%	1MHz	1.4A(Ambient temp.85°C) 1.0A(Ambient temp.125°C)	0.085Ω(typ.)	60MHz
LQM2MPZ1R5MG0□	—	1.5μH ±20%	1MHz	1.2A(Ambient temp.85°C) 0.9A(Ambient temp.125°C)	0.11Ω(typ.)	50MHz
LQM2MPZ1R5NG0□	—	1.5μH ±30%	1MHz	1.2A(Ambient temp.85°C) 0.9A(Ambient temp.125°C)	0.11Ω(typ.)	50MHz
LQM2MPZ2R2MG0□	—	2.2μH ±20%	1MHz	1.2A(Ambient temp.85°C) 0.9A(Ambient temp.125°C)	0.11Ω(typ.)	40MHz
LQM2MPZ2R2NG0□	—	2.2μH ±30%	1MHz	1.2A(Ambient temp.85°C) 0.9A(Ambient temp.125°C)	0.11Ω(typ.)	40MHz
LQM2MPZ3R3NG0□	—	3.3μH ±30%	1MHz	1.2A(Ambient temp.85°C) 0.9A(Ambient temp.125°C)	0.12Ω(typ.)	30MHz
LQM2MPZ4R7MG0□	—	4.7μH ±20%	1MHz	1.1A(Ambient temp.85°C) 0.8A(Ambient temp.125°C)	0.14Ω(typ.)	20MHz
LQM2MPZ4R7NG0□	—	4.7μH ±30%	1MHz	1.1A(Ambient temp.85°C) 0.8A(Ambient temp.125°C)	0.14Ω(typ.)	20MHz

Operating temp.range: -55 to 125°C

Class of Magnetic Shield: Ferrite Core

\*S.R.F: Self Resonant Frequency

Please consider 'Notice (Rating).' When rated current is applied to the products, the temperature rise caused by self-generated heat shall be limited to 40°C max.

Continued on the following page. ↗

Continued from the preceding page. ↘

**Inductance-Frequency Characteristics (Typ.)**

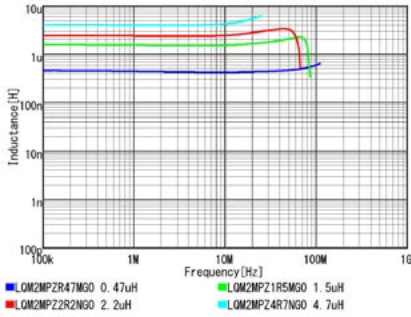

**Inductance-Current Characteristics (Typ.)**

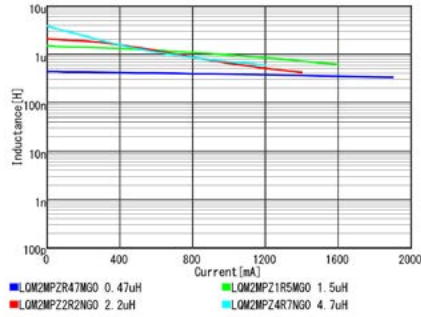

**Temperature Rise Characteristics (Typ.)**

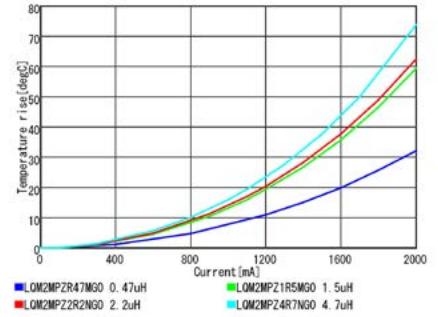

**Notice(Rating)**

In operating temperatures exceeding +85°C, derating of current is necessary for this series. Please apply the derating curve shown in the chart according to the operating temperature.

**Derating of Rated Current**

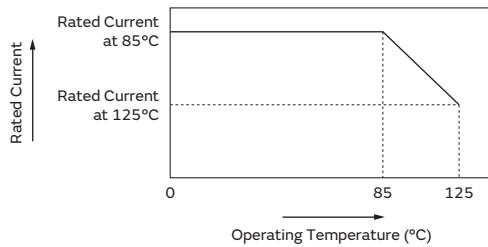

Chip Ferrite Bead

Chip EMIFIL

Chip Common Mode Choke Coil

Block Type EMIFIL

Microchip Transformer (Balun)

Inductors for Power Lines

Inductors for General Circuits

RF Inductors

## Inductors for Power Lines

# LQM2MPZ\_JH Series 0806 (2016) inch (mm)

### Specifications Sheet (with cautions/mounting/packaging)

Infotainment	<a href="https://search.murata.co.jp/Ceramy/image/img/P02/JELF243B-9123.pdf">https://search.murata.co.jp/Ceramy/image/img/P02/JELF243B-9123.pdf</a>
Powertrain/Safety	—

### Appearance/Dimensions

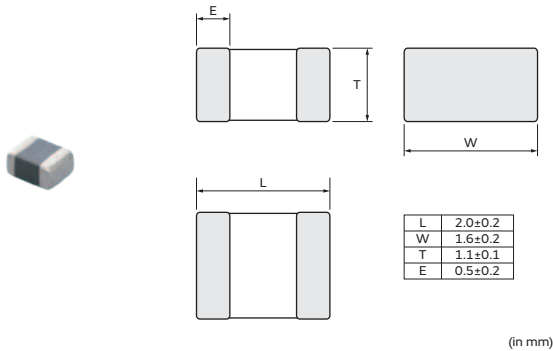

### Packaging

Code	Packaging	Minimum Quantity
L	ø180mm Embossed Taping	3000
B	Packing in Bulk	1000

### Rated Value (□: packaging code)

Part Number		Inductance	Inductance Test Frequency	Rated Current (Isat)*	Rated Current (Itemp)*	Max. of DC Resistance	S.R.F* (min.)
Infotainment	Powertrain/Safety						
LQM2MPZR10MJH□	—	0.1μH ±20%	1MHz	4000mA	4000mA(Ambient temp.85°C) 3000mA(Ambient temp.125°C)	0.019Ω	200MHz

Operating temp.range: -55 to 125°C  
 Class of Magnetic Shield: Ferrite Core

\*Isat: Rated Current based on Inductance change  
 \*Itemp: Rated Current based on Temperature rise  
 \*S.R.F: Self Resonant Frequency

Please consider 'Notice (Rating)'. When rated current is applied to the products, inductance will be within ±30% of initial inductance value range. When rated current is applied to the products, the temperature rise caused by self-generated heat shall be limited to 40°C max.

### Inductance-Frequency Characteristics (Typ.)

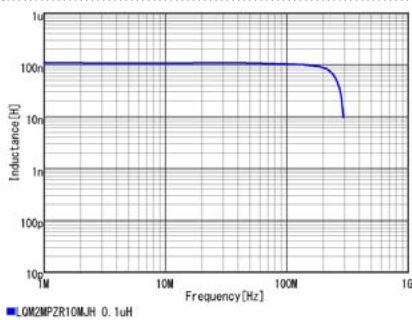

### Inductance-Current Characteristics (Typ.)

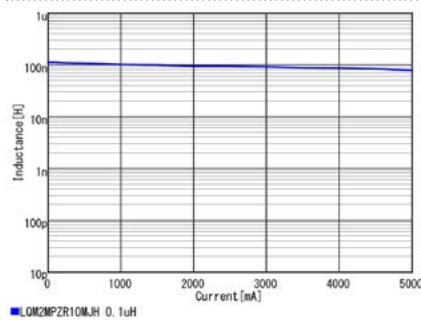

### Temperature Rise Characteristics (Typ.)

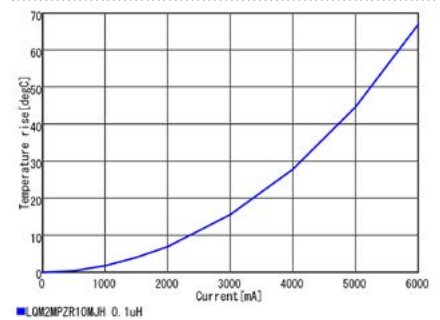

Continued on the following page. ↗



Continued from the preceding page. ↘

### Notice(Rating)

In operating temperatures exceeding +85°C, derating of current is necessary for this series.  
Please apply the derating curve shown in the chart according to the operating temperature.

#### Derating of Rated Current

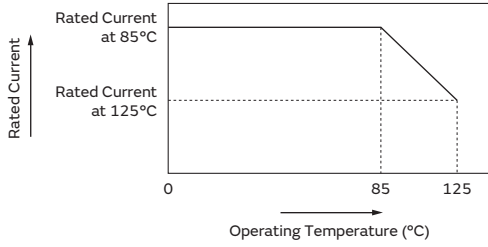

Chip Ferrite Bead

Chip EMIFIL

Chip Common Mode Choke Coil

Block Type EMIFIL

Microchip Transformer (Balun)

Inductors for Power Lines

Inductors for General Circuits

RF Inductors

## Inductors for Power Lines

# LQM2HPZ\_E0 Series 1008 (2520) inch (mm)

### Specifications Sheet (with cautions/mounting/packaging)

Infotainment	<a href="https://search.murata.co.jp/Ceramy/image/img/P02/JELF243B-9115.pdf">https://search.murata.co.jp/Ceramy/image/img/P02/JELF243B-9115.pdf</a>
Powertrain/Safety	—

### Appearance/Dimensions

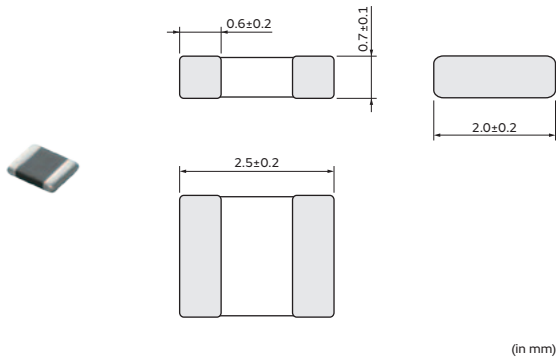

### Packaging

Code	Packaging	Minimum Quantity
L	ø180mm Embossed Taping	3000
B	Packing in Bulk	1000

### Rated Value (□: packaging code)

Part Number		Inductance	Inductance Test Frequency	Rated Current	DC Resistance	S.R.F* (min.)
Infotainment	Powertrain/Safety					
LQM2HPZR56ME0□	—	0.56μH ±20%	1MHz	1.5A(Ambient temp.85°C) 1.1A(Ambient temp.125°C)	0.06Ω±25%	70MHz

Operating temp.range: -55 to 125°C  
 Class of Magnetic Shield: Ferrite Core

\*S.R.F: Self Resonant Frequency

Please consider 'Notice (Rating)!' When rated current is applied to the products, temperature rise caused by self-generated heat shall be limited to 40°C max.

### Inductance-Frequency Characteristics (Typ.)

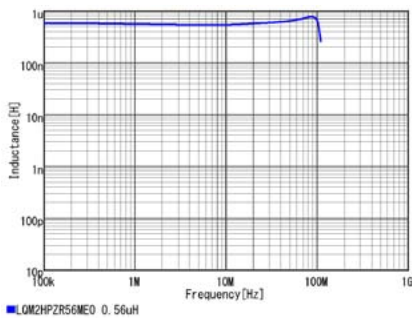

### Inductance-Current Characteristics (Typ.)

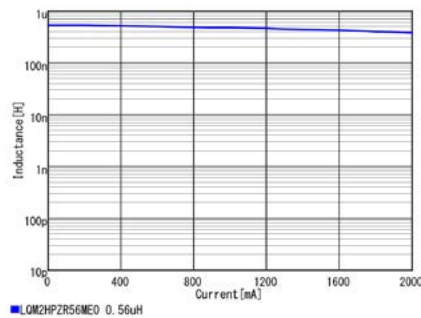

### Temperature Rise Characteristics (Typ.)

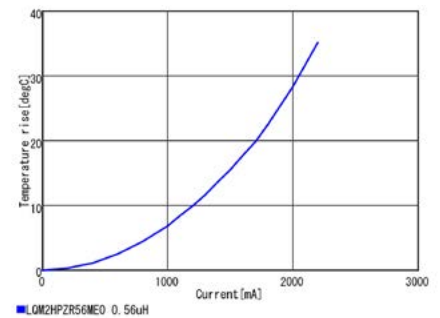

Continued on the following page. ↗

Continued from the preceding page. ↘

### Notice(Rating)

In operating temperatures exceeding +85°C, derating of current is necessary for this series.

Please apply the derating curve shown in the chart according to the operating temperature.

#### Derating of Rated Current

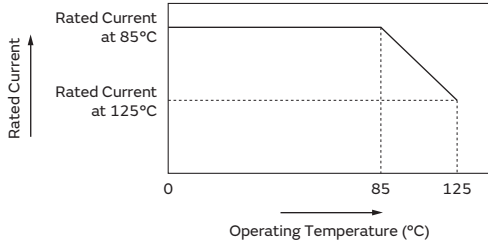

## Inductors for Power Lines

# LQM2HPZ\_G0 Series 1008 (2520) inch (mm)

### Specifications Sheet (with cautions/mounting/packaging)

Infotainment	<a href="https://search.murata.co.jp/Ceramy/image/img/P02/JELF243B-9112.pdf">https://search.murata.co.jp/Ceramy/image/img/P02/JELF243B-9112.pdf</a>
Powertrain/Safety	—

### Appearance/Dimensions

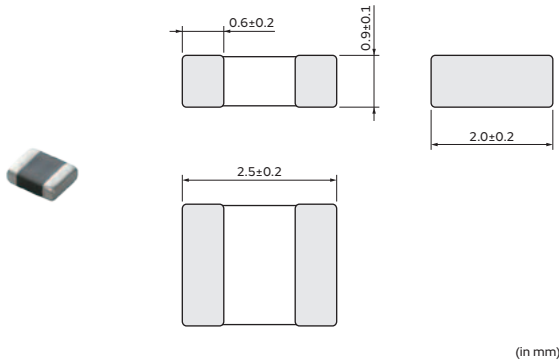

### Packaging

Code	Packaging	Minimum Quantity
L	ø180mm Embossed Taping	3000
B	Packing in Bulk	1000

### Rated Value (□: packaging code)

Part Number		Inductance	Inductance Test Frequency	Rated Current	DC Resistance	S.R.F* (min.)
Infotainment	Powertrain/Safety					
LQM2HPZR47MG0□	—	0.47μH ±20%	1MHz	1.8A(Ambient temp.85°C) 1.3A(Ambient temp.125°C)	0.040Ω±25%	100MHz
LQM2HPZ1R0MG0□	—	1μH ±20%	1MHz	1.6A(Ambient temp.85°C) 1.2A(Ambient temp.125°C)	0.055Ω±25%	60MHz
LQM2HPZ1R5MG0□	—	1.5μH ±20%	1MHz	1.5A(Ambient temp.85°C) 1.1A(Ambient temp.125°C)	0.070Ω±25%	50MHz
LQM2HPZ2R2MG0□	—	2.2μH ±20%	1MHz	1.3A(Ambient temp.85°C) 0.97A(Ambient temp.125°C)	0.080Ω±25%	40MHz
LQM2HPZ3R3MG0□	—	3.3μH ±20%	1MHz	1.2A(Ambient temp.85°C) 0.9A(Ambient temp.125°C)	0.10Ω±25%	30MHz
LQM2HPZ4R7MG0□	—	4.7μH ±20%	1MHz	1.1A(Ambient temp.85°C) 0.82A(Ambient temp.125°C)	0.11Ω±25%	25MHz

Operating temp.range: -55 to 125°C

Class of Magnetic Shield: Ferrite Core

\*S.R.F: Self Resonant Frequency

Please consider 'Notice (Rating)'. When rated current is applied to the products, temperature rise caused by self-generated heat shall be limited to 40°C max.

### Inductance-Frequency Characteristics (Typ.)

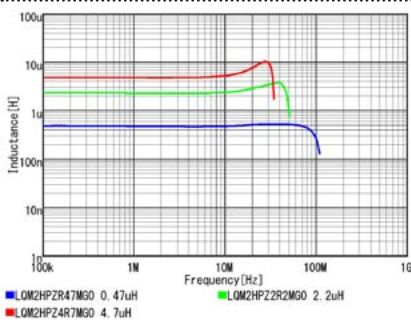

### Inductance-Current Characteristics (Typ.)

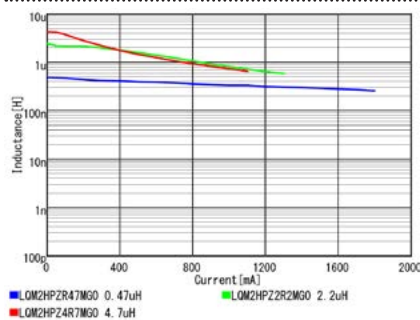

### Temperature Rise Characteristics (Typ.)

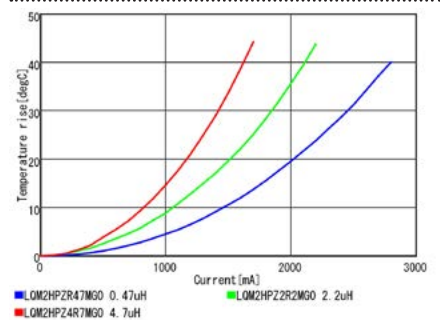

Continued on the following page. ↗

Continued from the preceding page. ↘

### Notice(Rating)

In operating temperatures exceeding +85°C, derating of current is necessary for this series.  
Please apply the derating curve shown in the chart according to the operating temperature.

#### Derating of Rated Current

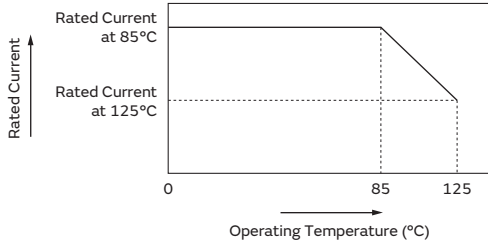

Chip Ferrite Bead

Chip EMIFIL

Chip Common Mode Choke Coil

Block Type EMIFIL

Microchip Transformer (Balun)

Inductors for Power Lines

Inductors for General Circuits

RF Inductors

## Inductors for Power Lines

# LQM2HPZ\_GC Series 1008 (2520) inch (mm)

### Specifications Sheet (with cautions/mounting/packaging)

Infotainment	<a href="https://search.murata.co.jp/Ceramy/image/img/P02/JELF243B-9112.pdf">https://search.murata.co.jp/Ceramy/image/img/P02/JELF243B-9112.pdf</a>
Powertrain/Safety	—

### Appearance/Dimensions

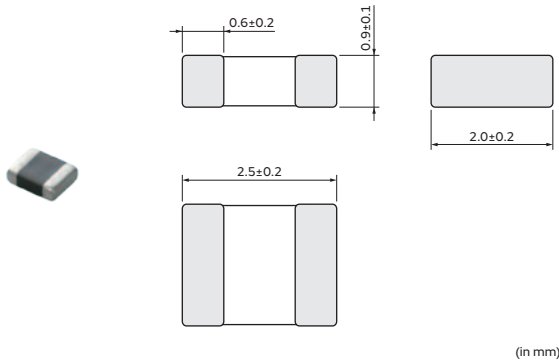

### Packaging

Code	Packaging	Minimum Quantity
L	ø180mm Embossed Taping	3000
B	Packing in Bulk	1000

### Rated Value (□: packaging code)

Part Number		Inductance	Inductance Test Frequency	Rated Current	DC Resistance	S.R.F* (min.)
Infotainment	Powertrain/Safety					
LQM2HPZ1R0MGC□	—	1μH ±20%	1MHz	1.5A(Ambient temp.85°C) 1.1A(Ambient temp.125°C)	0.08Ω±25%	50MHz
LQM2HPZ3R3MGC□	—	3.3μH ±20%	1MHz	1A(Ambient temp.85°C) 0.75A(Ambient temp.125°C)	0.16Ω±25%	30MHz
LQM2HPZ4R7MGC□	—	4.7μH ±20%	1MHz	0.8A(Ambient temp.85°C) 0.6A(Ambient temp.125°C)	0.18Ω±25%	25MHz

Operating temp.range: -55 to 125°C

Class of Magnetic Shield: Ferrite Core

\*S.R.F: Self Resonant Frequency

Please consider 'Notice (Rating).' When rated current is applied to the products, temperature rise caused by self-generated heat shall be limited to 40°C max.

### Inductance-Frequency Characteristics (Typ.)

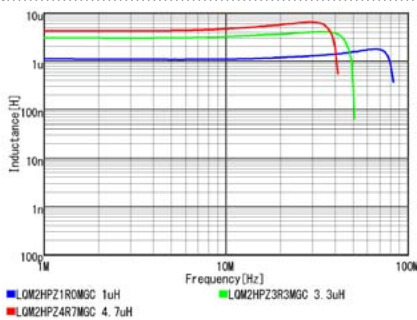

### Inductance-Current Characteristics (Typ.)

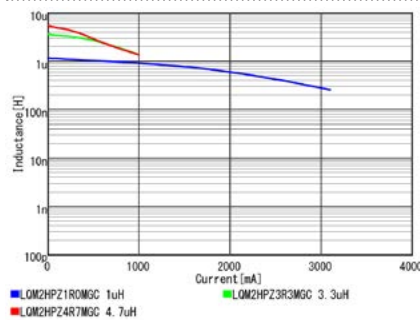

### Temperature Rise Characteristics (Typ.)

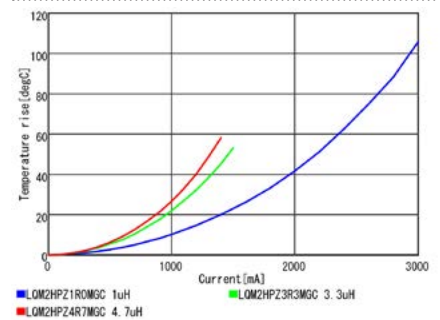

Continued on the following page. ↗

Continued from the preceding page. ↘

### Notice(Rating)

In operating temperatures exceeding +85°C, derating of current is necessary for this series.

Please apply the derating curve shown in the chart according to the operating temperature.

#### Derating of Rated Current

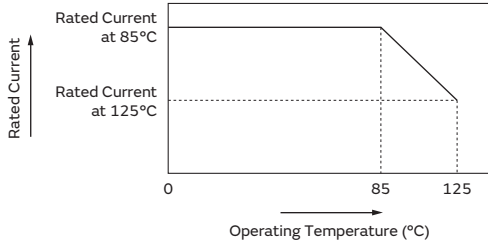

Chip Ferrite Bead

Chip EMIFIL

Chip Common Mode Choke Coil

Block Type EMIFIL

Microchip Transformer (Balun)

Inductors for Power Lines

Inductors for General Circuits

RF Inductors

## Inductors for Power Lines

# LQM2HPZ\_GS Series 1008 (2520) inch (mm)

### Specifications Sheet (with cautions/mounting/packaging)

Infotainment	<a href="https://search.murata.co.jp/Ceramy/image/img/P02/JELF243B-9112.pdf">https://search.murata.co.jp/Ceramy/image/img/P02/JELF243B-9112.pdf</a>
Powertrain/Safety	—

### Appearance/Dimensions

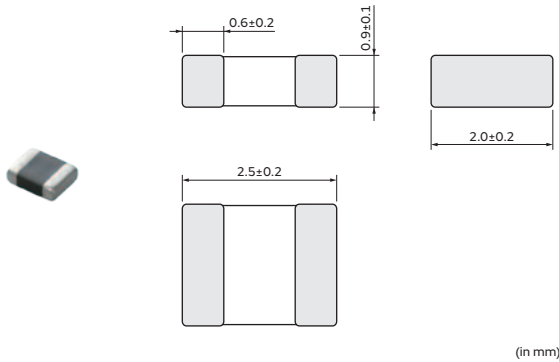

### Packaging

Code	Packaging	Minimum Quantity
L	ø180mm Embossed Taping	3000
B	Packing in Bulk	1000

### Rated Value (□: packaging code)

Part Number		Inductance	Inductance Test Frequency	Rated Current	DC Resistance	S.R.F* (min.)
Infotainment	Powertrain/Safety					
LQM2HPZ2R2MGS□	—	2.2μH ±20%	1MHz	1.1A(Ambient temp.85°C) 0.82A(Ambient temp.125°C)	0.18Ω±25%	40MHz
LQM2HPZ3R3MGS□	—	3.3μH ±20%	1MHz	1.05A(Ambient temp.85°C) 0.78A(Ambient temp.125°C)	0.21Ω±25%	20MHz
LQM2HPZ4R7MGS□	—	4.7μH ±20%	1MHz	1A(Ambient temp.85°C) 0.75A(Ambient temp.125°C)	0.25Ω±25%	20MHz

Operating temp.range: -55 to 125°C

Class of Magnetic Shield: Ferrite Core

\*S.R.F: Self Resonant Frequency

Please consider 'Notice (Rating).' When rated current is applied to the products, temperature rise caused by self-generated heat shall be limited to 40°C max.

### Inductance-Frequency Characteristics (Typ.)

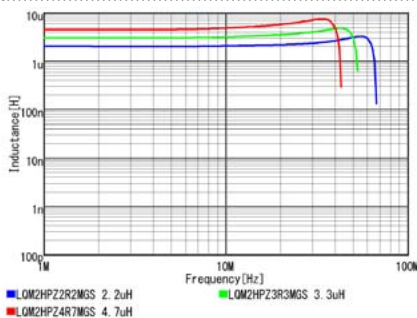

### Inductance-Current Characteristics (Typ.)

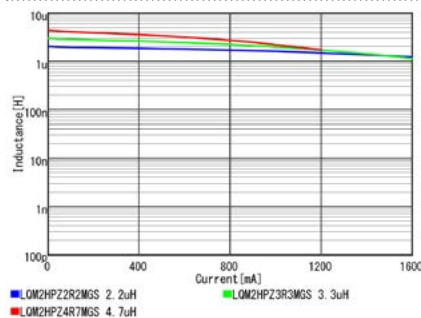

### Temperature Rise Characteristics (Typ.)

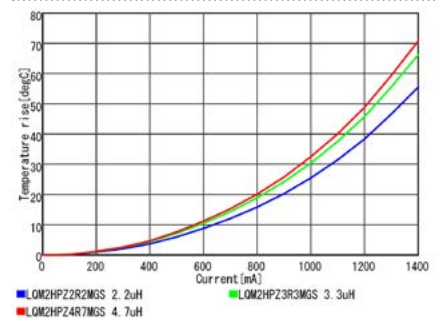

Continued on the following page. ↗



Continued from the preceding page. ↘

### Notice(Rating)

In operating temperatures exceeding +85°C, derating of current is necessary for this series.

Please apply the derating curve shown in the chart according to the operating temperature.

#### Derating of Rated Current

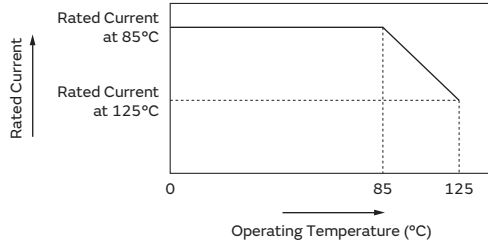

## Inductors for Power Lines

# LQM2HPZ\_J0 Series 1008 (2520) inch (mm)

### Specifications Sheet (with cautions/mounting/packaging)

Infotainment	<a href="https://search.murata.co.jp/Ceramy/image/img/P02/JELF243B-9116.pdf">https://search.murata.co.jp/Ceramy/image/img/P02/JELF243B-9116.pdf</a>
Powertrain/Safety	—

### Appearance/Dimensions

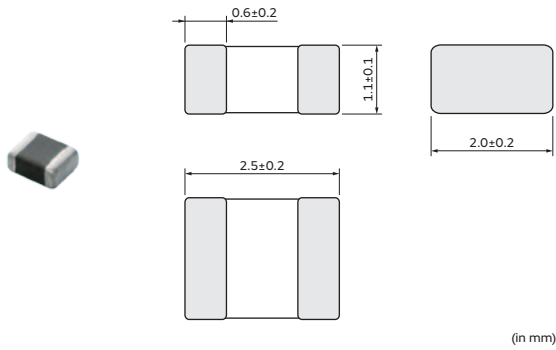

### Packaging

Code	Packaging	Minimum Quantity
L	ø180mm Embossed Taping	3000
B	Packing in Bulk	1000

### Rated Value (□: packaging code)

Part Number		Inductance	Inductance Test Frequency	Rated Current	DC Resistance	S.R.F* (min.)
Infotainment	Powertrain/Safety					
LQM2HPZ1R0MJ0□	—	1μH ±20%	1MHz	1.5A(Ambient temp.85°C) 1.1A(Ambient temp.125°C)	0.09Ω±25%	70MHz
LQM2HPZ2R2MJ0□	—	2.2μH ±20%	1MHz	1A(Ambient temp.85°C) 0.75A(Ambient temp.125°C)	0.12Ω±25%	40MHz
LQM2HPZ3R3MJ0□	—	3.3μH ±20%	1MHz	1A(Ambient temp.85°C) 0.75A(Ambient temp.125°C)	0.12Ω±25%	30MHz

Operating temp.range: -55 to 125°C

Class of Magnetic Shield: Ferrite Core

\*S.R.F: Self Resonant Frequency

Please consider 'Notice (Rating).' When rated current is applied to the products, the temperature rise caused by self-generated heat shall be limited to 40°C max.

### Inductance-Frequency Characteristics (Typ.)

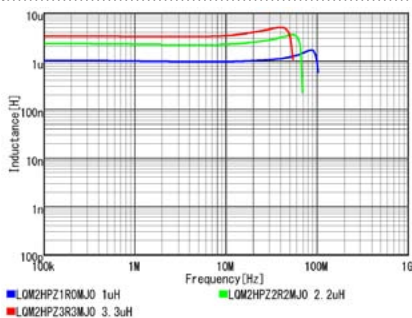

### Inductance-Current Characteristics (Typ.)

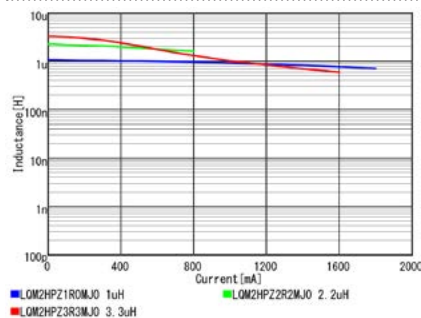

### Temperature Rise Characteristics (Typ.)

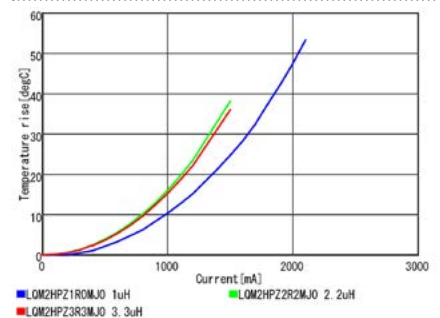

Continued on the following page. ↗

Continued from the preceding page. ↘

### Notice(Rating)

In operating temperatures exceeding +85°C, derating of current is necessary for this series.

Please apply the derating curve shown in the chart according to the operating temperature.

#### Derating of Rated Current

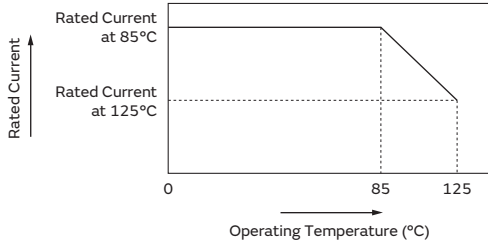

## Inductors for Power Lines

# LQW21FT\_0H Series 0805 (2012) inch (mm)

### Specifications Sheet (with cautions/mounting/packaging)

Infotainment	—
Powertrain/Safety	<a href="https://search.murata.co.jp/Ceramy/image/img/P02/JELF243A-9155.pdf">https://search.murata.co.jp/Ceramy/image/img/P02/JELF243A-9155.pdf</a>

### Appearance/Dimensions

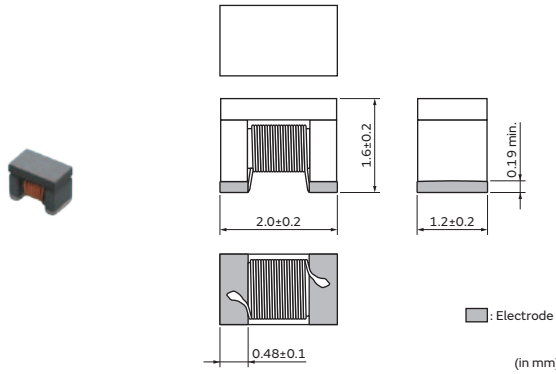

### Packaging

Code	Packaging	Minimum Quantity
L	ø180mm Embossed Taping	1500
B	Packing in Bulk	500

### Rated Value (□: packaging code)

Part Number		Inductance	Inductance Test Frequency	Rated Current (I <sub>sat</sub> )*	Rated Current (I <sub>temp</sub> )*	Max. of DC Resistance	S.R.F.* (min.)
Infotainment	Powertrain/Safety						
—	LQW21FTR47MOH□	0.47μH ±20%	1MHz	1000mA	1100mA(Ambient temp.105°C) 900mA(Ambient temp.125°C)	0.05Ω	470MHz
—	LQW21FTR82MOH□	0.82μH ±20%	1MHz	800mA	800mA(Ambient temp.105°C) 700mA(Ambient temp.125°C)	0.09Ω	360MHz
—	LQW21FT1R0MOH□	1μH ±20%	1MHz	700mA	700mA(Ambient temp.105°C) 600mA(Ambient temp.125°C)	0.13Ω	320MHz
—	LQW21FT1R5MOH□	1.5μH ±20%	1MHz	550mA	550mA(Ambient temp.105°C) 500mA(Ambient temp.125°C)	0.18Ω	260MHz
—	LQW21FT2R0MOH□	2μH ±20%	1MHz	450mA	450mA(Ambient temp.105°C) 400mA(Ambient temp.125°C)	0.29Ω	230MHz

Operating temp.range: -40 to 125°C

Class of Magnetic Shield: Ferrite Core

Only for reflow soldering

\*I<sub>sat</sub>: Rated Current based on Inductance change

\*I<sub>temp</sub>: Rated Current based on Temperature rise

\*S.R.F.: Self Resonant Frequency

### Inductance-Frequency Characteristics (Typ.)

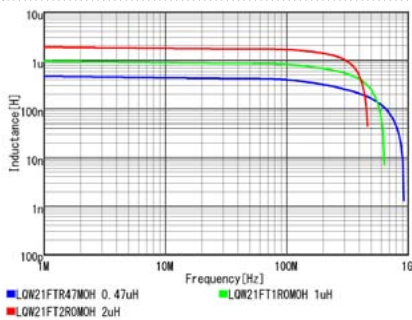

### Impedance-Frequency Characteristics (Typ.)

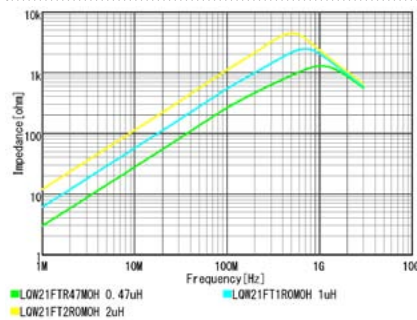

Continued on the following page. ↗

Continued from the preceding page. ↘

## Notice(Rating)

In operating temperatures exceeding +105°C, derating of current is necessary for this series.  
Please apply the derating curve shown in the chart according to the operating temperature.

### Derating of Rated Current

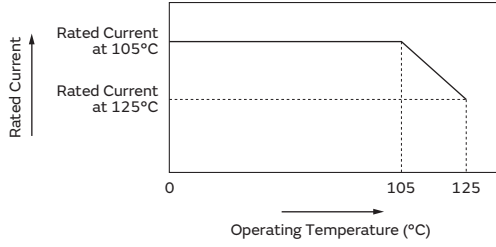

## Inductors for Power Lines

# LQW32FT\_0H Series 1210 (3225) inch (mm)

### Specifications Sheet (with cautions/mounting/packaging)

Infotainment	—
Powertrain/Safety	<a href="https://search.murata.co.jp/Ceramy/image/img/P02/JELF243A-9147.pdf">https://search.murata.co.jp/Ceramy/image/img/P02/JELF243A-9147.pdf</a>

### Appearance/Dimensions

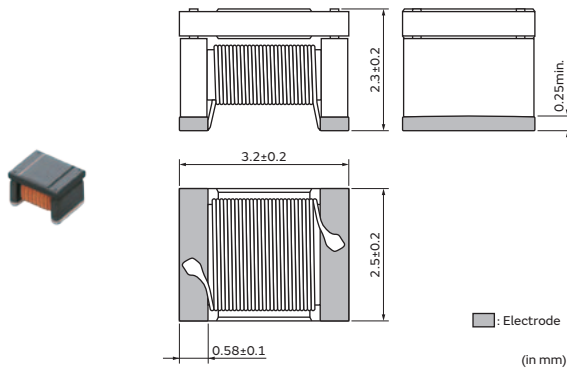

### Packaging

Code	Packaging	Minimum Quantity
L	ø180mm Embossed Taping	1500
B	Packing in Bulk	500

### Rated Value (□: packaging code)

Part Number		Inductance	Inductance Test Frequency	Rated Current (Isat)*	Rated Current (Itemp)*	Max. of DC Resistance	S.R.F* (min.)
Infotainment	Powertrain/Safety						
—	LQW32FT2R2M0H□	2.2μH ±20%	1MHz	1000mA	1000mA(Ambient temp.85°C) 880mA(Ambient temp.105°C) 520mA(Ambient temp.125°C)	0.19Ω	200MHz
—	LQW32FT2R7M0H□	2.7μH ±20%	1MHz	975mA	975mA(Ambient temp.85°C) 860mA(Ambient temp.105°C) 510mA(Ambient temp.125°C)	0.22Ω	200MHz
—	LQW32FT3R3M0H□	3.3μH ±20%	1MHz	950mA	950mA(Ambient temp.85°C) 840mA(Ambient temp.105°C) 500mA(Ambient temp.125°C)	0.24Ω	150MHz
—	LQW32FT4R7M0H□	4.7μH ±20%	1MHz	850mA	850mA(Ambient temp.85°C) 720mA(Ambient temp.105°C) 400mA(Ambient temp.125°C)	0.28Ω	100MHz
—	LQW32FT100M0H□	10μH ±20%	1MHz	500mA	700mA(Ambient temp.85°C) 620mA(Ambient temp.105°C) 360mA(Ambient temp.125°C)	0.4Ω	100MHz
—	LQW32FT220M0H□	22μH ±20%	1MHz	400mA	550mA(Ambient temp.85°C) 500mA(Ambient temp.105°C) 280mA(Ambient temp.125°C)	0.62Ω	50MHz
—	LQW32FT470M0H□	47μH ±20%	1MHz	300mA	500mA(Ambient temp.85°C) 300mA(Ambient temp.105°C) 100mA(Ambient temp.125°C)	0.9Ω	30MHz

Operating temp.range: -40 to 125°C

Class of Magnetic Shield: Ferrite Core

Only for reflow soldering

\*Isat: Rated Current based on Inductance change

\*Itemp: Rated Current based on Temperature rise

\*S.R.F: Self Resonant Frequency

Please consider 'Notice (Rating)'. When rated current is applied to the products, inductance will be within ±30% of nominal inductance. Keep the temperature (ambient temperature plus self-generation of heat) under 125°C. When rated current is applied to the products, the temperature rise caused by self-generated heat shall be limited to 40°C max. Rated current is derated as following figure depending on the operating temperature.

Continued on the following page. ↗

Continued from the preceding page. ↘

**Inductance-Frequency Characteristics (Typ.)**

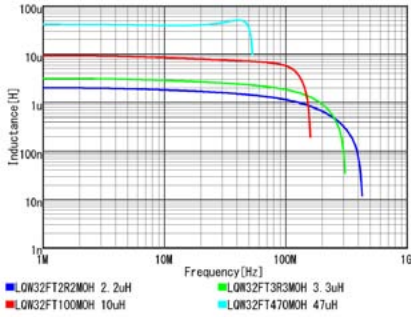

**Impedance-Frequency Characteristics (Typ.)**

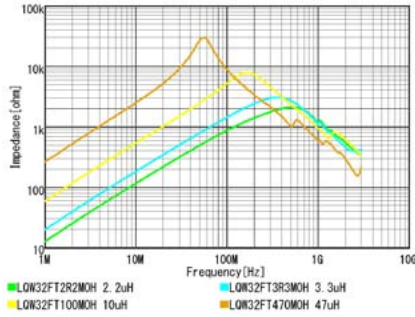

**Notice(Rating)**

In operating temperatures exceeding +85°C, derating of current is necessary for this series.  
 Please apply the derating curve shown in the chart according to the operating temperature.

**Derating of Rated Current**

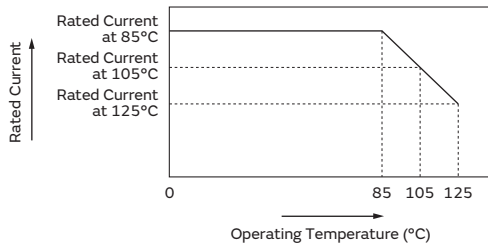

## Inductors for Power Lines (LQ Series) ⚠️Caution/Notice

### ⚠️Caution

#### Rating

##### 1. About the Rated Current

Do not use products beyond the rated current as this may create excessive heat and deteriorate the insulation resistance.

For the usage of powertrain and safety be sure to provide an appropriate fail-safe function on your product to prevent a secondary damage occurrence that may be caused by the abnormal function or the failure of our product.

##### 2. About Excessive Surge Current

Surge current (pulse current or rush current) greater than the specified rated current applied to the product may cause a critical failure, such as an open circuit or burnout caused by excessive temperature rise.

Please contact us in advance with surge current related questions.

### Notice

#### Soldering and Mounting

This product is designed to be mounted by soldering. If you want to use other mounting methods, such as using a conductive adhesive, please consult us beforehand. Also, if repeatedly subjected to temperature cycles or other thermal stress, due to the difference in the coefficient of thermal expansion with the mounting substrate, the solder (solder fillet part) in the mounting part may crack. The occurrence of cracks due to thermal stress is affected by the size of the land where mounted, the solder volume, and the heat dissipation of the mounting substrate. Care should be used when a large change in ambient temperature is a possibility.

#### Storage and Operating Condition

##### 1. Operating Environment

Do not use products in chemical atmosphere such as chlorine gas, acid or sulfide gas.

##### 2. Storage Period

LQM series should be used within 6 months; the other products should be used within 12 months. Check solderability if this period is exceeded.

##### 3. Storage Conditions

- (1) Store products in a warehouse in compliance with the following conditions:  
Temperature: -10 to +40°C.  
Humidity: 15 to 85% (relative humidity)

Do not subject products to rapid changes in temperature and humidity.

Do not store them in chemical atmosphere such as one containing sulfurous acid gas or alkaline gas. This will prevent electrode oxidation, which causes poor solderability and possible corrosion of inductors.

- (2) Do not store products in bulk packaging to prevent collision among inductors, which causes core chipping and wire breakage.
- (3) Store products on pallets to protect from humidity, dust, etc.
- (4) Avoid heat shock, vibration, direct sunlight, etc.

Continued on the following page. ↗



## Inductors for Power Lines (LQ Series) ⚠Caution/Notice

Continued from the preceding page. ↘

### Handling

This item is designed to have sufficient strength, but handle with care to avoid chipping or breaking its ceramic structure.

#### LQH\_D/G/J/M/N/P/T/P\_26 Series

- To prevent breaking the wire, avoid touching with sharp material, such as tweezers or the bristles of a cleaning brush, to the wire wound portion of this product.
- To prevent breaking the core, avoid applying excessive mechanical shock to products mounted on the board.
- Temperature may rise up to max. 40°C when applying the rated current to Inductors for Power Lines. Be careful of the temperature rating of the circuit board and components around the chip Inductors.

#### LQM Series

- There is the possibility that magnetism may change the inductance value. Do not use a magnet or tweezers with magnetism when handling chip inductors. (The tip of the tweezers should be molded with resin or pottery.)
- When the excessive current over rated current is applied, it may cause the inductance value to change due to magnetism.

#### <Transportation>

Do not apply excessive vibration or mechanical shock to products.

#### <Resin Coating>

When coating products with resin, the relatively high resin curing stress may change inductance values. For exterior coating, select resin carefully so that electrical and mechanical performance of the product is not affected. Prior to use, please evaluate reliability with the product mounted in your application set.

(LQH Series)

An open circuit issue may occur by mechanical stress caused by the resin, amount/cured shape of resin, or operating conditions, etc. Some resins containing impurities or chloride may possibly generate chlorine by hydrolysis under some operating conditions, causing corrosion of the inductor wire and leading to an open circuit.

### Cleaning

The following conditions should be observed when cleaning chip inductors (chip coils):

- (1) Cleaning temperature: 60°C max. (40°C max. for alcohol cleaning agents)
- (2) Ultrasonic  
Output: 20W/l max.  
Duration: 5 minutes max.  
Frequency: 28 to 40kHz  
Care should be taken not to cause resonance of the PCB and mounted products.

#### <Rated Current>

(LQH2HP\_JR Series • LQH44P\_GR Series)

Inductance will be more than the value, which is 30% down from minimum rated Inductance value.

(Other LQH\_P Series)

Inductance will be within ±30% of nominal Inductance value.

#### <Based on Temperature Rise>

For LQH\_P series, rated current is set to keep temperature rise caused by self heating 40°C or less.

For other Inductors for Power Lines, please refer to individual specifications.

#### <Handling of a Substrate>

After mounting products on a substrate, do not apply any stress to the product caused by bending or twisting the substrate when cropping the substrate, inserting and removing a connector from the substrate, or tightening a screw to the substrate.

Excessive mechanical stress may cause cracking in the Product.



#### <About Corrosive Gases>

Please refrain from use since contact with environments with corrosive gases (sulfur gas [hydrogen sulfide, sulfur dioxide, etc.], chlorine, ammonia, etc.) or oils (cutting oil, silicone oil, etc.) that have come into contact with the previously stated corrosive gas environment will result in deterioration of product quality or an open from deterioration due to corrosion of product electrode, etc. We will not bear any responsibility for use under these environments.

#### (3) Cleaning agent

The following cleaning agents have been tested on individual components. Evaluation in complete assembly should be done prior to production.

- (a) Alcohol cleaning agents  
Isopropyl alcohol (IPA)
- (b) Aqueous cleaning agents  
Pine Alpha ST-100S

#### (4) Ensure that flux residue is completely removed.

Component should be thoroughly dried after aqueous agents have been removed with deionized water.

For additional cleaning methods, please contact Murata.

## Inductors for Power Lines (except for LQ Series) ⚠️Caution/Notice

### ⚠️Caution

#### Rating

##### 1. About the Rated Current

Do not use products beyond the rated current as this may create excessive heat and deteriorate the insulation resistance.

Be sure to provide an appropriate fail-safe function on your product to prevent a secondary damage occurrence that may be caused by the abnormal function or the failure of our product.

##### 2. About Excessive Surge Current

Surge current (pulse current or rush current) greater than the specified rated current applied to the product may cause a critical failure, such as an open circuit or burnout caused by excessive temperature rise. Please contact us in advance in case with any surge current related questions.

### Notice

#### Soldering and Mounting

This product is designed to be mounted by soldering. If you want to use other mounting methods, such as using a conductive adhesive, please consult us beforehand.

Metal alloy inductor product\*

Metal alloy inductor product\* employs a core with low insulation resistance compared to conventional ferrite coils, so that please pay strict attention with usage.

Metal alloy inductor product\*:

DFE201612P\_D, DFE252012P\_D, DFE2HCAH\_J0,  
DFE2MCAH\_J0, DFE322520F\_D

- Do not make any through holes and copper pattern under the coil. except a copper pattern to the electrode.
- Design/mount any components not to contact this product.

For reflow soldering, pre-heating should be in such a way that the temperature difference between solder and product surface is limited to 100°C max. Cooling into solvent after soldering also should be in such a way that the temperature difference is limited to 100°C max. Insufficient pre-heating may cause cracks on the product, resulting in the deterioration of product quality.

#### Handling

##### 1. Resin Coating

The inductance value may change and/or it may impact the product's performance due to high cure-stress of resin to be used for coating / molding products. So please pay careful attention when you select resin. Prior to use, please make the reliability evaluation with the product mounted in your application set.

- ##### 2. Temperature Rating of the Circuit Board with components mounted may see a temperature rise up to max. 40°C when applying the rated current to the products.
- Be careful of the temperature rating of the circuit board and components.

##### 3. Caution for Use

There is possibility that the Impedance value may change due to magnetism. Don't use a magnet or a pair of tweezers with magnetism when chip coils are handled. (The tip of the tweezers should be molded with resin or pottery.)

##### 4. Magnetic Saturation

When the excessive current or overrated current is applied, the impedance value may change due to magnetism.

##### 5. Handling of a Substrate

After mounting products on a substrate, do not apply any stress to the product caused by bending or twisting to the substrate when cropping the substrate, inserting and removing a connector from the substrate or tightening the screw to the substrate.

Excessive mechanical stress may cause cracking in the product.

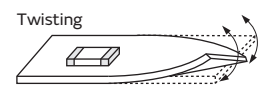
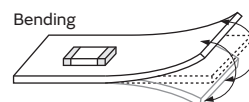

Continued on the following page. ↗

## Inductors for Power Lines (except for LQ Series) ⚠Caution/Notice

Continued from the preceding page. ↘

### 6. About Corrosive Gases

Please refrain from use since contact with environments with corrosive gases (sulfur gas [hydrogen sulfide, sulfur dioxide, etc.], chlorine, ammonia, etc.) or oils (cutting oil, silicone oil, etc.) that have come into contact with the previously stated corrosive gas environment will result in deterioration of product quality or an open from deterioration due to corrosion of product electrode, etc. We will not bear any responsibility for use under these environments.

### 7. Storage and Handling Requirements

#### (1) Storage period

Use the products within 6 months after delivered.  
Solderability should be checked if this period is exceeded.

#### (2) Storage conditions

- Products should be stored in the warehouse with the following conditions.  
Temperature: -10 to 40°C  
Humidity: 15 to 85% relative humidity No rapid change with temperature and humidity.

Don't keep products in corrosive gases such as sulfur, chlorine gas or acid, or it may cause oxidization of electrode, resulting in poor solderability.

- Products should not be stored on bulk packaging condition to prevent the chipping of the core and the breaking of winding wire caused by the collision between the products.
- Products should be stored on the palette for the prevention of the influence from humidity, dust, etc.
- Products should be stored in the warehouse without heat shock, vibration, direct sunlight and so on.

#### (3) Handling condition

Care should be taken when transporting or handling product to avoid excessive vibration or mechanical shock.

## ● Part Numbering

### Inductors for General Circuits for Automotive

(Part Number) 

LQ	H	43	N	Z	4R7	M	0	3	L
①	②	③	④	⑤	⑥	⑦	⑧	⑨	⑩

#### ① Product ID

Product ID	
LQ	Chip Inductors (Chip Coils)

#### ② Structure

Code	Structure
H	Wire Wound Type (Ferrite Core)

#### ③ Dimensions (LxW)

Code	Nominal Dimensions (LxW)	Size Code (in inch)
32	3.2x2.5mm	1210
43	4.5x3.2mm	1812

#### ④ Applications and Characteristics

Code	Applications and Characteristics
N	for Resonant Circuit

#### ⑤ Category

Code	Category	
H	Automotive	Powertrain/Safety
Z	Automotive	Infotainment

#### ⑥ Inductance

Expressed by three-digit alphanumerics. The unit is micro-henry ( $\mu\text{H}$ ). The first and second figures are significant digits, and the third figure expresses the number of zeros that follow the two figures. If there is a decimal point, it is expressed by the capital letter "R." In this case, all figures are significant digits. If inductance is less than  $0.1\mu\text{H}$ , the inductance code is expressed by a combination of two figures and the capital letter "N," and the unit of inductance is nano-henry (nH). The capital letter "N" indicates the unit of "nH," and also expresses a decimal point. In this case, all figures are significant digits. For those products whose inductance values are specified using three designated digits, these values may be indicated using the closest two digits instead.

#### ⑦ Inductance Tolerance

Code	Inductance Tolerance
J	$\pm 5\%$
K	$\pm 10\%$
M	$\pm 20\%$

#### ⑧ Features

Code	Features
0/2	Standard Type

#### ⑨ Electrode

•Lead (Pb) Free

Code	Electrode
3	LF Solder

#### ⑩ Packaging

Code	Packaging
K	Embossed Taping ( $\phi 330\text{mm}$ Reel)
L	Embossed Taping ( $\phi 180\text{mm}$ Reel)

# Inductors for General Circuits

## LQH31HZ\_03 Series 1206 (3216) inch (mm)

### Specifications Sheet (with cautions/mounting/packaging)

Infotainment	<a href="https://search.murata.co.jp/Ceramy/image/img/P02/JELF243A-9122.pdf">https://search.murata.co.jp/Ceramy/image/img/P02/JELF243A-9122.pdf</a>
Powertrain/Safety	—

### Appearance/Dimensions

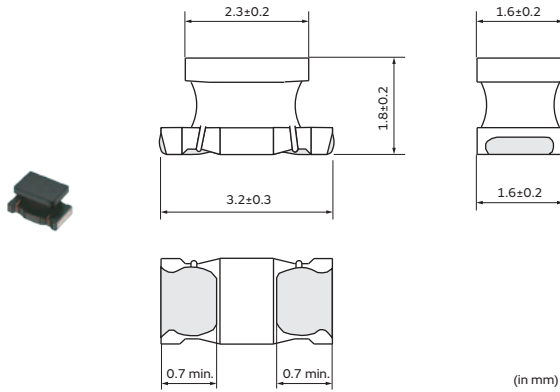

### Packaging

Code	Packaging	Minimum Quantity
K	ø330mm Embossed Taping	7500
L	ø180mm Embossed Taping	2000

### Rated Value (□: packaging code)

Part Number		Inductance	Inductance Test Frequency	Q (min.)	Q Test Frequency	Rated Current	DC Resistance	S.R.F* (min.)
Infotainment	Powertrain/Safety							
LQH31HZ54NK03□	—	54nH ±10%	1MHz	50	100MHz	920mA	0.035Ω±30%	800MHz
LQH31HZ95NK03□	—	95nH ±10%	1MHz	60	100MHz	790mA	0.047Ω±30%	650MHz
LQH31HZR14J03□	—	145nH ±5%	1MHz	60	100MHz	700mA	0.061Ω±30%	500MHz
LQH31HZR14K03□	—	145nH ±10%	1MHz	60	100MHz	700mA	0.061Ω±30%	500MHz
LQH31HZR21J03□	—	215nH ±5%	1MHz	60	100MHz	520mA	0.11Ω±30%	430MHz
LQH31HZR21K03□	—	215nH ±10%	1MHz	60	100MHz	520mA	0.11Ω±30%	430MHz
LQH31HZR29J03□	—	290nH ±5%	1MHz	60	100MHz	420mA	0.17Ω±30%	360MHz
LQH31HZR29K03□	—	290nH ±10%	1MHz	60	100MHz	420mA	0.17Ω±30%	360MHz
LQH31HZR39J03□	—	390nH ±5%	1MHz	60	100MHz	330mA	0.26Ω±30%	300MHz
LQH31HZR39K03□	—	390nH ±10%	1MHz	60	100MHz	330mA	0.26Ω±30%	300MHz
LQH31HZR50J03□	—	500nH ±5%	1MHz	60	100MHz	260mA	0.44Ω±30%	270MHz
LQH31HZR50K03□	—	500nH ±10%	1MHz	60	100MHz	260mA	0.44Ω±30%	270MHz
LQH31HZR61J03□	—	610nH ±5%	1MHz	60	100MHz	250mA	0.48Ω±30%	240MHz
LQH31HZR61K03□	—	610nH ±10%	1MHz	60	100MHz	250mA	0.48Ω±30%	240MHz
LQH31HZR75J03□	—	750nH ±5%	1MHz	60	100MHz	190mA	0.79Ω±30%	220MHz
LQH31HZR75K03□	—	750nH ±10%	1MHz	60	100MHz	190mA	0.79Ω±30%	220MHz
LQH31HZR88J03□	—	880nH ±5%	1MHz	60	100MHz	180mA	0.86Ω±30%	200MHz
LQH31HZR88K03□	—	880nH ±10%	1MHz	60	100MHz	180mA	0.86Ω±30%	200MHz

Operating temp.range (Self-temp.rise not included): -40 to 85°C

\*S.R.F: Self Resonant Frequency

### Inductance-Frequency Characteristics (Typ.)

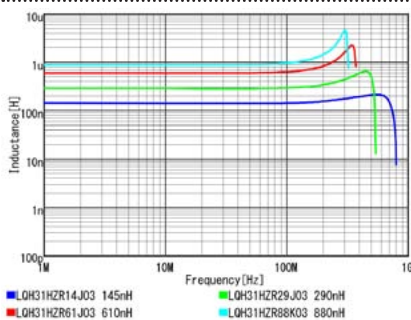

### Q-Frequency Characteristics (Typ.)

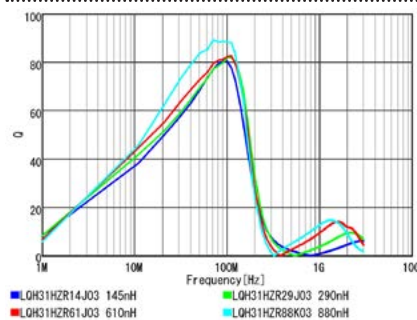

# Inductors for General Circuits

## LQH32NZ\_23/LQH32NH\_23 Series 1210 (3225) inch (mm)

### Specifications Sheet (with cautions/mounting/packaging)

Infotainment	<a href="https://search.murata.co.jp/Ceramy/image/img/P02/JELF243A-9144.pdf">https://search.murata.co.jp/Ceramy/image/img/P02/JELF243A-9144.pdf</a>
Powertrain/Safety	<a href="https://search.murata.co.jp/Ceramy/image/img/P02/JELF243A-9146.pdf">https://search.murata.co.jp/Ceramy/image/img/P02/JELF243A-9146.pdf</a>

### Appearance/Dimensions

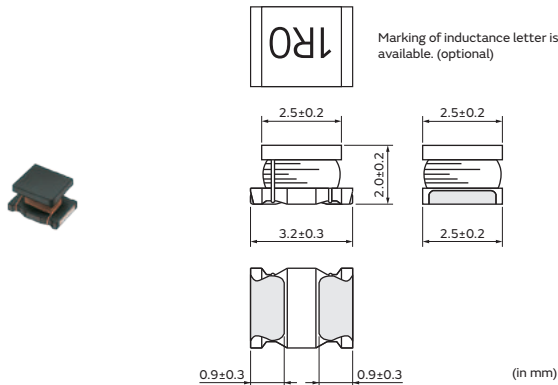

### Packaging

Code	Packaging	Minimum Quantity
K	ø330mm Embossed Taping	7500
L	ø180mm Embossed Taping	2000

### Rated Value (□: packaging code)

Part Number		Inductance	Inductance Test Frequency	Q (min.)	Q Test Frequency	Rated Current	Max. of DC Resistance	DC Resistance	S.R.F* (min.)	Operating temp.range
Infotainment	Powertrain/Safety									
LQH32NZ1R0K23□	—	1μH ±10%	1MHz	20	1MHz	445mA	0.5Ω	-	100MHz	-40 to 105°C
—	LQH32NH1R0M23□	1μH ±20%	1MHz	25	1MHz	780mA	-	0.06Ω±20%	100MHz	-40 to 125°C
LQH32NZ1R2K23□	—	1.2μH ±10%	1MHz	20	1MHz	425mA	0.6Ω	-	100MHz	-40 to 105°C
—	LQH32NH1R2J23□	1.2μH ±5%	1MHz	25	1MHz	720mA	-	0.07Ω±20%	90MHz	-40 to 125°C
LQH32NZ1R5K23□	—	1.5μH ±10%	1MHz	20	1MHz	400mA	0.6Ω	-	75MHz	-40 to 105°C
—	LQH32NH1R5J23□	1.5μH ±5%	1MHz	25	1MHz	675mA	-	0.08Ω±20%	85MHz	-40 to 125°C
LQH32NZ1R8K23□	—	1.8μH ±10%	1MHz	20	1MHz	390mA	0.7Ω	-	60MHz	-40 to 105°C
—	LQH32NH1R8J23□	1.8μH ±5%	1MHz	25	1MHz	635mA	-	0.09Ω±20%	80MHz	-40 to 125°C
LQH32NZ2R2K23□	—	2.2μH ±10%	1MHz	20	1MHz	370mA	0.8Ω	-	50MHz	-40 to 105°C
—	LQH32NH2R2J23□	2.2μH ±5%	1MHz	25	1MHz	610mA	-	0.097Ω±20%	75MHz	-40 to 125°C
LQH32NZ2R7K23□	—	2.7μH ±10%	1MHz	20	1MHz	320mA	0.9Ω	-	43MHz	-40 to 105°C
—	LQH32NH2R7J23□	2.7μH ±5%	1MHz	25	1MHz	495mA	-	0.15Ω±20%	70MHz	-40 to 125°C
LQH32NZ3R3K23□	—	3.3μH ±10%	1MHz	20	1MHz	300mA	1Ω	-	38MHz	-40 to 105°C
—	LQH32NH3R3J23□	3.3μH ±5%	1MHz	25	1MHz	425mA	-	0.20Ω±20%	65MHz	-40 to 125°C
LQH32NZ3R9K23□	—	3.9μH ±10%	1MHz	20	1MHz	290mA	1.1Ω	-	35MHz	-40 to 105°C
—	LQH32NH3R9J23□	3.9μH ±5%	1MHz	25	1MHz	510mA	-	0.14Ω±20%	60MHz	-40 to 125°C
LQH32NZ4R7K23□	—	4.7μH ±10%	1MHz	20	1MHz	270mA	1.2Ω	-	31MHz	-40 to 105°C
—	LQH32NH4R7J23□	4.7μH ±5%	1MHz	25	1MHz	420mA	-	0.21Ω±20%	55MHz	-40 to 125°C
LQH32NZ5R6K23□	—	5.6μH ±10%	1MHz	20	1MHz	250mA	1.3Ω	-	28MHz	-40 to 105°C
—	LQH32NH5R6J23□	5.6μH ±5%	1MHz	25	1MHz	335mA	-	0.32Ω±20%	50MHz	-40 to 125°C
LQH32NZ6R8K23□	—	6.8μH ±10%	1MHz	20	1MHz	240mA	1.5Ω	-	25MHz	-40 to 105°C
—	LQH32NH6R8J23□	6.8μH ±5%	1MHz	25	1MHz	315mA	-	0.36Ω±20%	45MHz	-40 to 125°C
LQH32NZ8R2K23□	—	8.2μH ±10%	1MHz	20	1MHz	225mA	1.6Ω	-	23MHz	-40 to 105°C
—	LQH32NH8R2J23□	8.2μH ±5%	1MHz	25	1MHz	300mA	-	0.40Ω±20%	40MHz	-40 to 125°C
LQH32NZ100J23□	LQH32NH100J23□	10μH ±5%	1MHz	35	1MHz	190mA/325mA	-	0.34Ω±20%	20MHz/35MHz	-40 to 105°C/-40 to 125°C
LQH32NZ120J23□	LQH32NH120J23□	12μH ±5%	1MHz	35	1MHz	180mA/270mA	-	0.50Ω±20%	18MHz/30MHz	-40 to 105°C/-40 to 125°C
LQH32NZ150J23□	LQH32NH150J23□	15μH ±5%	1MHz	35	1MHz	170mA/270mA	-	0.50Ω±20%	16MHz/25MHz	-40 to 105°C/-40 to 125°C

Class of Magnetic Shield: No Shield

Only for reflow soldering

\*S.R.F: Self Resonant Frequency

When rated current is applied to the products, self-temperature rise shall be limited to 20°C max and inductance will be within ±10% of initial inductance value.

Continued on the following page. ↗

Continued from the preceding page. ↘

Part Number		Inductance	Inductance Test Frequency	Q (min.)	Q Test Frequency	Rated Current	Max. of DC Resistance	DC Resistance	S.R.F* (min.)	Operating temp.range
Infotainment	Powertrain/Safety									
LQH32NZ180J23	LQH32NH180J23	18μH ±5%	1MHz	35	1MHz	165mA/235mA	-	0.64Ω±20%	15MHz/25MHz	-40 to 105°C/-40 to 125°C
LQH32NZ220J23	LQH32NH220J23	22μH ±5%	1MHz	35	1MHz	150mA/220mA	-	0.74Ω±20%	14MHz/20MHz	-40 to 105°C/-40 to 125°C
LQH32NZ270J23	LQH32NH270J23	27μH ±5%	1MHz	35	1MHz	125mA/190mA	-	1.00Ω±20%	13MHz/20MHz	-40 to 105°C/-40 to 125°C
LQH32NZ330J23	LQH32NH330J23	33μH ±5%	1MHz	40	1MHz	115mA/175mA	-	1.14Ω±20%	12MHz/20MHz	-40 to 105°C/-40 to 125°C
LQH32NZ390J23	LQH32NH390J23	39μH ±5%	1MHz	40	1MHz	110mA/170mA	-	1.27Ω±20%	11MHz/16MHz	-40 to 105°C/-40 to 125°C
LQH32NZ470J23	LQH32NH470J23	47μH ±5%	1MHz	40	1MHz	100mA/155mA	-	1.46Ω±20%	11MHz/15MHz	-40 to 105°C/-40 to 125°C
LQH32NZ560J23	LQH32NH560J23	56μH ±5%	1MHz	40	1MHz	85mA/130mA	-	2.00Ω±20%	10MHz/13MHz	-40 to 105°C/-40 to 125°C
LQH32NZ680J23	LQH32NH680J23	68μH ±5%	1MHz	40	1MHz	80mA/125mA	-	2.25Ω±20%	9MHz/12MHz	-40 to 105°C/-40 to 125°C
LQH32NZ820J23	LQH32NH820J23	82μH ±5%	1MHz	40	1MHz	70mA/100mA	-	3.25Ω±20%	8.5MHz/11MHz	-40 to 105°C/-40 to 125°C
LQH32NZ101J23	LQH32NH101J23	100μH ±5%	1MHz	40	796kHz	80mA/95mA	-	3.65Ω±20%	8MHz/10MHz	-40 to 105°C/-40 to 125°C
LQH32NZ121J23	LQH32NH121J23	120μH ±5%	1MHz	40	796kHz	75mA/85mA	-	4.20Ω±20%	7.5MHz/10MHz	-40 to 105°C/-40 to 125°C
LQH32NZ151J23	LQH32NH151J23	150μH ±5%	1MHz	40	796kHz	70mA/80mA	-	4.85Ω±20%	7MHz/8MHz	-40 to 105°C/-40 to 125°C
LQH32NZ181J23	LQH32NH181J23	180μH ±5%	1MHz	40	796kHz	65mA/60mA	-	7.60Ω±20%	6MHz	-40 to 105°C/-40 to 125°C
LQH32NZ221J23	LQH32NH221J23	220μH ±5%	1MHz	40	796kHz	65mA/60mA	-	8.45Ω±20%	5.5MHz	-40 to 105°C/-40 to 125°C
LQH32NZ271J23	LQH32NH271J23	270μH ±5%	1MHz	40/50	796kHz	65mA/55mA	-	9.70Ω±20%	5MHz	-40 to 105°C/-40 to 125°C
LQH32NZ331J23	LQH32NH331J23	330μH ±5%	1MHz	40/50	796kHz	65mA/50mA	-	11.0Ω±20%	5MHz	-40 to 105°C/-40 to 125°C
LQH32NZ391J23	LQH32NH391J23	390μH ±5%	1MHz	50	796kHz	50mA/45mA	-	12.4Ω±20%	5MHz	-40 to 105°C/-40 to 125°C
LQH32NZ471J23	LQH32NH471J23	470μH ±5%	1kHz	50	796kHz	45mA/40mA	-	14.1Ω±20%	5MHz	-40 to 105°C/-40 to 125°C
—	LQH32NH561J23	560μH ±5%	1kHz	50	796kHz	40mA	-	14.6Ω±20%	4MHz	-40 to 125°C

Class of Magnetic Shield: No Shield

Only for reflow soldering

\*S.R.F: Self Resonant Frequency

When rated current is applied to the products, self-temperature rise shall be limited to 20°C max and inductance will be within ±10% of initial inductance value.

### Inductance-Frequency Characteristics (Typ.)

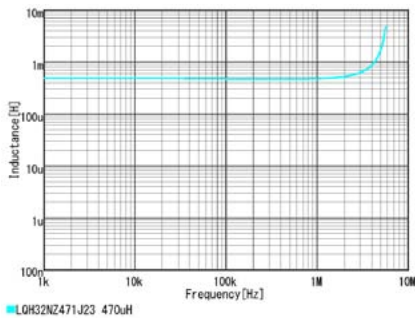

### Q-Frequency Characteristics (Typ.)

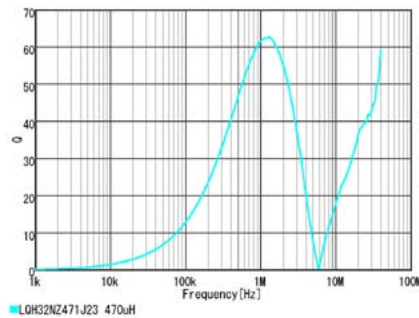

Chip Ferrite Bead

Chip EMI/FIL

Chip Common Mode Choke Coil

Block Type EMI/FIL

Microchip Transformer (Balun)

Inductors for Power Lines

Inductors for General Circuits

RF Inductors



# Inductors for General Circuits

## LQH43NZ\_03/LQH43NH\_03 Series 1812 (4532) inch (mm)

### Specifications Sheet (with cautions/mounting/packaging)

Infotainment	<a href="https://search.murata.co.jp/Ceramy/image/img/P02/JELF243A-9125.pdf">https://search.murata.co.jp/Ceramy/image/img/P02/JELF243A-9125.pdf</a>
Powertrain/Safety	<a href="https://search.murata.co.jp/Ceramy/image/img/P02/JELF243A-9150.pdf">https://search.murata.co.jp/Ceramy/image/img/P02/JELF243A-9150.pdf</a>

### Appearance/Dimensions

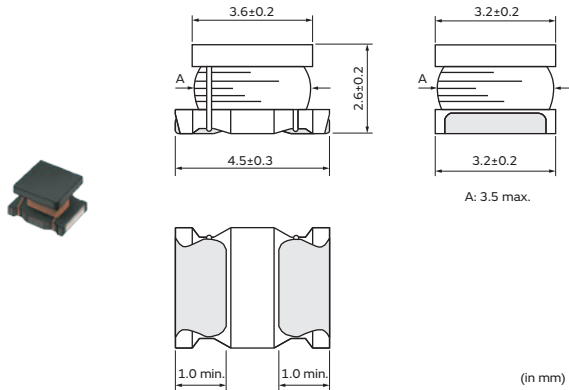

### Packaging

Code	Packaging	Minimum Quantity
K	ø330mm Embossed Taping	2500
L	ø180mm Embossed Taping	500

### Rated Value (□: packaging code)

Part Number		Inductance	Inductance Test Frequency	Q (min.)	Q Test Frequency	Rated Current	Max. of DC Resistance	DC Resistance	S.R.F* (min.)	Operating temp.range	Remark
Infotainment	Powertrain/Safety										
LQH43NZ1R0M03□	LQH43NH1R0M03□	1μH ±20%	1MHz	20	1MHz	500mA/1300mA	-	0.033Ω±20%	120MHz	-40 to 105°C/-40 to 125°C	*1
LQH43NZ1R2M03□	—	1.2μH ±20%	1MHz	20	1MHz	500mA	0.2Ω	-	100MHz	-40 to 105°C	*2
—	LQH43NH1R2K03□	1.2μH ±10%	1MHz	20	1MHz	1100mA	-	0.043Ω±20%	100MHz	-40 to 125°C	*3
LQH43NZ1R5M03□	—	1.5μH ±20%	1MHz	20	1MHz	500mA	0.3Ω	-	85MHz	-40 to 105°C	*2
—	LQH43NH1R5J03□	1.5μH ±5%	1MHz	20	1MHz	1000mA	-	0.049Ω±20%	85MHz	-40 to 125°C	*3
LQH43NZ1R8M03□	—	1.8μH ±20%	1MHz	20	1MHz	500mA	0.3Ω	-	75MHz	-40 to 105°C	*2
—	LQH43NH1R8J03□	1.8μH ±5%	1MHz	20	1MHz	1050mA	-	0.043Ω±20%	75MHz	-40 to 125°C	*3
LQH43NZ2R2M03□	—	2.2μH ±20%	1MHz	20	1MHz	500mA	0.3Ω	-	62MHz	-40 to 105°C	*2
—	LQH43NH2R2J03□	2.2μH ±5%	1MHz	20	1MHz	1000mA	-	0.049Ω±20%	62MHz	-40 to 125°C	*3
LQH43NZ2R7M03□	—	2.7μH ±20%	1MHz	20	1MHz	500mA	0.32Ω	-	53MHz	-40 to 105°C	*2
—	LQH43NH2R7J03□	2.7μH ±5%	1MHz	20	1MHz	950mA	-	0.053Ω±20%	53MHz	-40 to 125°C	*3
LQH43NZ3R3M03□	—	3.3μH ±20%	1MHz	20	1MHz	500mA	0.35Ω	-	47MHz	-40 to 105°C	*2
—	LQH43NH3R3J03□	3.3μH ±5%	1MHz	20	1MHz	800mA	-	0.077Ω±20%	47MHz	-40 to 125°C	*3
LQH43NZ3R9M03□	—	3.9μH ±20%	1MHz	20	1MHz	500mA	0.38Ω	-	41MHz	-40 to 105°C	*2
—	LQH43NH3R9J03□	3.9μH ±5%	1MHz	20	1MHz	650mA	-	0.12Ω±20%	41MHz	-40 to 125°C	*3
LQH43NZ4R7K03□	—	4.7μH ±10%	1MHz	30	1MHz	500mA	0.4Ω	-	38MHz	-40 to 105°C	*2
LQH43NZ4R7M03□	—	4.7μH ±20%	1MHz	30	1MHz	500mA	0.4Ω	-	38MHz	-40 to 105°C	*2
—	LQH43NH4R7J03□	4.7μH ±5%	1MHz	20	1MHz	750mA	-	0.09Ω±20%	38MHz	-40 to 125°C	*3
LQH43NZ5R6K03□	—	5.6μH ±10%	1MHz	30	1MHz	500mA	0.47Ω	-	33MHz	-40 to 105°C	*2
LQH43NZ5R6M03□	—	5.6μH ±20%	1MHz	30	1MHz	500mA	0.47Ω	-	33MHz	-40 to 105°C	*2
—	LQH43NH5R6J03□	5.6μH ±5%	1MHz	25	1MHz	650mA	-	0.11Ω±20%	33MHz	-40 to 125°C	*3
LQH43NZ6R8K03□	—	6.8μH ±10%	1MHz	30	1MHz	450mA	0.5Ω	-	31MHz	-40 to 105°C	*2
LQH43NZ6R8M03□	—	6.8μH ±20%	1MHz	30	1MHz	450mA	0.5Ω	-	31MHz	-40 to 105°C	*2
—	LQH43NH6R8J03□	6.8μH ±5%	1MHz	30	1MHz	530mA	-	0.18Ω±20%	31MHz	-40 to 125°C	*3
LQH43NZ8R2K03□	—	8.2μH ±10%	1MHz	30	1MHz	450mA	0.56Ω	-	27MHz	-40 to 105°C	*2

Class of Magnetic Shield: No Shield

Only for reflow soldering

\*S.R.F: Self Resonant Frequency

\*1: When rated current is applied to the products, self-temperature rise shall be limited to 20°C max and inductance will be within ±10% of initial inductance value./When rated current is applied to the products, self-temperature rise shall be limited to 20°C max and inductance will be within ±10% of nominal value.

\*2: When rated current is applied to the products, self-temperature rise shall be limited to 20°C max and inductance will be within ±10% of initial inductance value.

\*3: When rated current is applied to the products, self-temperature rise shall be limited to 20°C max and inductance will be within ±10% of nominal value.

Continued on the following page. ↗



Continued from the preceding page. ↘

Part Number		Inductance	Inductance Test Frequency	Q (min.)	Q Test Frequency	Rated Current	Max. of DC Resistance	DC Resistance	S.R.F.* (min.)	Operating temp.range	Remark
Infotainment	Powertrain/Safety										
LQH43NZ8R2M03□	—	8.2μH ±20%	1MHz	30	1MHz	450mA	0.56Ω	-	27MHz	-40 to 105°C	*2
—	LQH43NH8R2J03□	8.2μH ±5%	1MHz	30	1MHz	530mA	-	0.18Ω±20%	27MHz	-40 to 125°C	*3
LQH43NZ100J03□	LQH43NH100J03□	10μH ±5%	1MHz	35	1MHz	400mA/480mA	-	0.2Ω±20%	23MHz	-40 to 105°C/-40 to 125°C	*1
LQH43NZ100K03□	—	10μH ±10%	1MHz	35	1MHz	400mA	0.56Ω	-	23MHz	-40 to 105°C	*2
LQH43NZ120J03□	LQH43NH120J03□	12μH ±5%	1MHz	35	1MHz	380mA/420mA	-	0.25Ω±20%	21MHz	-40 to 105°C/-40 to 125°C	*1
LQH43NZ120K03□	—	12μH ±10%	1MHz	35	1MHz	380mA	0.62Ω	-	21MHz	-40 to 105°C	*2
LQH43NZ150J03□	LQH43NH150J03□	15μH ±5%	1MHz	35	1MHz	360mA/390mA	-	0.3Ω±20%	19MHz	-40 to 105°C/-40 to 125°C	*1
LQH43NZ150K03□	—	15μH ±10%	1MHz	35	1MHz	360mA	0.73Ω	-	19MHz	-40 to 105°C	*2
LQH43NZ180J03□	LQH43NH180J03□	18μH ±5%	1MHz	35	1MHz	340mA/365mA	-	0.35Ω±20%	17MHz	-40 to 105°C/-40 to 125°C	*1
LQH43NZ180K03□	—	18μH ±10%	1MHz	35	1MHz	340mA	0.82Ω	-	17MHz	-40 to 105°C	*2
LQH43NZ220J03□	LQH43NH220J03□	22μH ±5%	1MHz	35	1MHz	320mA/300mA	-	0.47Ω±20%	15MHz	-40 to 105°C/-40 to 125°C	*1
LQH43NZ220K03□	—	22μH ±10%	1MHz	35	1MHz	320mA	0.94Ω	-	15MHz	-40 to 105°C	*2
LQH43NZ270J03□	LQH43NH270J03□	27μH ±5%	1MHz	35	1MHz	300mA/280mA	-	0.6Ω±20%	14MHz	-40 to 105°C/-40 to 125°C	*1
LQH43NZ270K03□	—	27μH ±10%	1MHz	35	1MHz	300mA	1.1Ω	-	14MHz	-40 to 105°C	*2
LQH43NZ330J03□	LQH43NH330J03□	33μH ±5%	1MHz	35	1MHz	270mA/250mA	-	0.7Ω±20%	12MHz	-40 to 105°C/-40 to 125°C	*1
LQH43NZ330K03□	—	33μH ±10%	1MHz	35	1MHz	270mA	1.2Ω	-	12MHz	-40 to 105°C	*2
LQH43NZ390J03□	LQH43NH390J03□	39μH ±5%	1MHz	35	1MHz	240mA/230mA	-	0.8Ω±20%	11MHz	-40 to 105°C/-40 to 125°C	*1
LQH43NZ390K03□	—	39μH ±10%	1MHz	35	1MHz	240mA	1.4Ω	-	11MHz	-40 to 105°C	*2
LQH43NZ470J03□	LQH43NH470J03□	47μH ±5%	1MHz	35	1MHz	220mA/210mA	-	0.87Ω±20%	10MHz	-40 to 105°C/-40 to 125°C	*1
LQH43NZ470K03□	—	47μH ±10%	1MHz	35	1MHz	220mA	1.5Ω	-	10MHz	-40 to 105°C	*2
LQH43NZ560J03□	LQH43NH560J03□	56μH ±5%	1MHz	35	1MHz	200mA/180mA	-	1.34Ω±20%	9.3MHz	-40 to 105°C/-40 to 125°C	*1
LQH43NZ560K03□	—	56μH ±10%	1MHz	35	1MHz	200mA	1.7Ω	-	9.3MHz	-40 to 105°C	*2
LQH43NZ680J03□	LQH43NH680J03□	68μH ±5%	1MHz	35	1MHz	180mA/170mA	-	1.52Ω±20%	8.4MHz	-40 to 105°C/-40 to 125°C	*1
LQH43NZ680K03□	—	68μH ±10%	1MHz	35	1MHz	180mA	1.9Ω	-	8.4MHz	-40 to 105°C	*2
LQH43NZ820J03□	LQH43NH820J03□	82μH ±5%	1MHz	35	1MHz	170mA/165mA	-	1.7Ω±20%	7.5MHz	-40 to 105°C/-40 to 125°C	*1
LQH43NZ820K03□	—	82μH ±10%	1MHz	35	1MHz	170mA	2.2Ω	-	7.5MHz	-40 to 105°C	*2
LQH43NZ101J03□	LQH43NH101J03□	100μH ±5%	1MHz	40	796kHz	160mA/150mA	-	2Ω±20%	6.8MHz	-40 to 105°C/-40 to 125°C	*1
LQH43NZ101K03□	—	100μH ±10%	1MHz	40	796kHz	160mA	2.5Ω	-	6.8MHz	-40 to 105°C	*2
LQH43NZ121J03□	LQH43NH121J03□	120μH ±5%	1MHz	40	796kHz	150mA/130mA	-	2.6Ω±20%	6.2MHz	-40 to 105°C/-40 to 125°C	*1
LQH43NZ121K03□	—	120μH ±10%	1MHz	40	796kHz	150mA	3Ω	-	6.2MHz	-40 to 105°C	*2
LQH43NZ151J03□	LQH43NH151J03□	150μH ±5%	1MHz	40	796kHz	130mA/120mA	-	3Ω±20%	5.5MHz	-40 to 105°C/-40 to 125°C	*1
LQH43NZ151K03□	—	150μH ±10%	1MHz	40	796kHz	130mA	3.7Ω	-	5.5MHz	-40 to 105°C	*2
LQH43NZ181J03□	LQH43NH181J03□	180μH ±5%	1MHz	40	796kHz	120mA/110mA	-	3.4Ω±20%	5MHz	-40 to 105°C/-40 to 125°C	*1
LQH43NZ181K03□	—	180μH ±10%	1MHz	40	796kHz	120mA	4.5Ω	-	5MHz	-40 to 105°C	*2
LQH43NZ221J03□	LQH43NH221J03□	220μH ±5%	1MHz	40	796kHz	110mA/100mA	-	3.8Ω±20%	4.5MHz	-40 to 105°C/-40 to 125°C	*1
LQH43NZ221K03□	—	220μH ±10%	1MHz	40	796kHz	110mA	5.4Ω	-	4.5MHz	-40 to 105°C	*2
LQH43NZ271J03□	LQH43NH271J03□	270μH ±5%	1MHz	40	796kHz	100mA/90mA	-	5.5Ω±20%	4MHz	-40 to 105°C/-40 to 125°C	*1
LQH43NZ271K03□	—	270μH ±10%	1MHz	40	796kHz	100mA	6.8Ω	-	4MHz	-40 to 105°C	*2
LQH43NZ331J03□	LQH43NH331J03□	330μH ±5%	1MHz	40	796kHz	95mA/85mA	-	6.2Ω±20%	3.6MHz	-40 to 105°C/-40 to 125°C	*1
LQH43NZ331K03□	—	330μH ±10%	1MHz	40	796kHz	95mA	8.2Ω	-	3.6MHz	-40 to 105°C	*2
LQH43NZ391J03□	LQH43NH391J03□	390μH ±5%	1MHz	40	796kHz	90mA/80mA	-	6.9Ω±20%	3.3MHz	-40 to 105°C/-40 to 125°C	*1
LQH43NZ391K03□	—	390μH ±10%	1MHz	40	796kHz	90mA	9.7Ω	-	3.3MHz	-40 to 105°C	*2
LQH43NZ471J03□	LQH43NH471J03□	470μH ±5%	1kHz	40	796kHz	80mA/75mA	-	7.8Ω±20%	3MHz	-40 to 105°C/-40 to 125°C	*1
LQH43NZ471K03□	—	470μH ±10%	1kHz	40	796kHz	80mA	11.8Ω	-	3MHz	-40 to 105°C	*2
LQH43NZ561J03□	LQH43NH561J03□	560μH ±5%	1kHz	40	796kHz	70mA/60mA	-	11.3Ω±20%	2.7MHz	-40 to 105°C/-40 to 125°C	*1
LQH43NZ561K03□	—	560μH ±10%	1kHz	40	796kHz	70mA	14.5Ω	-	2.7MHz	-40 to 105°C	*2
LQH43NZ681J03□	LQH43NH681J03□	680μH ±5%	1kHz	40	796kHz	65mA/55mA	-	12.9Ω±20%	2.5MHz	-40 to 105°C/-40 to 125°C	*1
LQH43NZ681K03□	—	680μH ±10%	1kHz	40	796kHz	65mA	17Ω	-	2.5MHz	-40 to 105°C	*2
LQH43NZ821J03□	LQH43NH821J03□	820μH ±5%	1kHz	40	796kHz	60mA/50mA	-	14.5Ω±20%	2.2MHz	-40 to 105°C/-40 to 125°C	*1
LQH43NZ821K03□	—	820μH ±10%	1kHz	40	796kHz	60mA	20.5Ω	-	2.2MHz	-40 to 105°C	*2

Class of Magnetic Shield: No Shield

Only for reflow soldering

\*S.R.F: Self Resonant Frequency

\*1: When rated current is applied to the products, self-temperature rise shall be limited to 20°C max and inductance will be within ±10% of initial inductance value./When rated current is applied to the products, self-temperature rise shall be limited to 20°C max and inductance will be within ±10% of nominal value.

\*2: When rated current is applied to the products, self-temperature rise shall be limited to 20°C max and inductance will be within ±10% of initial inductance value.

\*3: When rated current is applied to the products, self-temperature rise shall be limited to 20°C max and inductance will be within ±10% of nominal value.

Continued on the following page. ↗

Continued from the preceding page. ↘

Part Number		Inductance	Inductance Test Frequency	Q (min.)	Q Test Frequency	Rated Current	Max. of DC Resistance	DC Resistance	S.R.F* (min.)	Operating temp.range	Remark
Infotainment	Powertrain/Safety										
LQH43NZ102J03□	LQH43NH102J03□	1000μH ±5%	1kHz	40	252kHz	50mA/45mA	-	15.5Ω±20%	2MHz	-40 to 105°C/-40 to 125°C	*1
LQH43NZ102K03□	—	1000μH ±10%	1kHz	40	252kHz	50mA	25Ω	-	2MHz	-40 to 105°C	*2
LQH43NZ122J03□	LQH43NH122J03□	1200μH ±5%	1kHz	40	252kHz	45mA/40mA	-	20.3Ω±20%	1.8MHz	-40 to 105°C/-40 to 125°C	*1
LQH43NZ122K03□	—	1200μH ±10%	1kHz	40	252kHz	45mA	30Ω	-	1.8MHz	-40 to 105°C	*2
LQH43NZ152J03□	LQH43NH152J03□	1500μH ±5%	1kHz	40	252kHz	40mA/35mA	-	23.7Ω±20%	1.6MHz	-40 to 105°C/-40 to 125°C	*1
LQH43NZ152K03□	—	1500μH ±10%	1kHz	40	252kHz	40mA	37Ω	-	1.6MHz	-40 to 105°C	*2
LQH43NZ182J03□	LQH43NH182J03□	1800μH ±5%	1kHz	40	252kHz	35mA	-	26.7Ω±20%	1.5MHz	-40 to 105°C/-40 to 125°C	*1
LQH43NZ182K03□	—	1800μH ±10%	1kHz	40	252kHz	35mA	45Ω	-	1.5MHz	-40 to 105°C	*2
LQH43NZ222J03□	LQH43NH222J03□	2200μH ±5%	1kHz	40	252kHz	30mA	-	30.6Ω±20%	1.3MHz	-40 to 105°C/-40 to 125°C	*1
LQH43NZ222K03□	—	2200μH ±10%	1kHz	40	252kHz	30mA	50Ω	-	1.3MHz	-40 to 105°C	*2
LQH43NZ242J03□	—	2400μH ±5%	1kHz	40	252kHz	25mA	53Ω	-	1.2MHz	-40 to 105°C	*2
LQH43NZ242K03□	—	2400μH ±10%	1kHz	40	252kHz	25mA	53Ω	-	1.2MHz	-40 to 105°C	*2

Class of Magnetic Shield: No Shield

Only for reflow soldering

\*S.R.F: Self Resonant Frequency

\*1: When rated current is applied to the products, self-temperature rise shall be limited to 20°C max and inductance will be within ±10% of initial inductance value./When rated current is applied to the products, self-temperature rise shall be limited to 20°C max and inductance will be within ±10% of nominal value.

\*2: When rated current is applied to the products, self-temperature rise shall be limited to 20°C max and inductance will be within ±10% of initial inductance value.

\*3: When rated current is applied to the products, self-temperature rise shall be limited to 20°C max and inductance will be within ±10% of nominal value.

### Inductance-Frequency Characteristics (Typ.)

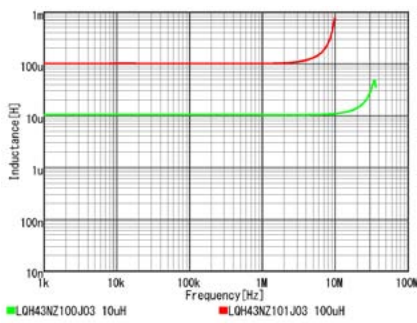

### Q-Frequency Characteristics (Typ.)

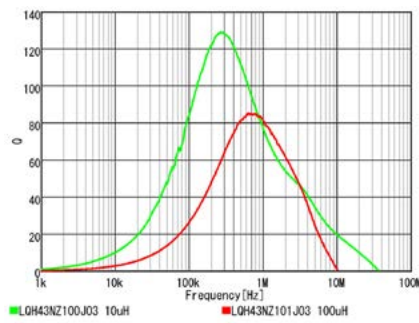

# Inductors for General Circuits

## HEAWS Series 4241 (107104) inch (mm)

### Specifications Sheet (with cautions/mounting/packaging)

Infotainment	<a href="https://search.murata.co.jp/Ceramy/image/img/P02/J(E)TE243C-9109_HEAWS_reference.pdf">https://search.murata.co.jp/Ceramy/image/img/P02/J(E)TE243C-9109_HEAWS_reference.pdf</a>
Powertrain/Safety	—

### Appearance/Dimensions

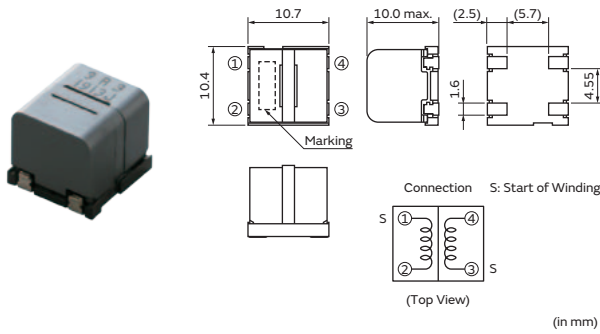

### Packaging

Code	Packaging	Minimum Quantity
=P3	ø330mm Embossed Taping	250

### Rated Value (□: packaging code)

Part Number		Inductance	Inductance Test Frequency	Rated Current	Max. of DC Resistance
Infotainment	Powertrain/Safety				
HEAWS-100M□	—	10μH ±20%	0.1MHz	2800mA	0.025Ω
HEAWS-3R3N□	—	3.3μH ±30%	0.1MHz	5300mA	0.01Ω

Operating temp.range (Self-temp.rise included): -40 to 125°C

Only for reflow soldering

Rated current (Isat) is specified when the decrease of the initial inductance value at 25%.

Rated current (Itemp) is specified when temperature of inductor the is raised 40°C by DC current.

Class of Magnetic Shield: Ferrite Core

### Inductance-Frequency Characteristics (Typ.)

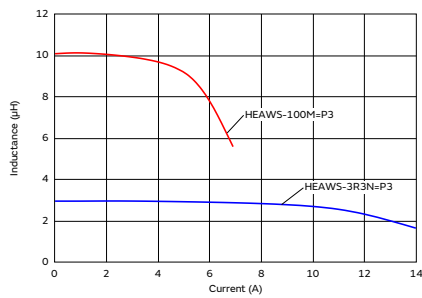

### Temperature Rise Characteristics (Typ.)

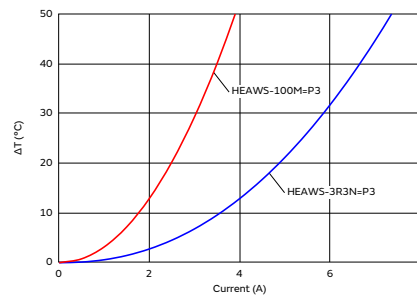

## Inductors for General Circuits

# Surface mount variable coil 5CCEG Series 2222 (5656) inch (mm)

### Specifications Sheet (with cautions/mounting/packaging)

Infotainment	<a href="https://www.murata.com/-/media/webrenewal/products/inductor/variable/te243c-0106_5cceg_reference.ashx?la=ja-JP&amp;cvid=2020070101000000000">https://www.murata.com/-/media/webrenewal/products/inductor/variable/te243c-0106_5cceg_reference.ashx?la=ja-JP&amp;cvid=2020070101000000000</a>
Powertrain/Safety	—

### Appearance/Dimensions

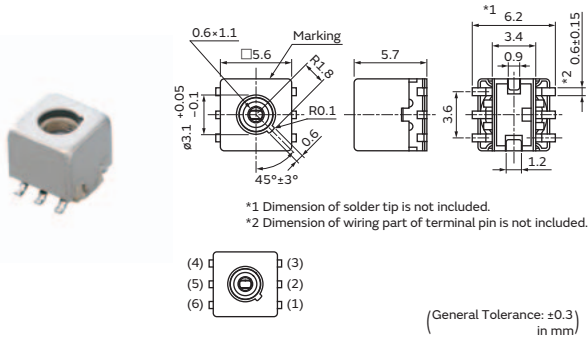

### Packaging

Code	Packaging	Minimum Quantity
=P3	ø330mm Embossed Taping	750

### Features

- 6.5×5.9×6.0(H) mm MAX.
- Supported inductance range: 0.05 to 2.7μH
- High reliability that conforms to automotive standards
- Operating temperature range: -40°C to +85°C

### Applications

- Ideal for use as RF matching transformers for car tuners

### Rated Value (□: packaging code)

Winding Connection (Bottom View)	Part Number		Test Frequency (MHz)	Resonance Capacitor Range (pF)
	Infotainment	Powertrain/Safety		
	#A1313B-0029GGH□	—	100	11.4 +3/-3%
	#A1313B-0030GRG□	—	100	11.4 +5/-2%
	#A1313B-0031GRG□	—	100	11.4 +2/-4%
	#A1313B-0032GGH□	—	100	11.7 +3/-3%

## Inductors for General Circuits

# Surface mount variable coil FSDVA Series 2323 (5858) inch (mm)

### Specifications Sheet (with cautions/mounting/packaging)

Infotainment	<a href="https://www.murata.com/-/media/webrenewal/products/inductor/variable/te243c-0070_fsdva_reference.ashx?la=ja-jp&amp;cvid=20200820072918000000">https://www.murata.com/-/media/webrenewal/products/inductor/variable/te243c-0070_fsdva_reference.ashx?la=ja-jp&amp;cvid=20200820072918000000</a>
Powertrain/Safety	—

### Appearance/Dimensions

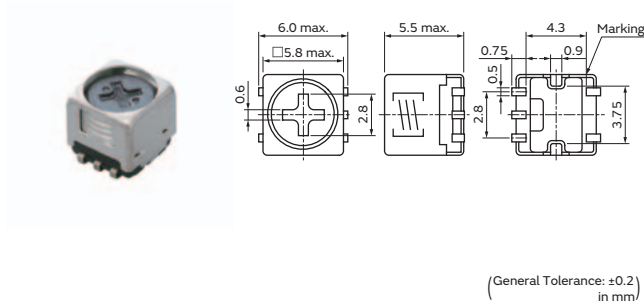

### Packaging

Code	Packaging	Minimum Quantity
=P3	ø330mm Embossed Taping	1000

### Features

- 5.8×5.8×5.5(H) mm MAX.
- Supported inductance range: 0.1 to 52mH (1 to 7 mH for corner sensor applications)
- Resistant to mechanical stress
- Operating temperature range
  - Up to 20 mH (-40°C to +105°C)
  - 20 mH or more (-40°C to +85°C)
- Various reliability conditions guaranteed for 1,000 hours (evaluation performed up to 3,000 hours)
- Lead coplanarity guaranteed within 0.1 mm

### Rated Value (□: packaging code)

Winding Connection (Bottom View)	Part Number		Test Frequency (kHz)	Inductance Range (mH)	Unloaded Q
	Infotainment	Powertrain/Safety			
	N1342JC-0143UG□	—	252	4.4 ±3%	25 min
	N1342LE-0144BQE□	—	252	2.5 ±5%	25 min

## Inductors for General Circuits (LQ Series) ⚠️Caution/Notice

### ⚠️Caution

#### Rating

##### 1. About the Rated Current

Do not use products beyond the rated current as this may create excessive heat and deteriorate the insulation resistance.

For the usage of powertrain and safety be sure to provide an appropriate fail-safe function on your product to prevent a secondary damage occurrence that may be caused by the abnormal function or the failure of our product.

##### 2. About Excessive Surge Current

Surge current (pulse current or rush current) greater than the specified rated current applied to the product may cause a critical failure, such as an open circuit or burnout caused by excessive temperature rise.

Please contact us in advance with any surge current related questions.

### Notice

#### Mounting Conditions

These products are designed to be mounted by soldering. If you want to use other mounting methods, such as using a conductive adhesive, please consult us beforehand.

Also, if repeatedly subjected to temperature cycles or other thermal stress, due to the difference in the coefficient of thermal expansion with the mounting substrate, the solder (solder fillet part) in the mounting part may crack.

The occurrence of cracks due to thermal stress is affected by the size of the land where mounted, the solder volume, and the heat dissipation of the mounting substrate.

Care should be used when a large change in ambient temperature is assumed.

Check the mounting condition before using. Using mounting conditions (nozzles, equipment conditions, etc.) that are not suitable for products may lead to pick up errors, misalignment, or damage to the product

#### Storage and Operating Condition

##### 1. Operating Environment

Do not use products in chemical atmosphere such as chlorine gas, acid or sulfide gas.

##### 2. Storage Period

Products should be used within 12 months.  
Check solderability if this period is exceeded.

##### 3. Storage Conditions

(1) Store products in a warehouse in compliance with the following conditions:  
Temperature: -10 to +40 degrees C.  
Humidity: 15 to 85% (relative humidity)

Do not subject products to rapid changes in temperature and humidity.

Do not store them in chemical atmosphere such as one containing sulfurous acid gas or alkaline gas. This will prevent electrode oxidation, which causes poor solderability and possible corrosion of inductors.

- (2) Do not store products in bulk packaging to prevent collision among inductors, which causes core chipping and wire breakage.
- (3) Store products on pallets to protect from humidity, dust, etc.
- (4) Avoid heat shock, vibration, direct sunlight, etc.

#### Handling

This item is designed to have sufficient strength, but handle with care to avoid chipping or breaking its ceramic structure.

LQH series

• To prevent breaking the wire, avoid touching with sharp material, such as tweezers or the bristles of a cleaning brush, to the wire wound portion of this product.

• To prevent breaking the core, avoid applying excessive mechanical shock to products mounted on the board.

<Transportation>

Do not apply excessive vibration or mechanical shock to products.

Continued on the following page. ↗

## Inductors for General Circuits (LQ Series) ⚠Caution/Notice

Continued from the preceding page. ↘

### <Resin Coating>

When coating products with resin, the relatively high resin curing stress may change inductance values. For exterior coating, select resin carefully so that electrical and mechanical performance of the product is not affected. Prior to use, please evaluate reliability with the product mounted in your application set. (LQH series)

An open circuit issue may occur by mechanical stress caused by the resin, amount/cured shape of resin, or operating conditions, etc. Some resins containing impurities or chloride may possibly generate chlorine by hydrolysis under some operating conditions, causing corrosion of the inductor wire and leading to an open circuit.

### <Handling of a Substrate>

After mounting products on a substrate, do not apply any stress to the product caused by bending or twisting the substrate when cropping the substrate, inserting and removing a connector from the substrate, or tightening a screw to the substrate. Excessive mechanical stress may cause cracking in the Product.

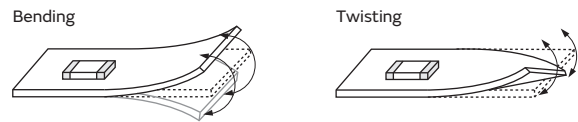

## About Corrosive Gases

Please refrain from use since contact with environments with corrosive gases (sulfur gas [hydrogen sulfide, sulfur dioxide, etc.], chlorine, ammonia, etc.) or oils (cutting oil, silicone oil, etc.) that have come into contact with the previously stated corrosive gas environment will result in deterioration of product quality or an open from deterioration due to corrosion of product electrode, etc. We will not bear any responsibility for use under these environments.

## Cleaning

The following conditions should be observed when cleaning chip inductors (chip coils):

- (1) Cleaning temperature: 60°C max. (40°C max. for alcohol cleaning agents)
- (2) Ultrasonic  
Output: 20W/l max.  
Duration: 5 minutes max.  
Frequency: 28 to 40kHz  
Care should be taken not to cause resonance of the PCB and mounted products.

### (3) Cleaning agent

The following cleaning agents have been tested on individual components. Evaluation in complete assembly should be done prior to production.

- (a) Alcohol cleaning agents  
Isopropyl alcohol (IPA)
- (b) Aqueous cleaning agents  
Pine Alpha ST-100S

### (4) Ensure that flux residue is completely removed.

Component should be thoroughly dried after aqueous agents have been removed with deionized water.

For additional cleaning methods, please contact Murata.



## Inductors for General (except for LQ Series) ⚠️Caution/Notice

### ⚠️Caution

#### Rating

##### 1. About the Rated Current

Do not use products beyond the rated current as this may create excessive heat and deteriorate the insulation resistance.

Be sure to provide an appropriate fail-safe function on your product to prevent a second damage that may be caused by the abnormal function or the failure of our product.

##### 2. About Excessive Surge Current

Surge current (pulse current or rush current) greater than the specified rated current applied to the product may cause a critical failure, such as an open circuit, burnout caused by excessive temperature rise. Please contact us in advance in case of applying the surge current.

### Notice

#### Soldering and Mounting

If repeatedly subjected to temperature cycles or other thermal stress, due to the difference in the coefficient of thermal expansion with the mounting substrate, the solder (solder fillet part) in the mounting part may crack.

The occurrence of cracks due to thermal stress is affected by the size of the land where mounted, the solder volume, and the heat dissipation of the mounting substrate.

Care should be used when a large change in ambient temperature is a possibility.

Check the mounting condition before using. Using mounting conditions (nozzles, equipment conditions, etc.) that are not suitable for products may lead to pick up errors, misalignment, or damage to the product.

(1) The part must be pre-heated before soldering if reflow is applied.

The difference between pre-heat temperature and soldering temperature must be within 150°C.

(2) If a soldering iron is applied, the soldering process must be completed within 3 seconds at a soldering temperature lower than 350°C.

The tip of the soldering iron must not touch the terminal electrode in this process.

(3) Terminals should not be handled with fingers. This is to prevent deterioration in solderability.

(4) Soldering using a soldering iron must be done only once for each part.

(5) PCB mount: this part must be handled with care to minimize any physical stress to the part at the board assembly process.

(6) To minimize the influence to the part, the thickness of PCB, land dimension, and the amount of solder must be evaluated carefully by individual application.

(7) If a washing process is applied, please make sure there is no problem with operating.

(8) Products should not be dropped on the floor. This is to prevent damage to the products.

(9) Although electrical performance is satisfactory, audible noises may be made if audio frequency ingredient is contained in current.

Before using, please make sure there aren't any problem with operating.

#### Handling

##### <Storage and Handling Requirements>

###### (1) Storage period

Use the products within 6 months after delivered.

Solderability should be checked if this period is exceeded

###### (2) Storage conditions

• Products should be stored in the warehouse on the following conditions.

Temperature: -10 to 40°C

Humidity: 15 to 85% relative humidity No rapid change on temperature and humidity

Don't keep products in corrosive gases such as sulfur, chlorine gas or acid, or it may cause oxidization of electrode, resulting in poor solderability.

• Products should not be stored on bulk packaging condition to prevent the chipping of the core and the breaking of winding wire caused by the collision between the products.

• Products should be stored on the palette for the prevention of the influence from humidity, dust and so on.

• Products should be stored in the warehouse without heat shock, vibration, direct sunlight and so on.

###### (3) Handling condition

Care should be taken when transporting or handling product to avoid excessive vibration or mechanical shock.

Continued on the following page. ↗



## Inductors for General (except for LQ Series) ⚠Caution/Notice

Continued from the preceding page. ↘

### About Corrosive Gases

Please refrain from use since contact with environments with corrosive gases (sulfur gas [hydrogen sulfide, sulfur dioxide, etc.], chlorine, ammonia, etc.) or oils (cutting oil, silicone oil, etc.) that have come into contact with the previously stated corrosive gas environment will result in deterioration of product quality or an open from deterioration due to corrosion of product electrode, etc. We will not bear any responsibility for use under these environments.

### Cleaning

The following conditions should be observed when cleaning chip inductors (chip coils):

- (1) Cleaning temperature: 60°C max. (40°C max. for alcohol cleaning agents)
- (2) Ultrasonic
  - Output: 20W/l max.
  - Duration: 5 minutes max.
  - Frequency: 28 to 40kHz
  - Care should be taken not to cause resonance of the PCB and mounted products.

#### (3) Cleaning agent

The following cleaning agents have been tested on individual components. Evaluation in complete assembly should be done prior to production.

- (a) Alcohol cleaning agents
  - Isopropyl alcohol (IPA)
- (b) Aqueous cleaning agents
  - Pine Alpha ST-100S

#### (4) Ensure that flux residue is completely removed.

Component should be thoroughly dried after aqueous agents have been removed with deionized water.

For additional cleaning methods, please contact Murata.

## ● Part Numbering

### RF Inductors for Automotive

(Part Number) 

LQ	G	15	H	H	1N0	S	0	2	D
①	②	③	④	⑤	⑥	⑦	⑧	⑨	⑩

#### ① Product ID

Product ID	
LQ	Chip Inductors (Chip Coils)

#### ② Structure

Code	Structure
G	Multilayer Type (Air-core Inductors (Coils))
H	Wire Wound Type (Ferrite Core)
P	Film Type
W	Wire Wound Type (Air-core Inductors (Coils))

#### ③ Dimensions (LxW)

Code	Nominal Dimensions (LxW)	Size Code (in inch)
03	0.6x0.3mm	0201
15	1.0x0.5mm	0402
18	1.6x0.8mm	0603
31	3.2x1.6mm	1206

#### ④ Applications and Characteristics

Code	Series	Applications and Characteristics
H	LQG	Multilayer Air-core Inductors (Coils)
W		High Q Type
T	LQP	Film Type (Low DC Resistance Type)
A	LQW	High Q Type (UHF-SHF)
C		for Choke (Coating Type)
H	LQH	for High-frequency Resonant Circuit

#### ⑤ Category

Code	Series	Category	
N	LQP/LQW	Standard Type	
S	LQW		
Z	LQG/LQH	Automotive	Infotainment
H	LQG		Powertrain/Safety

#### ⑥ Inductance

Expressed by three-digit alphanumerics. The unit is micro-henry ( $\mu\text{H}$ ). The first and second figures are significant digits, and the third figure expresses the number of zeros that follow the two figures. If there is a decimal point, it is expressed by the capital letter "R." In this case, all figures are significant digits. If inductance is less than  $0.1\mu\text{H}$ , the inductance code is expressed by a combination of two figures and the capital letter "N," and the unit of inductance is nano-henry (nH). The capital letter "N" indicates the unit of "nH," and also expresses a decimal point. In this case, all figures are significant digits. For those products whose inductance values are specified using three designated digits, these values may be indicated using the closest two digits instead.

#### ⑦ Inductance Tolerance

Code	Inductance Tolerance
B	$\pm 0.1\text{nH}$
C	$\pm 0.2\text{nH}$
D	$\pm 0.5\text{nH}$
G	$\pm 2\%$
H	$\pm 3\%$
J	$\pm 5\%$
K	$\pm 10\%$
S	$\pm 0.3\text{nH}$

#### ⑧ Features

Code	Features	Series
0	Standard Type	LQG/LQH/LQP/LQW
1	High-Q or Low DC Resistance	LQW15A/15C/18A
8	Low Resistance/ Large Current Type	LQW15A/18A
H	Automotive Powertrain/ Safety	LQP03T
Z	Automotive Infotainment	LQP03T

#### ⑨ Electrode

•Lead (Pb) Free

Code	Electrode	Series
0	Sn	LQG18H
2		LQG15H/LQG15W/LQP03T
3	LF Solder	LQH
Z	Automotive Infotainment	LQW15A/15C/18A/18C

#### ⑩ Packaging

Code	Packaging
K	Embossed Taping ( $\varnothing 330\text{mm}$ Reel)
L	Embossed Taping ( $\varnothing 180\text{mm}$ Reel)
B	Bulk
J	Paper Taping ( $\varnothing 330\text{mm}$ Reel)
D	Paper Taping ( $\varnothing 180\text{mm}$ Reel)

# RF Inductors

## LQG15HZ\_02/LQG15HH\_02 Series 0402 (1005) inch (mm)

### Specifications Sheet (with cautions/mounting/packaging)

Infotainment	<a href="https://search.murata.co.jp/Ceramy/image/img/P02/JELF243B-9110.pdf">https://search.murata.co.jp/Ceramy/image/img/P02/JELF243B-9110.pdf</a>
Powertrain/Safety	<a href="https://search.murata.co.jp/Ceramy/image/img/P02/JELF243B-9101.pdf">https://search.murata.co.jp/Ceramy/image/img/P02/JELF243B-9101.pdf</a>

### Appearance/Dimensions

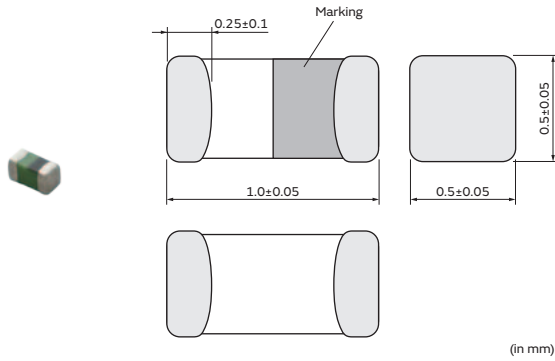

### Packaging

Code	Packaging	Minimum Quantity
D	ø180mm Paper Taping	10000
J	ø330mm Paper Taping	50000
B	Packing in Bulk	1000

### Rated Value (□: packaging code)

Part Number		Inductance	Inductance Test Frequency	Q (min.)	Q Test Frequency	Rated Current	Max. of DC Resistance	S.R.F* (min.)
Infotainment	Powertrain/Safety							
LQG15HZ1N0B02□	LQG15HH1N0B02□	1nH ±0.1nH	100MHz	8	100MHz	1000mA	0.07Ω	10000MHz
LQG15HZ1N0C02□	LQG15HH1N0C02□	1nH ±0.2nH	100MHz	8	100MHz	1000mA	0.07Ω	10000MHz
LQG15HZ1N0S02□	LQG15HH1N0S02□	1nH ±0.3nH	100MHz	8	100MHz	1000mA	0.07Ω	10000MHz
LQG15HZ1N1B02□	LQG15HH1N1B02□	1.1nH ±0.1nH	100MHz	8	100MHz	1000mA	0.07Ω	6000MHz
LQG15HZ1N1C02□	LQG15HH1N1C02□	1.1nH ±0.2nH	100MHz	8	100MHz	1000mA	0.07Ω	6000MHz
LQG15HZ1N1S02□	LQG15HH1N1S02□	1.1nH ±0.3nH	100MHz	8	100MHz	1000mA	0.07Ω	6000MHz
LQG15HZ1N2B02□	LQG15HH1N2B02□	1.2nH ±0.1nH	100MHz	8	100MHz	1000mA	0.07Ω	6000MHz
LQG15HZ1N2C02□	LQG15HH1N2C02□	1.2nH ±0.2nH	100MHz	8	100MHz	1000mA	0.07Ω	6000MHz
LQG15HZ1N2S02□	LQG15HH1N2S02□	1.2nH ±0.3nH	100MHz	8	100MHz	1000mA	0.07Ω	6000MHz
LQG15HZ1N3B02□	LQG15HH1N3B02□	1.3nH ±0.1nH	100MHz	8	100MHz	1000mA	0.07Ω	6000MHz
LQG15HZ1N3C02□	LQG15HH1N3C02□	1.3nH ±0.2nH	100MHz	8	100MHz	1000mA	0.07Ω	6000MHz
LQG15HZ1N3S02□	LQG15HH1N3S02□	1.3nH ±0.3nH	100MHz	8	100MHz	1000mA	0.07Ω	6000MHz
LQG15HZ1N5B02□	LQG15HH1N5B02□	1.5nH ±0.1nH	100MHz	8	100MHz	1000mA	0.07Ω	6000MHz
LQG15HZ1N5C02□	LQG15HH1N5C02□	1.5nH ±0.2nH	100MHz	8	100MHz	1000mA	0.07Ω	6000MHz
LQG15HZ1N5S02□	LQG15HH1N5S02□	1.5nH ±0.3nH	100MHz	8	100MHz	1000mA	0.07Ω	6000MHz
LQG15HZ1N6B02□	LQG15HH1N6B02□	1.6nH ±0.1nH	100MHz	8	100MHz	1000mA	0.07Ω	6000MHz
LQG15HZ1N6C02□	LQG15HH1N6C02□	1.6nH ±0.2nH	100MHz	8	100MHz	1000mA	0.07Ω	6000MHz
LQG15HZ1N6S02□	LQG15HH1N6S02□	1.6nH ±0.3nH	100MHz	8	100MHz	1000mA	0.07Ω	6000MHz
LQG15HZ1N8B02□	LQG15HH1N8B02□	1.8nH ±0.1nH	100MHz	8	100MHz	950mA	0.08Ω	6000MHz
LQG15HZ1N8C02□	LQG15HH1N8C02□	1.8nH ±0.2nH	100MHz	8	100MHz	950mA	0.08Ω	6000MHz
LQG15HZ1N8S02□	LQG15HH1N8S02□	1.8nH ±0.3nH	100MHz	8	100MHz	950mA	0.08Ω	6000MHz
LQG15HZ2N0B02□	LQG15HH2N0B02□	2nH ±0.1nH	100MHz	8	100MHz	900mA	0.09Ω	6000MHz
LQG15HZ2N0C02□	LQG15HH2N0C02□	2nH ±0.2nH	100MHz	8	100MHz	900mA	0.09Ω	6000MHz
LQG15HZ2N0S02□	LQG15HH2N0S02□	2nH ±0.3nH	100MHz	8	100MHz	900mA	0.09Ω	6000MHz
LQG15HZ2N2B02□	LQG15HH2N2B02□	2.2nH ±0.1nH	100MHz	8	100MHz	900mA	0.09Ω	6000MHz
LQG15HZ2N2C02□	LQG15HH2N2C02□	2.2nH ±0.2nH	100MHz	8	100MHz	900mA	0.09Ω	6000MHz
LQG15HZ2N2S02□	LQG15HH2N2S02□	2.2nH ±0.3nH	100MHz	8	100MHz	900mA	0.09Ω	6000MHz
LQG15HZ2N4B02□	LQG15HH2N4B02□	2.4nH ±0.1nH	100MHz	8	100MHz	850mA	0.11Ω	6000MHz

Operating temp.range (Self-temp.rise not included): -55 to 125°C

Only for reflow soldering

\*S.R.F: Self Resonant Frequency

Continued on the following page. ↗

Continued from the preceding page. ↘

Part Number		Inductance	Inductance Test Frequency	Q (min.)	Q Test Frequency	Rated Current	Max. of DC Resistance	S.R.F* (min.)
Infotainment	Powertrain/Safety							
LQG15HZ2N4C02□	LQG15HH2N4C02□	2.4nH ±0.2nH	100MHz	8	100MHz	850mA	0.11Ω	6000MHz
LQG15HZ2N4S02□	LQG15HH2N4S02□	2.4nH ±0.3nH	100MHz	8	100MHz	850mA	0.11Ω	6000MHz
LQG15HZ2N7B02□	LQG15HH2N7B02□	2.7nH ±0.1nH	100MHz	8	100MHz	800mA	0.12Ω	6000MHz
LQG15HZ2N7C02□	LQG15HH2N7C02□	2.7nH ±0.2nH	100MHz	8	100MHz	800mA	0.12Ω	6000MHz
LQG15HZ2N7S02□	LQG15HH2N7S02□	2.7nH ±0.3nH	100MHz	8	100MHz	800mA	0.12Ω	6000MHz
LQG15HZ3N0B02□	LQG15HH3N0B02□	3nH ±0.1nH	100MHz	8	100MHz	800mA	0.125Ω	6000MHz
LQG15HZ3N0C02□	LQG15HH3N0C02□	3nH ±0.2nH	100MHz	8	100MHz	800mA	0.125Ω	6000MHz
LQG15HZ3N0S02□	LQG15HH3N0S02□	3nH ±0.3nH	100MHz	8	100MHz	800mA	0.125Ω	6000MHz
LQG15HZ3N3B02□	LQG15HH3N3B02□	3.3nH ±0.1nH	100MHz	8	100MHz	800mA	0.125Ω	6000MHz
LQG15HZ3N3C02□	LQG15HH3N3C02□	3.3nH ±0.2nH	100MHz	8	100MHz	800mA	0.125Ω	6000MHz
LQG15HZ3N3S02□	LQG15HH3N3S02□	3.3nH ±0.3nH	100MHz	8	100MHz	800mA	0.125Ω	6000MHz
LQG15HZ3N6B02□	LQG15HH3N6B02□	3.6nH ±0.1nH	100MHz	8	100MHz	750mA	0.14Ω	6000MHz
LQG15HZ3N6C02□	LQG15HH3N6C02□	3.6nH ±0.2nH	100MHz	8	100MHz	750mA	0.14Ω	6000MHz
LQG15HZ3N6S02□	LQG15HH3N6S02□	3.6nH ±0.3nH	100MHz	8	100MHz	750mA	0.14Ω	6000MHz
LQG15HZ3N9B02□	LQG15HH3N9B02□	3.9nH ±0.1nH	100MHz	8	100MHz	750mA	0.14Ω	6000MHz
LQG15HZ3N9C02□	LQG15HH3N9C02□	3.9nH ±0.2nH	100MHz	8	100MHz	750mA	0.14Ω	6000MHz
LQG15HZ3N9S02□	LQG15HH3N9S02□	3.9nH ±0.3nH	100MHz	8	100MHz	750mA	0.14Ω	6000MHz
LQG15HZ4N3B02□	LQG15HH4N3B02□	4.3nH ±0.1nH	100MHz	8	100MHz	750mA	0.14Ω	6000MHz
LQG15HZ4N3C02□	LQG15HH4N3C02□	4.3nH ±0.2nH	100MHz	8	100MHz	750mA	0.14Ω	6000MHz
LQG15HZ4N3S02□	LQG15HH4N3S02□	4.3nH ±0.3nH	100MHz	8	100MHz	750mA	0.14Ω	6000MHz
LQG15HZ4N7B02□	LQG15HH4N7B02□	4.7nH ±0.1nH	100MHz	8	100MHz	700mA	0.16Ω	6000MHz
LQG15HZ4N7C02□	LQG15HH4N7C02□	4.7nH ±0.2nH	100MHz	8	100MHz	700mA	0.16Ω	6000MHz
LQG15HZ4N7S02□	LQG15HH4N7S02□	4.7nH ±0.3nH	100MHz	8	100MHz	700mA	0.16Ω	6000MHz
LQG15HZ5N1B02□	LQG15HH5N1B02□	5.1nH ±0.1nH	100MHz	8	100MHz	650mA	0.18Ω	5300MHz
LQG15HZ5N1C02□	LQG15HH5N1C02□	5.1nH ±0.2nH	100MHz	8	100MHz	650mA	0.18Ω	5300MHz
LQG15HZ5N1S02□	LQG15HH5N1S02□	5.1nH ±0.3nH	100MHz	8	100MHz	650mA	0.18Ω	5300MHz
LQG15HZ5N6B02□	LQG15HH5N6B02□	5.6nH ±0.1nH	100MHz	8	100MHz	650mA	0.18Ω	4500MHz
LQG15HZ5N6C02□	LQG15HH5N6C02□	5.6nH ±0.2nH	100MHz	8	100MHz	650mA	0.18Ω	4500MHz
LQG15HZ5N6S02□	LQG15HH5N6S02□	5.6nH ±0.3nH	100MHz	8	100MHz	650mA	0.18Ω	4500MHz
LQG15HZ6N2B02□	LQG15HH6N2B02□	6.2nH ±0.1nH	100MHz	8	100MHz	600mA	0.2Ω	4500MHz
LQG15HZ6N2C02□	LQG15HH6N2C02□	6.2nH ±0.2nH	100MHz	8	100MHz	600mA	0.2Ω	4500MHz
LQG15HZ6N2S02□	LQG15HH6N2S02□	6.2nH ±0.3nH	100MHz	8	100MHz	600mA	0.2Ω	4500MHz
LQG15HZ6N8G02□	LQG15HH6N8G02□	6.8nH ±2%	100MHz	8	100MHz	600mA	0.22Ω	4500MHz
LQG15HZ6N8H02□	LQG15HH6N8H02□	6.8nH ±3%	100MHz	8	100MHz	600mA	0.22Ω	4500MHz
LQG15HZ6N8J02□	LQG15HH6N8J02□	6.8nH ±5%	100MHz	8	100MHz	600mA	0.22Ω	4500MHz
LQG15HZ7N5G02□	LQG15HH7N5G02□	7.5nH ±2%	100MHz	8	100MHz	550mA	0.24Ω	4200MHz
LQG15HZ7N5H02□	LQG15HH7N5H02□	7.5nH ±3%	100MHz	8	100MHz	550mA	0.24Ω	4200MHz
LQG15HZ7N5J02□	LQG15HH7N5J02□	7.5nH ±5%	100MHz	8	100MHz	550mA	0.24Ω	4200MHz
LQG15HZ8N2G02□	LQG15HH8N2G02□	8.2nH ±2%	100MHz	8	100MHz	550mA	0.24Ω	3700MHz
LQG15HZ8N2H02□	LQG15HH8N2H02□	8.2nH ±3%	100MHz	8	100MHz	550mA	0.24Ω	3700MHz
LQG15HZ8N2J02□	LQG15HH8N2J02□	8.2nH ±5%	100MHz	8	100MHz	550mA	0.24Ω	3700MHz
LQG15HZ9N1G02□	LQG15HH9N1G02□	9.1nH ±2%	100MHz	8	100MHz	500mA	0.26Ω	3400MHz
LQG15HZ9N1H02□	LQG15HH9N1H02□	9.1nH ±3%	100MHz	8	100MHz	500mA	0.26Ω	3400MHz
LQG15HZ9N1J02□	LQG15HH9N1J02□	9.1nH ±5%	100MHz	8	100MHz	500mA	0.26Ω	3400MHz
LQG15HZ10NG02□	LQG15HH10NG02□	10nH ±2%	100MHz	8	100MHz	500mA	0.26Ω	3400MHz
LQG15HZ10NH02□	LQG15HH10NH02□	10nH ±3%	100MHz	8	100MHz	500mA	0.26Ω	3400MHz
LQG15HZ10NJ02□	LQG15HH10NJ02□	10nH ±5%	100MHz	8	100MHz	500mA	0.26Ω	3400MHz
LQG15HZ12NG02□	LQG15HH12NG02□	12nH ±2%	100MHz	8	100MHz	500mA	0.28Ω	3000MHz
LQG15HZ12NH02□	LQG15HH12NH02□	12nH ±3%	100MHz	8	100MHz	500mA	0.28Ω	3000MHz
LQG15HZ12NJ02□	LQG15HH12NJ02□	12nH ±5%	100MHz	8	100MHz	500mA	0.28Ω	3000MHz
LQG15HZ15NG02□	LQG15HH15NG02□	15nH ±2%	100MHz	8	100MHz	450mA	0.32Ω	2500MHz
LQG15HZ15NH02□	LQG15HH15NH02□	15nH ±3%	100MHz	8	100MHz	450mA	0.32Ω	2500MHz
LQG15HZ15NJ02□	LQG15HH15NJ02□	15nH ±5%	100MHz	8	100MHz	450mA	0.32Ω	2500MHz

Operating temp.range (Self-temp.rise not included): -55 to 125°C

Only for reflow soldering

\*S.R.F: Self Resonant Frequency

Continued on the following page. ↗

Chip Ferrite Bead

Chip EMIFIL

Chip Common Mode Choke Coil

Block Type EMIFIL

Microchip Transformer (Ballun)

Inductors for Power Lines

Inductors for General Circuits

RF Inductors

Continued from the preceding page. ↘

Part Number		Inductance	Inductance Test Frequency	Q (min.)	Q Test Frequency	Rated Current	Max. of DC Resistance	S.R.F* (min.)
Infotainment	Powertrain/Safety							
LQG15HZ18NG02□	LQG15HH18NG02□	18nH ±2%	100MHz	8	100MHz	400mA	0.36Ω	2200MHz
LQG15HZ18NH02□	LQG15HH18NH02□	18nH ±3%	100MHz	8	100MHz	400mA	0.36Ω	2200MHz
LQG15HZ18NJ02□	LQG15HH18NJ02□	18nH ±5%	100MHz	8	100MHz	400mA	0.36Ω	2200MHz
LQG15HZ22NG02□	LQG15HH22NG02□	22nH ±2%	100MHz	8	100MHz	350mA	0.42Ω	1900MHz
LQG15HZ22NH02□	LQG15HH22NH02□	22nH ±3%	100MHz	8	100MHz	350mA	0.42Ω	1900MHz
LQG15HZ22NJ02□	LQG15HH22NJ02□	22nH ±5%	100MHz	8	100MHz	350mA	0.42Ω	1900MHz
LQG15HZ27NG02□	LQG15HH27NG02□	27nH ±2%	100MHz	8	100MHz	350mA	0.46Ω	1700MHz
LQG15HZ27NH02□	LQG15HH27NH02□	27nH ±3%	100MHz	8	100MHz	350mA	0.46Ω	1700MHz
LQG15HZ27NJ02□	LQG15HH27NJ02□	27nH ±5%	100MHz	8	100MHz	350mA	0.46Ω	1700MHz
LQG15HZ33NG02□	LQG15HH33NG02□	33nH ±2%	100MHz	8	100MHz	350mA	0.58Ω	1600MHz
LQG15HZ33NH02□	LQG15HH33NH02□	33nH ±3%	100MHz	8	100MHz	350mA	0.58Ω	1600MHz
LQG15HZ33NJ02□	LQG15HH33NJ02□	33nH ±5%	100MHz	8	100MHz	350mA	0.58Ω	1600MHz
LQG15HZ39NG02□	LQG15HH39NG02□	39nH ±2%	100MHz	8	100MHz	300mA	0.65Ω	1200MHz
LQG15HZ39NH02□	LQG15HH39NH02□	39nH ±3%	100MHz	8	100MHz	300mA	0.65Ω	1200MHz
LQG15HZ39NJ02□	LQG15HH39NJ02□	39nH ±5%	100MHz	8	100MHz	300mA	0.65Ω	1200MHz
LQG15HZ47NG02□	LQG15HH47NG02□	47nH ±2%	100MHz	8	100MHz	300mA	0.72Ω	1000MHz
LQG15HZ47NH02□	LQG15HH47NH02□	47nH ±3%	100MHz	8	100MHz	300mA	0.72Ω	1000MHz
LQG15HZ47NJ02□	LQG15HH47NJ02□	47nH ±5%	100MHz	8	100MHz	300mA	0.72Ω	1000MHz
LQG15HZ56NG02□	LQG15HH56NG02□	56nH ±2%	100MHz	8	100MHz	250mA	0.82Ω	800MHz
LQG15HZ56NH02□	LQG15HH56NH02□	56nH ±3%	100MHz	8	100MHz	250mA	0.82Ω	800MHz
LQG15HZ56NJ02□	LQG15HH56NJ02□	56nH ±5%	100MHz	8	100MHz	250mA	0.82Ω	800MHz
LQG15HZ68NG02□	LQG15HH68NG02□	68nH ±2%	100MHz	8	100MHz	250mA	0.92Ω	800MHz
LQG15HZ68NH02□	LQG15HH68NH02□	68nH ±3%	100MHz	8	100MHz	250mA	0.92Ω	800MHz
LQG15HZ68NJ02□	LQG15HH68NJ02□	68nH ±5%	100MHz	8	100MHz	250mA	0.92Ω	800MHz
LQG15HZ82NG02□	LQG15HH82NG02□	82nH ±2%	100MHz	8	100MHz	200mA	1.2Ω	700MHz
LQG15HZ82NH02□	LQG15HH82NH02□	82nH ±3%	100MHz	8	100MHz	200mA	1.2Ω	700MHz
LQG15HZ82NJ02□	LQG15HH82NJ02□	82nH ±5%	100MHz	8	100MHz	200mA	1.2Ω	700MHz
LQG15HZR10G02□	LQG15HHR10G02□	100nH ±2%	100MHz	8	100MHz	200mA	1.25Ω	600MHz
LQG15HZR10H02□	LQG15HHR10H02□	100nH ±3%	100MHz	8	100MHz	200mA	1.25Ω	600MHz
LQG15HZR10J02□	LQG15HHR10J02□	100nH ±5%	100MHz	8	100MHz	200mA	1.25Ω	600MHz
LQG15HZR12G02□	LQG15HHR12G02□	120nH ±2%	100MHz	8	100MHz	200mA	1.3Ω	600MHz
LQG15HZR12H02□	LQG15HHR12H02□	120nH ±3%	100MHz	8	100MHz	200mA	1.3Ω	600MHz
LQG15HZR12J02□	LQG15HHR12J02□	120nH ±5%	100MHz	8	100MHz	200mA	1.3Ω	600MHz
LQG15HZR15G02□	LQG15HHR15G02□	150nH ±2%	100MHz	8	100MHz	150mA	2.99Ω	550MHz
LQG15HZR15H02□	LQG15HHR15H02□	150nH ±3%	100MHz	8	100MHz	150mA	2.99Ω	550MHz
LQG15HZR15J02□	LQG15HHR15J02□	150nH ±5%	100MHz	8	100MHz	150mA	2.99Ω	550MHz
LQG15HZR18G02□	LQG15HHR18G02□	180nH ±2%	100MHz	8	100MHz	150mA	3.38Ω	500MHz
LQG15HZR18H02□	LQG15HHR18H02□	180nH ±3%	100MHz	8	100MHz	150mA	3.38Ω	500MHz
LQG15HZR18J02□	LQG15HHR18J02□	180nH ±5%	100MHz	8	100MHz	150mA	3.38Ω	500MHz
LQG15HZR22G02□	LQG15HHR22G02□	220nH ±2%	100MHz	8	100MHz	120mA	3.77Ω	450MHz
LQG15HZR22H02□	LQG15HHR22H02□	220nH ±3%	100MHz	8	100MHz	120mA	3.77Ω	450MHz
LQG15HZR22J02□	LQG15HHR22J02□	220nH ±5%	100MHz	8	100MHz	120mA	3.77Ω	450MHz
LQG15HZR27G02□	LQG15HHR27G02□	270nH ±2%	100MHz	8	100MHz	110mA	4.94Ω	400MHz
LQG15HZR27H02□	LQG15HHR27H02□	270nH ±3%	100MHz	8	100MHz	110mA	4.94Ω	400MHz
LQG15HZR27J02□	LQG15HHR27J02□	270nH ±5%	100MHz	8	100MHz	110mA	4.94Ω	400MHz

Operating temp.range (Self-temp.rise not included): -55 to 125°C

Only for reflow soldering

\*S.R.F: Self Resonant Frequency

Continued on the following page. ↗

Chip Ferrite Bead

Chip EMI/FIL

Chip Common Mode Choke Coil

Block Type EMI/FIL

Microchip Transformer (Balun)

Inductors for Power Lines

Inductors for General Circuits

RF Inductors

Continued from the preceding page. ↘

### Inductance-Frequency Characteristics (Typ.)

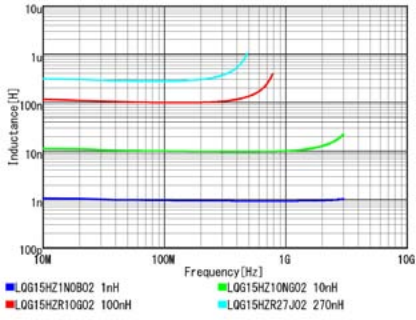

### Q-Frequency Characteristics (Typ.)

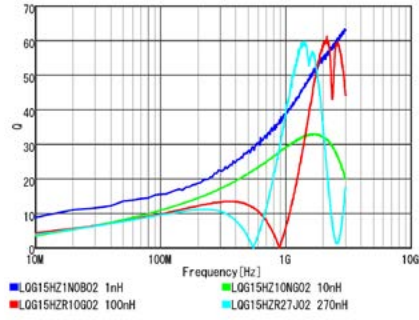

Chip Ferrite Bead

Chip EMIFIL

Chip Common Mode Choke Coil

Block Type EMIFIL

Microchip Transformer (Balun)

Inductors for Power Lines

Inductors for General Circuits

RF Inductors

# RF Inductors

## LQG15WZ\_02/LQG15WH\_02 Series 0402 (1005) inch (mm)

### Specifications Sheet (with cautions/mounting/packaging)

Infotainment	<a href="https://search.murata.co.jp/Ceramy/image/img/P02/JELF243B-9117.pdf">https://search.murata.co.jp/Ceramy/image/img/P02/JELF243B-9117.pdf</a>
Powertrain/Safety	<a href="https://search.murata.co.jp/Ceramy/image/img/P02/JELF243B-9118.pdf">https://search.murata.co.jp/Ceramy/image/img/P02/JELF243B-9118.pdf</a>

### Appearance/Dimensions

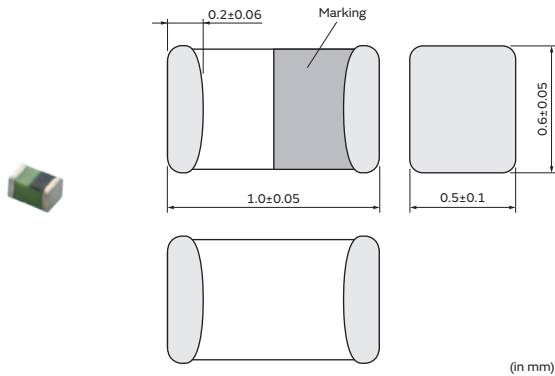

### Packaging

Code	Packaging	Minimum Quantity
D	ø180mm Paper Taping	10000
J	ø330mm Paper Taping	40000
B	Packing in Bulk	100

### Rated Value (□: packaging code)

Part Number		Inductance	Inductance Test Frequency	Q (min.)	Q Test Frequency	Rated Current	Max. of DC Resistance	S.R.F* (min.)
Infotainment	Powertrain/Safety							
LQG15WZ0N7B02□	LQG15WH0N7B02□	0.7nH ±0.1nH	100MHz	-	250MHz	1200mA	0.03Ω	15000MHz
LQG15WZ0N7C02□	LQG15WH0N7C02□	0.7nH ±0.2nH	100MHz	-	250MHz	1200mA	0.03Ω	15000MHz
LQG15WZ0N7S02□	LQG15WH0N7S02□	0.7nH ±0.3nH	100MHz	-	250MHz	1200mA	0.03Ω	15000MHz
LQG15WZ0N8B02□	LQG15WH0N8B02□	0.8nH ±0.1nH	100MHz	-	250MHz	1200mA	0.03Ω	15000MHz
LQG15WZ0N8C02□	LQG15WH0N8C02□	0.8nH ±0.2nH	100MHz	-	250MHz	1200mA	0.03Ω	15000MHz
LQG15WZ0N8S02□	LQG15WH0N8S02□	0.8nH ±0.3nH	100MHz	-	250MHz	1200mA	0.03Ω	15000MHz
LQG15WZ0N9B02□	LQG15WH0N9B02□	0.9nH ±0.1nH	100MHz	-	250MHz	1200mA	0.03Ω	15000MHz
LQG15WZ0N9C02□	LQG15WH0N9C02□	0.9nH ±0.2nH	100MHz	-	250MHz	1200mA	0.03Ω	15000MHz
LQG15WZ0N9S02□	LQG15WH0N9S02□	0.9nH ±0.3nH	100MHz	-	250MHz	1200mA	0.03Ω	15000MHz
LQG15WZ1N0B02□	LQG15WH1N0B02□	1nH ±0.1nH	100MHz	-	250MHz	1200mA	0.03Ω	15000MHz
LQG15WZ1N0C02□	LQG15WH1N0C02□	1nH ±0.2nH	100MHz	-	250MHz	1200mA	0.03Ω	15000MHz
LQG15WZ1N0S02□	LQG15WH1N0S02□	1nH ±0.3nH	100MHz	-	250MHz	1200mA	0.03Ω	15000MHz
LQG15WZ1N1B02□	LQG15WH1N1B02□	1.1nH ±0.1nH	100MHz	-	250MHz	1200mA	0.03Ω	14000MHz
LQG15WZ1N1C02□	LQG15WH1N1C02□	1.1nH ±0.2nH	100MHz	-	250MHz	1200mA	0.03Ω	14000MHz
LQG15WZ1N1S02□	LQG15WH1N1S02□	1.1nH ±0.3nH	100MHz	-	250MHz	1200mA	0.03Ω	14000MHz
LQG15WZ1N2B02□	LQG15WH1N2B02□	1.2nH ±0.1nH	100MHz	-	250MHz	1200mA	0.03Ω	13000MHz
LQG15WZ1N2C02□	LQG15WH1N2C02□	1.2nH ±0.2nH	100MHz	-	250MHz	1200mA	0.03Ω	13000MHz
LQG15WZ1N2S02□	LQG15WH1N2S02□	1.2nH ±0.3nH	100MHz	-	250MHz	1200mA	0.03Ω	13000MHz
LQG15WZ1N3B02□	LQG15WH1N3B02□	1.3nH ±0.1nH	100MHz	-	250MHz	1200mA	0.03Ω	12000MHz
LQG15WZ1N3C02□	LQG15WH1N3C02□	1.3nH ±0.2nH	100MHz	-	250MHz	1200mA	0.03Ω	12000MHz
LQG15WZ1N3S02□	LQG15WH1N3S02□	1.3nH ±0.3nH	100MHz	-	250MHz	1200mA	0.03Ω	12000MHz
LQG15WZ1N4B02□	LQG15WH1N4B02□	1.4nH ±0.1nH	100MHz	23	250MHz	1000mA	0.04Ω	12000MHz
LQG15WZ1N4C02□	LQG15WH1N4C02□	1.4nH ±0.2nH	100MHz	23	250MHz	1000mA	0.04Ω	12000MHz
LQG15WZ1N4S02□	LQG15WH1N4S02□	1.4nH ±0.3nH	100MHz	23	250MHz	1000mA	0.04Ω	12000MHz
LQG15WZ1N5B02□	LQG15WH1N5B02□	1.5nH ±0.1nH	100MHz	23	250MHz	1000mA	0.04Ω	11000MHz
LQG15WZ1N5C02□	LQG15WH1N5C02□	1.5nH ±0.2nH	100MHz	23	250MHz	1000mA	0.04Ω	11000MHz
LQG15WZ1N5S02□	LQG15WH1N5S02□	1.5nH ±0.3nH	100MHz	23	250MHz	1000mA	0.04Ω	11000MHz
LQG15WZ1N6B02□	LQG15WH1N6B02□	1.6nH ±0.1nH	100MHz	23	250MHz	1000mA	0.04Ω	10000MHz

Operating temp.range (Self-temp.rise not included): -55 to 125°C

Only for reflow soldering

\*S.R.F: Self Resonant Frequency

Continued on the following page. ↗



Continued from the preceding page. ↘

Part Number		Inductance	Inductance Test Frequency	Q (min.)	Q Test Frequency	Rated Current	Max. of DC Resistance	S.R.F.* (min.)
Infotainment	Powertrain/Safety							
LQG15WZ1N6C02□	LQG15WH1N6C02□	1.6nH ±0.2nH	100MHz	23	250MHz	1000mA	0.04Ω	10000MHz
LQG15WZ1N6S02□	LQG15WH1N6S02□	1.6nH ±0.3nH	100MHz	23	250MHz	1000mA	0.04Ω	10000MHz
LQG15WZ1N7B02□	LQG15WH1N7B02□	1.7nH ±0.1nH	100MHz	23	250MHz	1000mA	0.04Ω	10000MHz
LQG15WZ1N7C02□	LQG15WH1N7C02□	1.7nH ±0.2nH	100MHz	23	250MHz	1000mA	0.04Ω	10000MHz
LQG15WZ1N7S02□	LQG15WH1N7S02□	1.7nH ±0.3nH	100MHz	23	250MHz	1000mA	0.04Ω	10000MHz
LQG15WZ1N8B02□	LQG15WH1N8B02□	1.8nH ±0.1nH	100MHz	23	250MHz	1000mA	0.04Ω	9000MHz
LQG15WZ1N8C02□	LQG15WH1N8C02□	1.8nH ±0.2nH	100MHz	23	250MHz	1000mA	0.04Ω	9000MHz
LQG15WZ1N8S02□	LQG15WH1N8S02□	1.8nH ±0.3nH	100MHz	23	250MHz	1000mA	0.04Ω	9000MHz
LQG15WZ1N9B02□	LQG15WH1N9B02□	1.9nH ±0.1nH	100MHz	23	250MHz	1000mA	0.05Ω	8000MHz
LQG15WZ1N9C02□	LQG15WH1N9C02□	1.9nH ±0.2nH	100MHz	23	250MHz	1000mA	0.05Ω	8000MHz
LQG15WZ1N9S02□	LQG15WH1N9S02□	1.9nH ±0.3nH	100MHz	23	250MHz	1000mA	0.05Ω	8000MHz
LQG15WZ2N0B02□	LQG15WH2N0B02□	2nH ±0.1nH	100MHz	23	250MHz	1000mA	0.05Ω	8000MHz
LQG15WZ2N0C02□	LQG15WH2N0C02□	2nH ±0.2nH	100MHz	23	250MHz	1000mA	0.05Ω	8000MHz
LQG15WZ2N0S02□	LQG15WH2N0S02□	2nH ±0.3nH	100MHz	23	250MHz	1000mA	0.05Ω	8000MHz
LQG15WZ2N1B02□	LQG15WH2N1B02□	2.1nH ±0.1nH	100MHz	23	250MHz	1000mA	0.06Ω	8000MHz
LQG15WZ2N1C02□	LQG15WH2N1C02□	2.1nH ±0.2nH	100MHz	23	250MHz	1000mA	0.06Ω	8000MHz
LQG15WZ2N1S02□	LQG15WH2N1S02□	2.1nH ±0.3nH	100MHz	23	250MHz	1000mA	0.06Ω	8000MHz
LQG15WZ2N2B02□	LQG15WH2N2B02□	2.2nH ±0.1nH	100MHz	23	250MHz	1000mA	0.06Ω	8000MHz
LQG15WZ2N2C02□	LQG15WH2N2C02□	2.2nH ±0.2nH	100MHz	23	250MHz	1000mA	0.06Ω	8000MHz
LQG15WZ2N2S02□	LQG15WH2N2S02□	2.2nH ±0.3nH	100MHz	23	250MHz	1000mA	0.06Ω	8000MHz
LQG15WZ2N3B02□	LQG15WH2N3B02□	2.3nH ±0.1nH	100MHz	23	250MHz	1000mA	0.07Ω	7000MHz
LQG15WZ2N3C02□	LQG15WH2N3C02□	2.3nH ±0.2nH	100MHz	23	250MHz	1000mA	0.07Ω	7000MHz
LQG15WZ2N3S02□	LQG15WH2N3S02□	2.3nH ±0.3nH	100MHz	23	250MHz	1000mA	0.07Ω	7000MHz
LQG15WZ2N4B02□	LQG15WH2N4B02□	2.4nH ±0.1nH	100MHz	23	250MHz	1000mA	0.06Ω	6500MHz
LQG15WZ2N4C02□	LQG15WH2N4C02□	2.4nH ±0.2nH	100MHz	23	250MHz	1000mA	0.06Ω	6500MHz
LQG15WZ2N4S02□	LQG15WH2N4S02□	2.4nH ±0.3nH	100MHz	23	250MHz	1000mA	0.06Ω	6500MHz
LQG15WZ2N5B02□	LQG15WH2N5B02□	2.5nH ±0.1nH	100MHz	23	250MHz	900mA	0.07Ω	6500MHz
LQG15WZ2N5C02□	LQG15WH2N5C02□	2.5nH ±0.2nH	100MHz	23	250MHz	900mA	0.07Ω	6500MHz
LQG15WZ2N5S02□	LQG15WH2N5S02□	2.5nH ±0.3nH	100MHz	23	250MHz	900mA	0.07Ω	6500MHz
LQG15WZ2N6B02□	LQG15WH2N6B02□	2.6nH ±0.1nH	100MHz	23	250MHz	900mA	0.07Ω	6500MHz
LQG15WZ2N6C02□	LQG15WH2N6C02□	2.6nH ±0.2nH	100MHz	23	250MHz	900mA	0.07Ω	6500MHz
LQG15WZ2N6S02□	LQG15WH2N6S02□	2.6nH ±0.3nH	100MHz	23	250MHz	900mA	0.07Ω	6500MHz
LQG15WZ2N7B02□	LQG15WH2N7B02□	2.7nH ±0.1nH	100MHz	23	250MHz	900mA	0.07Ω	6500MHz
LQG15WZ2N7C02□	LQG15WH2N7C02□	2.7nH ±0.2nH	100MHz	23	250MHz	900mA	0.07Ω	6500MHz
LQG15WZ2N7S02□	LQG15WH2N7S02□	2.7nH ±0.3nH	100MHz	23	250MHz	900mA	0.07Ω	6500MHz
LQG15WZ2N8B02□	LQG15WH2N8B02□	2.8nH ±0.1nH	100MHz	23	250MHz	900mA	0.08Ω	6500MHz
LQG15WZ2N8C02□	LQG15WH2N8C02□	2.8nH ±0.2nH	100MHz	23	250MHz	900mA	0.08Ω	6500MHz
LQG15WZ2N8S02□	LQG15WH2N8S02□	2.8nH ±0.3nH	100MHz	23	250MHz	900mA	0.08Ω	6500MHz
LQG15WZ2N9B02□	LQG15WH2N9B02□	2.9nH ±0.1nH	100MHz	23	250MHz	900mA	0.08Ω	6500MHz
LQG15WZ2N9C02□	LQG15WH2N9C02□	2.9nH ±0.2nH	100MHz	23	250MHz	900mA	0.08Ω	6500MHz
LQG15WZ2N9S02□	LQG15WH2N9S02□	2.9nH ±0.3nH	100MHz	23	250MHz	900mA	0.08Ω	6500MHz
LQG15WZ3N0B02□	LQG15WH3N0B02□	3nH ±0.1nH	100MHz	23	250MHz	900mA	0.08Ω	6000MHz
LQG15WZ3N0C02□	LQG15WH3N0C02□	3nH ±0.2nH	100MHz	23	250MHz	900mA	0.08Ω	6000MHz
LQG15WZ3N0S02□	LQG15WH3N0S02□	3nH ±0.3nH	100MHz	23	250MHz	900mA	0.08Ω	6000MHz
LQG15WZ3N1B02□	LQG15WH3N1B02□	3.1nH ±0.1nH	100MHz	23	250MHz	900mA	0.09Ω	6000MHz
LQG15WZ3N1C02□	LQG15WH3N1C02□	3.1nH ±0.2nH	100MHz	23	250MHz	900mA	0.09Ω	6000MHz
LQG15WZ3N1S02□	LQG15WH3N1S02□	3.1nH ±0.3nH	100MHz	23	250MHz	900mA	0.09Ω	6000MHz
LQG15WZ3N2B02□	LQG15WH3N2B02□	3.2nH ±0.1nH	100MHz	23	250MHz	900mA	0.09Ω	6000MHz
LQG15WZ3N2C02□	LQG15WH3N2C02□	3.2nH ±0.2nH	100MHz	23	250MHz	900mA	0.09Ω	6000MHz
LQG15WZ3N2S02□	LQG15WH3N2S02□	3.2nH ±0.3nH	100MHz	23	250MHz	900mA	0.09Ω	6000MHz
LQG15WZ3N3B02□	LQG15WH3N3B02□	3.3nH ±0.1nH	100MHz	23	250MHz	900mA	0.08Ω	6000MHz
LQG15WZ3N3C02□	LQG15WH3N3C02□	3.3nH ±0.2nH	100MHz	23	250MHz	900mA	0.08Ω	6000MHz
LQG15WZ3N3S02□	LQG15WH3N3S02□	3.3nH ±0.3nH	100MHz	23	250MHz	900mA	0.08Ω	6000MHz

Operating temp.range (Self-temp.rise not included): -55 to 125°C  
 Only for reflow soldering  
 \*S.R.F.: Self Resonant Frequency

Continued on the following page. ↗



Continued from the preceding page. ↘

Part Number		Inductance	Inductance Test Frequency	Q (min.)	Q Test Frequency	Rated Current	Max. of DC Resistance	S.R.F.* (min.)
Infotainment	Powertrain/Safety							
LQG15WZ3N4B02□	LQG15WH3N4B02□	3.4nH ±0.1nH	100MHz	23	250MHz	900mA	0.09Ω	6000MHz
LQG15WZ3N4C02□	LQG15WH3N4C02□	3.4nH ±0.2nH	100MHz	23	250MHz	900mA	0.09Ω	6000MHz
LQG15WZ3N4S02□	LQG15WH3N4S02□	3.4nH ±0.3nH	100MHz	23	250MHz	900mA	0.09Ω	6000MHz
LQG15WZ3N5B02□	LQG15WH3N5B02□	3.5nH ±0.1nH	100MHz	23	250MHz	900mA	0.09Ω	5800MHz
LQG15WZ3N5C02□	LQG15WH3N5C02□	3.5nH ±0.2nH	100MHz	23	250MHz	900mA	0.09Ω	5800MHz
LQG15WZ3N5S02□	LQG15WH3N5S02□	3.5nH ±0.3nH	100MHz	23	250MHz	900mA	0.09Ω	5800MHz
LQG15WZ3N6B02□	LQG15WH3N6B02□	3.6nH ±0.1nH	100MHz	23	250MHz	900mA	0.09Ω	5500MHz
LQG15WZ3N6C02□	LQG15WH3N6C02□	3.6nH ±0.2nH	100MHz	23	250MHz	900mA	0.09Ω	5500MHz
LQG15WZ3N6S02□	LQG15WH3N6S02□	3.6nH ±0.3nH	100MHz	23	250MHz	900mA	0.09Ω	5500MHz
LQG15WZ3N7B02□	LQG15WH3N7B02□	3.7nH ±0.1nH	100MHz	23	250MHz	900mA	0.1Ω	5500MHz
LQG15WZ3N7C02□	LQG15WH3N7C02□	3.7nH ±0.2nH	100MHz	23	250MHz	900mA	0.1Ω	5500MHz
LQG15WZ3N7S02□	LQG15WH3N7S02□	3.7nH ±0.3nH	100MHz	23	250MHz	900mA	0.1Ω	5500MHz
LQG15WZ3N8B02□	LQG15WH3N8B02□	3.8nH ±0.1nH	100MHz	23	250MHz	900mA	0.1Ω	5000MHz
LQG15WZ3N8C02□	LQG15WH3N8C02□	3.8nH ±0.2nH	100MHz	23	250MHz	900mA	0.1Ω	5000MHz
LQG15WZ3N8S02□	LQG15WH3N8S02□	3.8nH ±0.3nH	100MHz	23	250MHz	900mA	0.1Ω	5000MHz
LQG15WZ3N9B02□	LQG15WH3N9B02□	3.9nH ±0.1nH	100MHz	23	250MHz	900mA	0.09Ω	5000MHz
LQG15WZ3N9C02□	LQG15WH3N9C02□	3.9nH ±0.2nH	100MHz	23	250MHz	900mA	0.09Ω	5000MHz
LQG15WZ3N9S02□	LQG15WH3N9S02□	3.9nH ±0.3nH	100MHz	23	250MHz	900mA	0.09Ω	5000MHz
LQG15WZ4N1B02□	LQG15WH4N1B02□	4.1nH ±0.1nH	100MHz	23	250MHz	800mA	0.1Ω	5000MHz
LQG15WZ4N1C02□	LQG15WH4N1C02□	4.1nH ±0.2nH	100MHz	23	250MHz	800mA	0.1Ω	5000MHz
LQG15WZ4N1S02□	LQG15WH4N1S02□	4.1nH ±0.3nH	100MHz	23	250MHz	800mA	0.1Ω	5000MHz
LQG15WZ4N3B02□	LQG15WH4N3B02□	4.3nH ±0.1nH	100MHz	23	250MHz	800mA	0.1Ω	5000MHz
LQG15WZ4N3C02□	LQG15WH4N3C02□	4.3nH ±0.2nH	100MHz	23	250MHz	800mA	0.1Ω	5000MHz
LQG15WZ4N3S02□	LQG15WH4N3S02□	4.3nH ±0.3nH	100MHz	23	250MHz	800mA	0.1Ω	5000MHz
LQG15WZ4N7B02□	LQG15WH4N7B02□	4.7nH ±0.1nH	100MHz	23	250MHz	800mA	0.11Ω	5000MHz
LQG15WZ4N7C02□	LQG15WH4N7C02□	4.7nH ±0.2nH	100MHz	23	250MHz	800mA	0.11Ω	5000MHz
LQG15WZ4N7S02□	LQG15WH4N7S02□	4.7nH ±0.3nH	100MHz	23	250MHz	800mA	0.11Ω	5000MHz
LQG15WZ5N1B02□	LQG15WH5N1B02□	5.1nH ±0.1nH	100MHz	23	250MHz	800mA	0.12Ω	4500MHz
LQG15WZ5N1C02□	LQG15WH5N1C02□	5.1nH ±0.2nH	100MHz	23	250MHz	800mA	0.12Ω	4500MHz
LQG15WZ5N1S02□	LQG15WH5N1S02□	5.1nH ±0.3nH	100MHz	23	250MHz	800mA	0.12Ω	4500MHz
LQG15WZ5N6B02□	LQG15WH5N6B02□	5.6nH ±0.1nH	100MHz	23	250MHz	800mA	0.13Ω	4500MHz
LQG15WZ5N6C02□	LQG15WH5N6C02□	5.6nH ±0.2nH	100MHz	23	250MHz	800mA	0.13Ω	4500MHz
LQG15WZ5N6S02□	LQG15WH5N6S02□	5.6nH ±0.3nH	100MHz	23	250MHz	800mA	0.13Ω	4500MHz
LQG15WZ5N8B02□	LQG15WH5N8B02□	5.8nH ±0.1nH	100MHz	23	250MHz	700mA	0.13Ω	4000MHz
LQG15WZ5N8C02□	LQG15WH5N8C02□	5.8nH ±0.2nH	100MHz	23	250MHz	700mA	0.13Ω	4000MHz
LQG15WZ5N8S02□	LQG15WH5N8S02□	5.8nH ±0.3nH	100MHz	23	250MHz	700mA	0.13Ω	4000MHz
LQG15WZ6N2B02□	LQG15WH6N2B02□	6.2nH ±0.1nH	100MHz	23	250MHz	700mA	0.13Ω	4000MHz
LQG15WZ6N2C02□	LQG15WH6N2C02□	6.2nH ±0.2nH	100MHz	23	250MHz	700mA	0.13Ω	4000MHz
LQG15WZ6N2S02□	LQG15WH6N2S02□	6.2nH ±0.3nH	100MHz	23	250MHz	700mA	0.13Ω	4000MHz
LQG15WZ6N8G02□	LQG15WH6N8G02□	6.8nH ±2%	100MHz	23	250MHz	700mA	0.14Ω	4000MHz
LQG15WZ6N8H02□	LQG15WH6N8H02□	6.8nH ±3%	100MHz	23	250MHz	700mA	0.14Ω	4000MHz
LQG15WZ6N8J02□	LQG15WH6N8J02□	6.8nH ±5%	100MHz	23	250MHz	700mA	0.14Ω	4000MHz
LQG15WZ7N3G02□	LQG15WH7N3G02□	7.3nH ±2%	100MHz	23	250MHz	600mA	0.17Ω	4000MHz
LQG15WZ7N3H02□	LQG15WH7N3H02□	7.3nH ±3%	100MHz	23	250MHz	600mA	0.17Ω	4000MHz
LQG15WZ7N3J02□	LQG15WH7N3J02□	7.3nH ±5%	100MHz	23	250MHz	600mA	0.17Ω	4000MHz
LQG15WZ7N5G02□	LQG15WH7N5G02□	7.5nH ±2%	100MHz	23	250MHz	600mA	0.16Ω	4000MHz
LQG15WZ7N5H02□	LQG15WH7N5H02□	7.5nH ±3%	100MHz	23	250MHz	600mA	0.16Ω	4000MHz
LQG15WZ7N5J02□	LQG15WH7N5J02□	7.5nH ±5%	100MHz	23	250MHz	600mA	0.16Ω	4000MHz
LQG15WZ8N2G02□	LQG15WH8N2G02□	8.2nH ±2%	100MHz	23	250MHz	550mA	0.16Ω	3600MHz
LQG15WZ8N2H02□	LQG15WH8N2H02□	8.2nH ±3%	100MHz	23	250MHz	550mA	0.16Ω	3600MHz
LQG15WZ8N2J02□	LQG15WH8N2J02□	8.2nH ±5%	100MHz	23	250MHz	550mA	0.16Ω	3600MHz
LQG15WZ8N7G02□	LQG15WH8N7G02□	8.7nH ±2%	100MHz	23	250MHz	550mA	0.17Ω	3500MHz
LQG15WZ8N7H02□	LQG15WH8N7H02□	8.7nH ±3%	100MHz	23	250MHz	550mA	0.17Ω	3500MHz

Operating temp.range (Self-temp.rise not included): -55 to 125°C

Only for reflow soldering

\*S.R.F.: Self Resonant Frequency

Continued on the following page. ↗

Continued from the preceding page. ↘

Part Number		Inductance	Inductance Test Frequency	Q (min.)	Q Test Frequency	Rated Current	Max. of DC Resistance	S.R.F* (min.)
Infotainment	Powertrain/Safety							
LQG15WZ8N7J02□	LQG15WH8N7J02□	8.7nH ±5%	100MHz	23	250MHz	550mA	0.17Ω	3500MHz
LQG15WZ9N1G02□	LQG15WH9N1G02□	9.1nH ±2%	100MHz	23	250MHz	550mA	0.17Ω	3400MHz
LQG15WZ9N1H02□	LQG15WH9N1H02□	9.1nH ±3%	100MHz	23	250MHz	550mA	0.17Ω	3400MHz
LQG15WZ9N1J02□	LQG15WH9N1J02□	9.1nH ±5%	100MHz	23	250MHz	550mA	0.17Ω	3400MHz
LQG15WZ9N5G02□	LQG15WH9N5G02□	9.5nH ±2%	100MHz	23	250MHz	500mA	0.21Ω	3300MHz
LQG15WZ9N5H02□	LQG15WH9N5H02□	9.5nH ±3%	100MHz	23	250MHz	500mA	0.21Ω	3300MHz
LQG15WZ9N5J02□	LQG15WH9N5J02□	9.5nH ±5%	100MHz	23	250MHz	500mA	0.21Ω	3300MHz
LQG15WZ10NG02□	LQG15WH10NG02□	10nH ±2%	100MHz	23	250MHz	500mA	0.19Ω	3300MHz
LQG15WZ10NH02□	LQG15WH10NH02□	10nH ±3%	100MHz	23	250MHz	500mA	0.19Ω	3300MHz
LQG15WZ10NJ02□	LQG15WH10NJ02□	10nH ±5%	100MHz	23	250MHz	500mA	0.19Ω	3300MHz
LQG15WZ11NG02□	LQG15WH11NG02□	11nH ±2%	100MHz	23	250MHz	450mA	0.22Ω	3000MHz
LQG15WZ11NH02□	LQG15WH11NH02□	11nH ±3%	100MHz	23	250MHz	450mA	0.22Ω	3000MHz
LQG15WZ11NJ02□	LQG15WH11NJ02□	11nH ±5%	100MHz	23	250MHz	450mA	0.22Ω	3000MHz
LQG15WZ12NG02□	LQG15WH12NG02□	12nH ±2%	100MHz	23	250MHz	450mA	0.24Ω	2800MHz
LQG15WZ12NH02□	LQG15WH12NH02□	12nH ±3%	100MHz	23	250MHz	450mA	0.24Ω	2800MHz
LQG15WZ12NJ02□	LQG15WH12NJ02□	12nH ±5%	100MHz	23	250MHz	450mA	0.24Ω	2800MHz
LQG15WZ13NG02□	LQG15WH13NG02□	13nH ±2%	100MHz	23	250MHz	400mA	0.26Ω	2800MHz
LQG15WZ13NH02□	LQG15WH13NH02□	13nH ±3%	100MHz	23	250MHz	400mA	0.26Ω	2800MHz
LQG15WZ13NJ02□	LQG15WH13NJ02□	13nH ±5%	100MHz	23	250MHz	400mA	0.26Ω	2800MHz
LQG15WZ15NG02□	LQG15WH15NG02□	15nH ±2%	100MHz	23	250MHz	400mA	0.28Ω	2300MHz
LQG15WZ15NH02□	LQG15WH15NH02□	15nH ±3%	100MHz	23	250MHz	400mA	0.28Ω	2300MHz
LQG15WZ15NJ02□	LQG15WH15NJ02□	15nH ±5%	100MHz	23	250MHz	400mA	0.28Ω	2300MHz
LQG15WZ16NG02□	LQG15WH16NG02□	16nH ±2%	100MHz	20	250MHz	260mA	0.8Ω	2300MHz
LQG15WZ16NH02□	LQG15WH16NH02□	16nH ±3%	100MHz	20	250MHz	260mA	0.8Ω	2300MHz
LQG15WZ16NJ02□	LQG15WH16NJ02□	16nH ±5%	100MHz	20	250MHz	260mA	0.8Ω	2300MHz
LQG15WZ18NG02□	LQG15WH18NG02□	18nH ±2%	100MHz	22	250MHz	260mA	0.8Ω	2300MHz
LQG15WZ18NH02□	LQG15WH18NH02□	18nH ±3%	100MHz	22	250MHz	260mA	0.8Ω	2300MHz
LQG15WZ18NJ02□	LQG15WH18NJ02□	18nH ±5%	100MHz	22	250MHz	260mA	0.8Ω	2300MHz
LQG15WZ19NG02□	LQG15WH19NG02□	19nH ±2%	100MHz	20	250MHz	260mA	0.8Ω	2300MHz
LQG15WZ19NH02□	LQG15WH19NH02□	19nH ±3%	100MHz	20	250MHz	260mA	0.8Ω	2300MHz
LQG15WZ19NJ02□	LQG15WH19NJ02□	19nH ±5%	100MHz	20	250MHz	260mA	0.8Ω	2300MHz
LQG15WZ20NG02□	LQG15WH20NG02□	20nH ±2%	100MHz	20	250MHz	260mA	1.1Ω	2100MHz
LQG15WZ20NH02□	LQG15WH20NH02□	20nH ±3%	100MHz	20	250MHz	260mA	1.1Ω	2100MHz
LQG15WZ20NJ02□	LQG15WH20NJ02□	20nH ±5%	100MHz	20	250MHz	260mA	1.1Ω	2100MHz
LQG15WZ22NG02□	LQG15WH22NG02□	22nH ±2%	100MHz	20	250MHz	230mA	1.1Ω	2100MHz
LQG15WZ22NH02□	LQG15WH22NH02□	22nH ±3%	100MHz	20	250MHz	230mA	1.1Ω	2100MHz
LQG15WZ22NJ02□	LQG15WH22NJ02□	22nH ±5%	100MHz	20	250MHz	230mA	1.1Ω	2100MHz
LQG15WZ23NG02□	LQG15WH23NG02□	23nH ±2%	100MHz	22	250MHz	230mA	1.1Ω	2000MHz
LQG15WZ23NH02□	LQG15WH23NH02□	23nH ±3%	100MHz	22	250MHz	230mA	1.1Ω	2000MHz
LQG15WZ23NJ02□	LQG15WH23NJ02□	23nH ±5%	100MHz	22	250MHz	230mA	1.1Ω	2000MHz
LQG15WZ24NG02□	LQG15WH24NG02□	24nH ±2%	100MHz	20	250MHz	230mA	1.2Ω	2000MHz
LQG15WZ24NH02□	LQG15WH24NH02□	24nH ±3%	100MHz	20	250MHz	230mA	1.2Ω	2000MHz
LQG15WZ24NJ02□	LQG15WH24NJ02□	24nH ±5%	100MHz	20	250MHz	230mA	1.2Ω	2000MHz
LQG15WZ27NG02□	LQG15WH27NG02□	27nH ±2%	100MHz	20	250MHz	230mA	1.3Ω	1700MHz
LQG15WZ27NH02□	LQG15WH27NH02□	27nH ±3%	100MHz	20	250MHz	230mA	1.3Ω	1700MHz
LQG15WZ27NJ02□	LQG15WH27NJ02□	27nH ±5%	100MHz	20	250MHz	230mA	1.3Ω	1700MHz
LQG15WZ30NG02□	LQG15WH30NG02□	30nH ±2%	100MHz	20	250MHz	220mA	1.3Ω	1700MHz
LQG15WZ30NH02□	LQG15WH30NH02□	30nH ±3%	100MHz	20	250MHz	220mA	1.3Ω	1700MHz
LQG15WZ30NJ02□	LQG15WH30NJ02□	30nH ±5%	100MHz	20	250MHz	220mA	1.3Ω	1700MHz
LQG15WZ33NG02□	LQG15WH33NG02□	33nH ±2%	100MHz	20	250MHz	220mA	1.5Ω	1600MHz
LQG15WZ33NH02□	LQG15WH33NH02□	33nH ±3%	100MHz	20	250MHz	220mA	1.5Ω	1600MHz
LQG15WZ33NJ02□	LQG15WH33NJ02□	33nH ±5%	100MHz	20	250MHz	220mA	1.5Ω	1600MHz
LQG15WZ36NG02□	LQG15WH36NG02□	36nH ±2%	100MHz	20	250MHz	190mA	1.5Ω	1600MHz

Operating temp.range (Self-temp.rise not included): -55 to 125°C

Only for reflow soldering

\*S.R.F: Self Resonant Frequency

Continued on the following page. ↗

Chip Ferrite Bead  
 Chip EMIFIL  
 Chip Common Mode Choke Coil  
 Block Type EMIFIL  
 Microchip Transformer (Ballun)  
 Inductors for Power Lines  
 Inductors for General Circuits  
 RF Inductors

Continued from the preceding page. ↘

Part Number		Inductance	Inductance Test Frequency	Q (min.)	Q Test Frequency	Rated Current	Max. of DC Resistance	S.R.F* (min.)
Infotainment	Powertrain/Safety							
LQG15WZ36NH02□	LQG15WH36NH02□	36nH ±3%	100MHz	20	250MHz	190mA	1.5Ω	1600MHz
LQG15WZ36NJ02□	LQG15WH36NJ02□	36nH ±5%	100MHz	20	250MHz	190mA	1.5Ω	1600MHz
LQG15WZ39NG02□	LQG15WH39NG02□	39nH ±2%	100MHz	20	250MHz	190mA	1.5Ω	1400MHz
LQG15WZ39NH02□	LQG15WH39NH02□	39nH ±3%	100MHz	20	250MHz	190mA	1.5Ω	1400MHz
LQG15WZ39NJ02□	LQG15WH39NJ02□	39nH ±5%	100MHz	20	250MHz	190mA	1.5Ω	1400MHz
LQG15WZ40NG02□	LQG15WH40NG02□	40nH ±2%	100MHz	20	250MHz	190mA	1.5Ω	1400MHz
LQG15WZ40NH02□	LQG15WH40NH02□	40nH ±3%	100MHz	20	250MHz	190mA	1.5Ω	1400MHz
LQG15WZ40NJ02□	LQG15WH40NJ02□	40nH ±5%	100MHz	20	250MHz	190mA	1.5Ω	1400MHz
LQG15WZ43NG02□	LQG15WH43NG02□	43nH ±2%	100MHz	22	250MHz	190mA	1.6Ω	1400MHz
LQG15WZ43NH02□	LQG15WH43NH02□	43nH ±3%	100MHz	22	250MHz	190mA	1.6Ω	1400MHz
LQG15WZ43NJ02□	LQG15WH43NJ02□	43nH ±5%	100MHz	22	250MHz	190mA	1.6Ω	1400MHz
LQG15WZ47NG02□	LQG15WH47NG02□	47nH ±2%	100MHz	22	250MHz	190mA	1.6Ω	1300MHz
LQG15WZ47NH02□	LQG15WH47NH02□	47nH ±3%	100MHz	22	250MHz	190mA	1.6Ω	1300MHz
LQG15WZ47NJ02□	LQG15WH47NJ02□	47nH ±5%	100MHz	22	250MHz	190mA	1.6Ω	1300MHz
LQG15WZ51NG02□	LQG15WH51NG02□	51nH ±2%	100MHz	22	250MHz	190mA	1.8Ω	1300MHz
LQG15WZ51NH02□	LQG15WH51NH02□	51nH ±3%	100MHz	22	250MHz	190mA	1.8Ω	1300MHz
LQG15WZ51NJ02□	LQG15WH51NJ02□	51nH ±5%	100MHz	22	250MHz	190mA	1.8Ω	1300MHz
LQG15WZ56NG02□	LQG15WH56NG02□	56nH ±2%	100MHz	22	250MHz	180mA	1.8Ω	1200MHz
LQG15WZ56NH02□	LQG15WH56NH02□	56nH ±3%	100MHz	22	250MHz	180mA	1.8Ω	1200MHz
LQG15WZ56NJ02□	LQG15WH56NJ02□	56nH ±5%	100MHz	22	250MHz	180mA	1.8Ω	1200MHz
LQG15WZ62NG02□	LQG15WH62NG02□	62nH ±2%	100MHz	22	250MHz	180mA	1.9Ω	1100MHz
LQG15WZ62NH02□	LQG15WH62NH02□	62nH ±3%	100MHz	22	250MHz	180mA	1.9Ω	1100MHz
LQG15WZ62NJ02□	LQG15WH62NJ02□	62nH ±5%	100MHz	22	250MHz	180mA	1.9Ω	1100MHz
LQG15WZ68NG02□	LQG15WH68NG02□	68nH ±2%	100MHz	22	250MHz	160mA	2Ω	1100MHz
LQG15WZ68NH02□	LQG15WH68NH02□	68nH ±3%	100MHz	22	250MHz	160mA	2Ω	1100MHz
LQG15WZ68NJ02□	LQG15WH68NJ02□	68nH ±5%	100MHz	22	250MHz	160mA	2Ω	1100MHz
LQG15WZ72NG02□	LQG15WH72NG02□	72nH ±2%	100MHz	22	250MHz	160mA	2.2Ω	1100MHz
LQG15WZ72NH02□	LQG15WH72NH02□	72nH ±3%	100MHz	22	250MHz	160mA	2.2Ω	1100MHz
LQG15WZ72NJ02□	LQG15WH72NJ02□	72nH ±5%	100MHz	22	250MHz	160mA	2.2Ω	1100MHz
LQG15WZ75NG02□	LQG15WH75NG02□	75nH ±2%	100MHz	22	250MHz	160mA	2.2Ω	1100MHz
LQG15WZ75NH02□	LQG15WH75NH02□	75nH ±3%	100MHz	22	250MHz	160mA	2.2Ω	1100MHz
LQG15WZ75NJ02□	LQG15WH75NJ02□	75nH ±5%	100MHz	22	250MHz	160mA	2.2Ω	1100MHz
LQG15WZ82NG02□	LQG15WH82NG02□	82nH ±2%	100MHz	22	250MHz	160mA	2.3Ω	900MHz
LQG15WZ82NH02□	LQG15WH82NH02□	82nH ±3%	100MHz	22	250MHz	160mA	2.3Ω	900MHz
LQG15WZ82NJ02□	LQG15WH82NJ02□	82nH ±5%	100MHz	22	250MHz	160mA	2.3Ω	900MHz
LQG15WZ91NG02□	LQG15WH91NG02□	91nH ±2%	100MHz	23	250MHz	160mA	2.3Ω	900MHz
LQG15WZ91NH02□	LQG15WH91NH02□	91nH ±3%	100MHz	23	250MHz	160mA	2.3Ω	900MHz
LQG15WZ91NJ02□	LQG15WH91NJ02□	91nH ±5%	100MHz	23	250MHz	160mA	2.3Ω	900MHz
LQG15WZR10G02□	LQG15WHR10G02□	100nH ±2%	100MHz	23	250MHz	150mA	2.5Ω	900MHz
LQG15WZR10H02□	LQG15WHR10H02□	100nH ±3%	100MHz	23	250MHz	150mA	2.5Ω	900MHz
LQG15WZR10J02□	LQG15WHR10J02□	100nH ±5%	100MHz	23	250MHz	150mA	2.5Ω	900MHz
LQG15WZR11G02□	LQG15WHR11G02□	110nH ±2%	100MHz	22	250MHz	150mA	2.7Ω	800MHz
LQG15WZR11H02□	LQG15WHR11H02□	110nH ±3%	100MHz	22	250MHz	150mA	2.7Ω	800MHz
LQG15WZR11J02□	LQG15WHR11J02□	110nH ±5%	100MHz	22	250MHz	150mA	2.7Ω	800MHz
LQG15WZR12G02□	LQG15WHR12G02□	120nH ±2%	100MHz	22	250MHz	140mA	2.7Ω	800MHz
LQG15WZR12H02□	LQG15WHR12H02□	120nH ±3%	100MHz	22	250MHz	140mA	2.7Ω	800MHz
LQG15WZR12J02□	LQG15WHR12J02□	120nH ±5%	100MHz	22	250MHz	140mA	2.7Ω	800MHz
LQG15WZR13G02□	LQG15WHR13G02□	130nH ±2%	100MHz	22	250MHz	110mA	2.9Ω	800MHz
LQG15WZR13H02□	LQG15WHR13H02□	130nH ±3%	100MHz	22	250MHz	110mA	2.9Ω	800MHz
LQG15WZR13J02□	LQG15WHR13J02□	130nH ±5%	100MHz	22	250MHz	110mA	2.9Ω	800MHz
LQG15WZR15G02□	LQG15WHR15G02□	150nH ±2%	100MHz	22	250MHz	110mA	3Ω	800MHz
LQG15WZR15H02□	LQG15WHR15H02□	150nH ±3%	100MHz	22	250MHz	110mA	3Ω	800MHz
LQG15WZR15J02□	LQG15WHR15J02□	150nH ±5%	100MHz	22	250MHz	110mA	3Ω	800MHz

Operating temp.range (Self-temp.rise not included): -55 to 125°C

Only for reflow soldering

\*S.R.F: Self Resonant Frequency

Continued on the following page. ↗

Continued from the preceding page. ↘

### Inductance-Frequency Characteristics (Typ.)

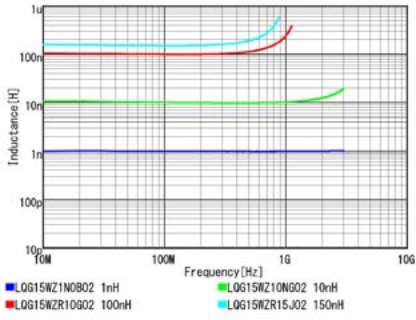

### Q-Frequency Characteristics (Typ.)

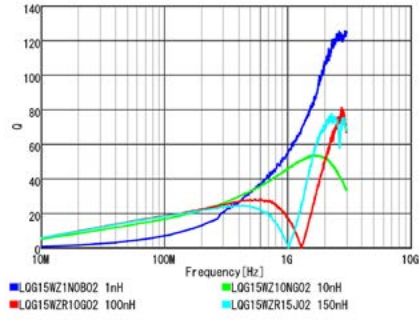

Chip Ferrite Bead

Chip EMIFIL

Chip Common Mode Choke Coil

Block Type EMIFIL

Microchip Transformer (Balun)

Inductors for Power Lines

Inductors for General Circuits

RF Inductors

**RF Inductors**

# LQG18HH\_00 Series 0603 (1608) inch (mm)

**Specifications Sheet (with cautions/mounting/packaging)**

Infotainment	—
Powertrain/Safety	<a href="https://search.murata.co.jp/Ceramy/image/img/P02/JELF243B-9102.pdf">https://search.murata.co.jp/Ceramy/image/img/P02/JELF243B-9102.pdf</a>

**Appearance/Dimensions**

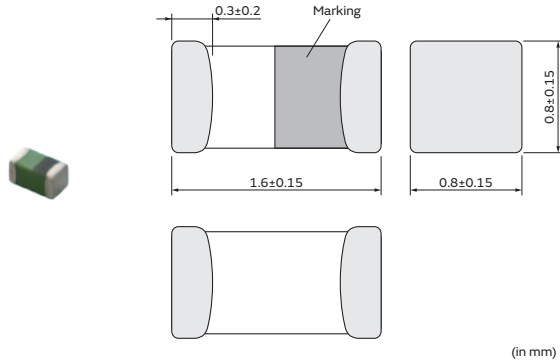

**Packaging**

Code	Packaging	Minimum Quantity
D	ø180mm Paper Taping	4000
J	ø330mm Paper Taping	10000
B	Packing in Bulk	1000

**Rated Value (□: packaging code)**

Part Number		Inductance	Inductance Test Frequency	Q (min.)	Q Test Frequency	Rated Current	Max. of DC Resistance	S.R.F.* (min.)
Infotainment	Powertrain/Safety							
—	LQG18HH1N2S00□	1.2nH ±0.3nH	100MHz	12	100MHz	1100mA	0.1Ω	6000MHz
—	LQG18HH1N5S00□	1.5nH ±0.3nH	100MHz	12	100MHz	1100mA	0.1Ω	6000MHz
—	LQG18HH1N8S00□	1.8nH ±0.3nH	100MHz	12	100MHz	1100mA	0.1Ω	5000MHz
—	LQG18HH2N2S00□	2.2nH ±0.3nH	100MHz	12	100MHz	1100mA	0.1Ω	5000MHz
—	LQG18HH2N7S00□	2.7nH ±0.3nH	100MHz	12	100MHz	1000mA	0.13Ω	4000MHz
—	LQG18HH3N3S00□	3.3nH ±0.3nH	100MHz	12	100MHz	900mA	0.14Ω	4000MHz
—	LQG18HH3N9S00□	3.9nH ±0.3nH	100MHz	12	100MHz	900mA	0.15Ω	3000MHz
—	LQG18HH4N7S00□	4.7nH ±0.3nH	100MHz	12	100MHz	800mA	0.16Ω	3000MHz
—	LQG18HH5N6S00□	5.6nH ±0.3nH	100MHz	12	100MHz	800mA	0.17Ω	3000MHz
—	LQG18HH6N2S00□	6.2nH ±0.3nH	100MHz	12	100MHz	800mA	0.18Ω	2800MHz
—	LQG18HH6N8J00□	6.8nH ±5%	100MHz	12	100MHz	800mA	0.18Ω	2800MHz
—	LQG18HH8N2J00□	8.2nH ±5%	100MHz	12	100MHz	800mA	0.2Ω	2600MHz
—	LQG18HH10NJ00□	10nH ±5%	100MHz	12	100MHz	700mA	0.25Ω	2400MHz
—	LQG18HH12NJ00□	12nH ±5%	100MHz	12	100MHz	600mA	0.3Ω	2200MHz
—	LQG18HH15NJ00□	15nH ±5%	100MHz	12	100MHz	600mA	0.35Ω	1800MHz
—	LQG18HH18NJ00□	18nH ±5%	100MHz	12	100MHz	600mA	0.35Ω	1800MHz
—	LQG18HH22NJ00□	22nH ±5%	100MHz	12	100MHz	500mA	0.5Ω	1600MHz
—	LQG18HH27NJ00□	27nH ±5%	100MHz	12	100MHz	500mA	0.54Ω	1400MHz
—	LQG18HH33NJ00□	33nH ±5%	100MHz	12	100MHz	500mA	0.54Ω	1200MHz
—	LQG18HH39NJ00□	39nH ±5%	100MHz	12	100MHz	400mA	0.6Ω	1000MHz
—	LQG18HH47NJ00□	47nH ±5%	100MHz	12	100MHz	400mA	0.7Ω	900MHz
—	LQG18HH56NJ00□	56nH ±5%	100MHz	12	100MHz	400mA	0.7Ω	800MHz
—	LQG18HH68NJ00□	68nH ±5%	100MHz	12	100MHz	400mA	0.8Ω	800MHz
—	LQG18HH82NJ00□	82nH ±5%	100MHz	12	100MHz	300mA	0.85Ω	700MHz
—	LQG18HHR10J00□	100nH ±5%	100MHz	12	100MHz	300mA	0.9Ω	600MHz
—	LQG18HHR12J00□	120nH ±5%	100MHz	14	100MHz	300mA	1.1Ω	550MHz
—	LQG18HHR15J00□	150nH ±5%	100MHz	14	100MHz	300mA	1.2Ω	550MHz
—	LQG18HHR18J00□	180nH ±5%	100MHz	14	100MHz	300mA	1.3Ω	500MHz

Operating temp.range (Self-temp.rise not included): -55 to 125°C

Only for reflow soldering

\*S.R.F.: Self Resonant Frequency

Continued on the following page. ↗

Continued from the preceding page. ↘

Part Number		Inductance	Inductance Test Frequency	Q (min.)	Q Test Frequency	Rated Current	Max. of DC Resistance	S.R.F.* (min.)
Infotainment	Powertrain/Safety							
—	LQG18HHR22J00□	220nH ±5%	100MHz	14	100MHz	300mA	1.5Ω	450MHz
—	LQG18HHR27J00□	270nH ±5%	100MHz	14	100MHz	200mA	1.9Ω	400MHz

Operating temp.range (Self-temp.rise not included): -55 to 125°C

Only for reflow soldering

\*S.R.F: Self Resonant Frequency

### Inductance-Frequency Characteristics (Typ.)

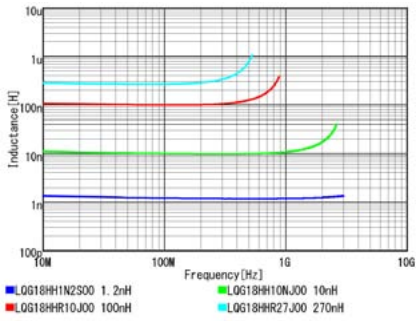

### Q-Frequency Characteristics (Typ.)

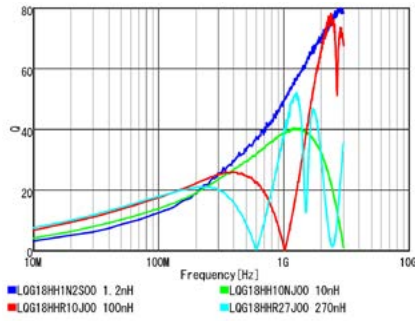



# RF Inductors

## LQP03TN\_Z2 Series 0201 (0603) inch (mm)

### Specifications Sheet (with cautions/mounting/packaging)

Infotainment	<a href="https://search.murata.co.jp/Ceramy/image/img/P02/JELF243C-9101.pdf">https://search.murata.co.jp/Ceramy/image/img/P02/JELF243C-9101.pdf</a>
Powertrain/Safety	—

### Appearance/Dimensions

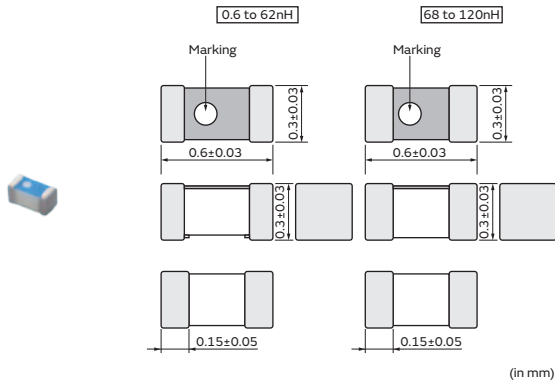

### Packaging

Code	Packaging	Minimum Quantity
D	ø180mm Paper Taping	15000
J	ø330mm Paper Taping	50000
B	Packing in Bulk	500

### Rated Value (□: packaging code)

Part Number		Inductance	Inductance Test Frequency	Q (min.)	Q Test Frequency	Rated Current	Max. of DC Resistance	S.R.F.* (min.)
Infotainment	Powertrain/Safety							
LQP03TN0N6BZ2□	—	0.6nH ±0.1nH	500MHz	14	500MHz	850mA	0.07Ω	20000MHz
LQP03TN0N6CZ2□	—	0.6nH ±0.2nH	500MHz	14	500MHz	850mA	0.07Ω	20000MHz
LQP03TN0N7BZ2□	—	0.7nH ±0.1nH	500MHz	14	500MHz	800mA	0.08Ω	20000MHz
LQP03TN0N7CZ2□	—	0.7nH ±0.2nH	500MHz	14	500MHz	800mA	0.08Ω	20000MHz
LQP03TN0N8BZ2□	—	0.8nH ±0.1nH	500MHz	14	500MHz	800mA	0.08Ω	18000MHz
LQP03TN0N8CZ2□	—	0.8nH ±0.2nH	500MHz	14	500MHz	800mA	0.08Ω	18000MHz
LQP03TN0N9BZ2□	—	0.9nH ±0.1nH	500MHz	14	500MHz	750mA	0.1Ω	18000MHz
LQP03TN0N9CZ2□	—	0.9nH ±0.2nH	500MHz	14	500MHz	750mA	0.1Ω	18000MHz
LQP03TN1N0BZ2□	—	1nH ±0.1nH	500MHz	14	500MHz	750mA	0.1Ω	17000MHz
LQP03TN1N0CZ2□	—	1nH ±0.2nH	500MHz	14	500MHz	750mA	0.1Ω	17000MHz
LQP03TN1N1BZ2□	—	1.1nH ±0.1nH	500MHz	14	500MHz	750mA	0.1Ω	17000MHz
LQP03TN1N1CZ2□	—	1.1nH ±0.2nH	500MHz	14	500MHz	750mA	0.1Ω	17000MHz
LQP03TN1N2BZ2□	—	1.2nH ±0.1nH	500MHz	14	500MHz	750mA	0.1Ω	17000MHz
LQP03TN1N2CZ2□	—	1.2nH ±0.2nH	500MHz	14	500MHz	750mA	0.1Ω	17000MHz
LQP03TN1N3BZ2□	—	1.3nH ±0.1nH	500MHz	14	500MHz	600mA	0.15Ω	17000MHz
LQP03TN1N3CZ2□	—	1.3nH ±0.2nH	500MHz	14	500MHz	600mA	0.15Ω	17000MHz
LQP03TN1N4BZ2□	—	1.4nH ±0.1nH	500MHz	14	500MHz	600mA	0.15Ω	16000MHz
LQP03TN1N4CZ2□	—	1.4nH ±0.2nH	500MHz	14	500MHz	600mA	0.15Ω	16000MHz
LQP03TN1N5BZ2□	—	1.5nH ±0.1nH	500MHz	14	500MHz	600mA	0.15Ω	15000MHz
LQP03TN1N5CZ2□	—	1.5nH ±0.2nH	500MHz	14	500MHz	600mA	0.15Ω	15000MHz
LQP03TN1N6BZ2□	—	1.6nH ±0.1nH	500MHz	14	500MHz	600mA	0.15Ω	15000MHz
LQP03TN1N6CZ2□	—	1.6nH ±0.2nH	500MHz	14	500MHz	600mA	0.15Ω	15000MHz
LQP03TN1N7BZ2□	—	1.7nH ±0.1nH	500MHz	14	500MHz	600mA	0.15Ω	15000MHz
LQP03TN1N7CZ2□	—	1.7nH ±0.2nH	500MHz	14	500MHz	600mA	0.15Ω	15000MHz
LQP03TN1N8BZ2□	—	1.8nH ±0.1nH	500MHz	14	500MHz	600mA	0.15Ω	15000MHz
LQP03TN1N8CZ2□	—	1.8nH ±0.2nH	500MHz	14	500MHz	600mA	0.15Ω	15000MHz
LQP03TN1N9BZ2□	—	1.9nH ±0.1nH	500MHz	14	500MHz	600mA	0.15Ω	12500MHz
LQP03TN1N9CZ2□	—	1.9nH ±0.2nH	500MHz	14	500MHz	600mA	0.15Ω	12500MHz

Operating temp.range (Self-temp.rise not included): -55 to 125°C

Only for reflow soldering

\*S.R.F.: Self Resonant Frequency

Continued on the following page. ↗

Continued from the preceding page. ↘

Part Number		Inductance	Inductance Test Frequency	Q (min.)	Q Test Frequency	Rated Current	Max. of DC Resistance	S.R.F.* (min.)
Infotainment	Powertrain/Safety							
LQP03TN2N0BZ2□	—	2nH ±0.1nH	500MHz	14	500MHz	600mA	0.15Ω	12500MHz
LQP03TN2N0CZ2□	—	2nH ±0.2nH	500MHz	14	500MHz	600mA	0.15Ω	12500MHz
LQP03TN2N1BZ2□	—	2.1nH ±0.1nH	500MHz	14	500MHz	600mA	0.15Ω	11000MHz
LQP03TN2N1CZ2□	—	2.1nH ±0.2nH	500MHz	14	500MHz	600mA	0.15Ω	11000MHz
LQP03TN2N2BZ2□	—	2.2nH ±0.1nH	500MHz	14	500MHz	600mA	0.15Ω	11000MHz
LQP03TN2N2CZ2□	—	2.2nH ±0.2nH	500MHz	14	500MHz	600mA	0.15Ω	11000MHz
LQP03TN2N3BZ2□	—	2.3nH ±0.1nH	500MHz	14	500MHz	500mA	0.2Ω	10000MHz
LQP03TN2N3CZ2□	—	2.3nH ±0.2nH	500MHz	14	500MHz	500mA	0.2Ω	10000MHz
LQP03TN2N4BZ2□	—	2.4nH ±0.1nH	500MHz	14	500MHz	500mA	0.2Ω	10000MHz
LQP03TN2N4CZ2□	—	2.4nH ±0.2nH	500MHz	14	500MHz	500mA	0.2Ω	10000MHz
LQP03TN2N5BZ2□	—	2.5nH ±0.1nH	500MHz	14	500MHz	500mA	0.2Ω	10000MHz
LQP03TN2N5CZ2□	—	2.5nH ±0.2nH	500MHz	14	500MHz	500mA	0.2Ω	10000MHz
LQP03TN2N6BZ2□	—	2.6nH ±0.1nH	500MHz	14	500MHz	500mA	0.2Ω	10000MHz
LQP03TN2N6CZ2□	—	2.6nH ±0.2nH	500MHz	14	500MHz	500mA	0.2Ω	10000MHz
LQP03TN2N7BZ2□	—	2.7nH ±0.1nH	500MHz	14	500MHz	500mA	0.2Ω	10000MHz
LQP03TN2N7CZ2□	—	2.7nH ±0.2nH	500MHz	14	500MHz	500mA	0.2Ω	10000MHz
LQP03TN2N8BZ2□	—	2.8nH ±0.1nH	500MHz	14	500MHz	500mA	0.2Ω	9500MHz
LQP03TN2N8CZ2□	—	2.8nH ±0.2nH	500MHz	14	500MHz	500mA	0.2Ω	9500MHz
LQP03TN2N9BZ2□	—	2.9nH ±0.1nH	500MHz	14	500MHz	500mA	0.2Ω	9500MHz
LQP03TN2N9CZ2□	—	2.9nH ±0.2nH	500MHz	14	500MHz	500mA	0.2Ω	9500MHz
LQP03TN3N0BZ2□	—	3nH ±0.1nH	500MHz	14	500MHz	450mA	0.25Ω	9500MHz
LQP03TN3N0CZ2□	—	3nH ±0.2nH	500MHz	14	500MHz	450mA	0.25Ω	9500MHz
LQP03TN3N1BZ2□	—	3.1nH ±0.1nH	500MHz	14	500MHz	450mA	0.25Ω	8000MHz
LQP03TN3N1CZ2□	—	3.1nH ±0.2nH	500MHz	14	500MHz	450mA	0.25Ω	8000MHz
LQP03TN3N2BZ2□	—	3.2nH ±0.1nH	500MHz	14	500MHz	450mA	0.25Ω	8000MHz
LQP03TN3N2CZ2□	—	3.2nH ±0.2nH	500MHz	14	500MHz	450mA	0.25Ω	8000MHz
LQP03TN3N3BZ2□	—	3.3nH ±0.1nH	500MHz	14	500MHz	450mA	0.25Ω	8000MHz
LQP03TN3N3CZ2□	—	3.3nH ±0.2nH	500MHz	14	500MHz	450mA	0.25Ω	8000MHz
LQP03TN3N4BZ2□	—	3.4nH ±0.1nH	500MHz	14	500MHz	450mA	0.25Ω	7000MHz
LQP03TN3N4CZ2□	—	3.4nH ±0.2nH	500MHz	14	500MHz	450mA	0.25Ω	7000MHz
LQP03TN3N5BZ2□	—	3.5nH ±0.1nH	500MHz	14	500MHz	450mA	0.25Ω	7000MHz
LQP03TN3N5CZ2□	—	3.5nH ±0.2nH	500MHz	14	500MHz	450mA	0.25Ω	7000MHz
LQP03TN3N6BZ2□	—	3.6nH ±0.1nH	500MHz	14	500MHz	400mA	0.3Ω	6000MHz
LQP03TN3N6CZ2□	—	3.6nH ±0.2nH	500MHz	14	500MHz	400mA	0.3Ω	6000MHz
LQP03TN3N7BZ2□	—	3.7nH ±0.1nH	500MHz	14	500MHz	400mA	0.3Ω	6000MHz
LQP03TN3N7CZ2□	—	3.7nH ±0.2nH	500MHz	14	500MHz	400mA	0.3Ω	6000MHz
LQP03TN3N8BZ2□	—	3.8nH ±0.1nH	500MHz	14	500MHz	400mA	0.3Ω	6000MHz
LQP03TN3N8CZ2□	—	3.8nH ±0.2nH	500MHz	14	500MHz	400mA	0.3Ω	6000MHz
LQP03TN3N9BZ2□	—	3.9nH ±0.1nH	500MHz	14	500MHz	400mA	0.3Ω	5700MHz
LQP03TN3N9CZ2□	—	3.9nH ±0.2nH	500MHz	14	500MHz	400mA	0.3Ω	5700MHz
LQP03TN4N0BZ2□	—	4nH ±0.1nH	500MHz	14	500MHz	350mA	0.4Ω	5300MHz
LQP03TN4N0CZ2□	—	4nH ±0.2nH	500MHz	14	500MHz	350mA	0.4Ω	5300MHz
LQP03TN4N1BZ2□	—	4.1nH ±0.1nH	500MHz	14	500MHz	350mA	0.4Ω	5300MHz
LQP03TN4N1CZ2□	—	4.1nH ±0.2nH	500MHz	14	500MHz	350mA	0.4Ω	5300MHz
LQP03TN4N2BZ2□	—	4.2nH ±0.1nH	500MHz	14	500MHz	350mA	0.4Ω	5300MHz
LQP03TN4N2CZ2□	—	4.2nH ±0.2nH	500MHz	14	500MHz	350mA	0.4Ω	5300MHz
LQP03TN4N3HZ2□	—	4.3nH ±3%	500MHz	14	500MHz	350mA	0.4Ω	5300MHz
LQP03TN4N3JZ2□	—	4.3nH ±5%	500MHz	14	500MHz	350mA	0.4Ω	5300MHz
LQP03TN4N7HZ2□	—	4.7nH ±3%	500MHz	14	500MHz	350mA	0.4Ω	4400MHz
LQP03TN4N7JZ2□	—	4.7nH ±5%	500MHz	14	500MHz	350mA	0.4Ω	4400MHz
LQP03TN5N1HZ2□	—	5.1nH ±3%	500MHz	14	500MHz	350mA	0.4Ω	4200MHz
LQP03TN5N1JZ2□	—	5.1nH ±5%	500MHz	14	500MHz	350mA	0.4Ω	4200MHz
LQP03TN5N6HZ2□	—	5.6nH ±3%	500MHz	14	500MHz	350mA	0.4Ω	4000MHz

Operating temp.range (Self-temp.rise not included): -55 to 125°C

Only for reflow soldering

\*S.R.F.: Self Resonant Frequency

Chip Ferrite Bead

Chip EMIFIL

Chip Common Mode Choke Coil

Block Type EMIFIL

Microchip Transformer (Ballun)

Inductors for Power Lines

Inductors for General Circuits

RF Inductors



Continued from the preceding page. ↘

Part Number		Inductance	Inductance Test Frequency	Q (min.)	Q Test Frequency	Rated Current	Max. of DC Resistance	S.R.F.* (min.)
Infotainment	Powertrain/Safety							
LQP03TN5N6JZ2□	—	5.6nH ±5%	500MHz	14	500MHz	350mA	0.4Ω	4000MHz
LQP03TN6N2HZ2□	—	6.2nH ±3%	500MHz	14	500MHz	300mA	0.6Ω	4000MHz
LQP03TN6N2JZ2□	—	6.2nH ±5%	500MHz	14	500MHz	300mA	0.6Ω	4000MHz
LQP03TN6N8HZ2□	—	6.8nH ±3%	500MHz	14	500MHz	300mA	0.6Ω	3900MHz
LQP03TN6N8JZ2□	—	6.8nH ±5%	500MHz	14	500MHz	300mA	0.6Ω	3900MHz
LQP03TN7N5HZ2□	—	7.5nH ±3%	500MHz	14	500MHz	300mA	0.6Ω	3700MHz
LQP03TN7N5JZ2□	—	7.5nH ±5%	500MHz	14	500MHz	300mA	0.6Ω	3700MHz
LQP03TN8N2HZ2□	—	8.2nH ±3%	500MHz	14	500MHz	250mA	0.7Ω	3600MHz
LQP03TN8N2JZ2□	—	8.2nH ±5%	500MHz	14	500MHz	250mA	0.7Ω	3600MHz
LQP03TN9N1HZ2□	—	9.1nH ±3%	500MHz	14	500MHz	250mA	0.7Ω	3300MHz
LQP03TN9N1JZ2□	—	9.1nH ±5%	500MHz	14	500MHz	250mA	0.7Ω	3300MHz
LQP03TN10NHZ2□	—	10nH ±3%	500MHz	14	500MHz	250mA	0.7Ω	3200MHz
LQP03TN10NJZ2□	—	10nH ±5%	500MHz	14	500MHz	250mA	0.7Ω	3200MHz
LQP03TN11NHZ2□	—	11nH ±3%	500MHz	14	500MHz	250mA	0.8Ω	2900MHz
LQP03TN11NJZ2□	—	11nH ±5%	500MHz	14	500MHz	250mA	0.8Ω	2900MHz
LQP03TN12NHZ2□	—	12nH ±3%	500MHz	12	500MHz	250mA	0.7Ω	2900MHz
LQP03TN12NJZ2□	—	12nH ±5%	500MHz	12	500MHz	250mA	0.7Ω	2900MHz
LQP03TN13NHZ2□	—	13nH ±3%	500MHz	12	500MHz	250mA	0.8Ω	2600MHz
LQP03TN13NJZ2□	—	13nH ±5%	500MHz	12	500MHz	250mA	0.8Ω	2600MHz
LQP03TN15NHZ2□	—	15nH ±3%	500MHz	12	500MHz	250mA	0.7Ω	2600MHz
LQP03TN15NJZ2□	—	15nH ±5%	500MHz	12	500MHz	250mA	0.7Ω	2600MHz
LQP03TN16NHZ2□	—	16nH ±3%	500MHz	12	500MHz	200mA	0.95Ω	2200MHz
LQP03TN16NJZ2□	—	16nH ±5%	500MHz	12	500MHz	200mA	0.95Ω	2200MHz
LQP03TN18NHZ2□	—	18nH ±3%	500MHz	12	500MHz	200mA	0.8Ω	2200MHz
LQP03TN18NJZ2□	—	18nH ±5%	500MHz	12	500MHz	200mA	0.8Ω	2200MHz
LQP03TN20NHZ2□	—	20nH ±3%	500MHz	12	500MHz	150mA	2.3Ω	2200MHz
LQP03TN20NJZ2□	—	20nH ±5%	500MHz	12	500MHz	150mA	2.3Ω	2200MHz
LQP03TN22NHZ2□	—	22nH ±3%	500MHz	12	500MHz	150mA	1.9Ω	2200MHz
LQP03TN22NJZ2□	—	22nH ±5%	500MHz	12	500MHz	150mA	1.9Ω	2200MHz
LQP03TN24NHZ2□	—	24nH ±3%	500MHz	12	500MHz	140mA	2.3Ω	2000MHz
LQP03TN24NJZ2□	—	24nH ±5%	500MHz	12	500MHz	140mA	2.3Ω	2000MHz
LQP03TN27NHZ2□	—	27nH ±3%	500MHz	12	500MHz	140mA	2.3Ω	2000MHz
LQP03TN27NJZ2□	—	27nH ±5%	500MHz	12	500MHz	140mA	2.3Ω	2000MHz
LQP03TN30NHZ2□	—	30nH ±3%	500MHz	9	500MHz	120mA	2.95Ω	1700MHz
LQP03TN30NJZ2□	—	30nH ±5%	500MHz	9	500MHz	120mA	2.95Ω	1700MHz
LQP03TN33NHZ2□	—	33nH ±3%	300MHz	9	300MHz	120mA	2.95Ω	1700MHz
LQP03TN33NJZ2□	—	33nH ±5%	300MHz	9	300MHz	120mA	2.95Ω	1700MHz
LQP03TN36NHZ2□	—	36nH ±3%	300MHz	9	300MHz	120mA	3Ω	1500MHz
LQP03TN36NJZ2□	—	36nH ±5%	300MHz	9	300MHz	120mA	3Ω	1500MHz
LQP03TN39NHZ2□	—	39nH ±3%	300MHz	9	300MHz	120mA	3Ω	1500MHz
LQP03TN39NJZ2□	—	39nH ±5%	300MHz	9	300MHz	120mA	3Ω	1500MHz
LQP03TN43NHZ2□	—	43nH ±3%	300MHz	9	300MHz	100mA	3.6Ω	1300MHz
LQP03TN43NJZ2□	—	43nH ±5%	300MHz	9	300MHz	100mA	3.6Ω	1300MHz
LQP03TN47NHZ2□	—	47nH ±3%	300MHz	9	300MHz	100mA	3.6Ω	1300MHz
LQP03TN47NJZ2□	—	47nH ±5%	300MHz	9	300MHz	100mA	3.6Ω	1300MHz
LQP03TN51NHZ2□	—	51nH ±3%	300MHz	9	300MHz	100mA	3.9Ω	1200MHz
LQP03TN51NJZ2□	—	51nH ±5%	300MHz	9	300MHz	100mA	3.9Ω	1200MHz
LQP03TN56NHZ2□	—	56nH ±3%	300MHz	9	300MHz	100mA	3.9Ω	1200MHz
LQP03TN56NJZ2□	—	56nH ±5%	300MHz	9	300MHz	100mA	3.9Ω	1200MHz
LQP03TN62NHZ2□	—	62nH ±3%	300MHz	8	300MHz	100mA	8Ω	1100MHz
LQP03TN62NJZ2□	—	62nH ±5%	300MHz	8	300MHz	100mA	8Ω	1100MHz
LQP03TN68NHZ2□	—	68nH ±3%	300MHz	8	300MHz	100mA	8Ω	1100MHz
LQP03TN68NJZ2□	—	68nH ±5%	300MHz	8	300MHz	100mA	8Ω	1100MHz

Operating temp.range (Self-temp.rise not included): -55 to 125°C

Only for reflow soldering

\*S.R.F.: Self Resonant Frequency

Continued on the following page. ↗

Continued from the preceding page. ↘

Part Number		Inductance	Inductance Test Frequency	Q (min.)	Q Test Frequency	Rated Current	Max. of DC Resistance	S.R.F.* (min.)
Infotainment	Powertrain/Safety							
LQP03TN75NHZ2□	—	75nH ±3%	300MHz	8	300MHz	100mA	10Ω	1000MHz
LQP03TN75NJZ2□	—	75nH ±5%	300MHz	8	300MHz	100mA	10Ω	1000MHz
LQP03TN82NHZ2□	—	82nH ±3%	300MHz	8	300MHz	100mA	10Ω	1000MHz
LQP03TN82NJZ2□	—	82nH ±5%	300MHz	8	300MHz	100mA	10Ω	1000MHz
LQP03TN91NHZ2□	—	91nH ±3%	300MHz	8	300MHz	80mA	10Ω	900MHz
LQP03TN91NJZ2□	—	91nH ±5%	300MHz	8	300MHz	80mA	10Ω	900MHz
LQP03TNR10HZ2□	—	100nH ±3%	300MHz	8	300MHz	80mA	10Ω	900MHz
LQP03TNR10JZ2□	—	100nH ±5%	300MHz	8	300MHz	80mA	10Ω	900MHz
LQP03TNR11HZ2□	—	110nH ±3%	300MHz	8	300MHz	80mA	12Ω	800MHz
LQP03TNR11JZ2□	—	110nH ±5%	300MHz	8	300MHz	80mA	12Ω	800MHz
LQP03TNR12HZ2□	—	120nH ±3%	300MHz	8	300MHz	80mA	12Ω	800MHz
LQP03TNR12JZ2□	—	120nH ±5%	300MHz	8	300MHz	80mA	12Ω	800MHz

Operating temp.range (Self-temp.rise not included): -55 to 125°C

Only for reflow soldering

\*S.R.F.: Self Resonant Frequency

### Inductance-Frequency Characteristics (Typ.)

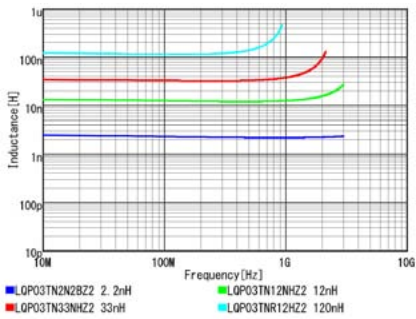

### Q-Frequency Characteristics (Typ.)

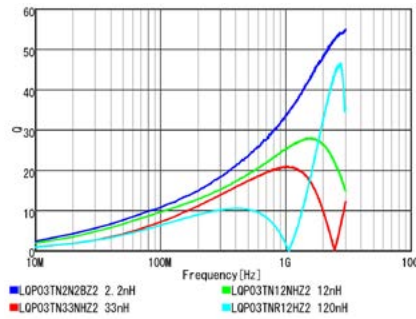

Chip Ferrite Bead

Chip EMIFIL

Chip Common Mode Choke Coil

Block Type EMIFIL

Microchip Transformer (Balun)

Inductors for Power Lines

Inductors for General Circuits

RF Inductors

# RF Inductors

## LQW15AN\_0Z Series 0402 (1005) inch (mm)

### Specifications Sheet (with cautions/mounting/packaging)

Infotainment	<a href="https://search.murata.co.jp/Ceramy/image/img/P02/JELF243A-9114.pdf">https://search.murata.co.jp/Ceramy/image/img/P02/JELF243A-9114.pdf</a>
Powertrain/Safety	—

### Appearance/Dimensions

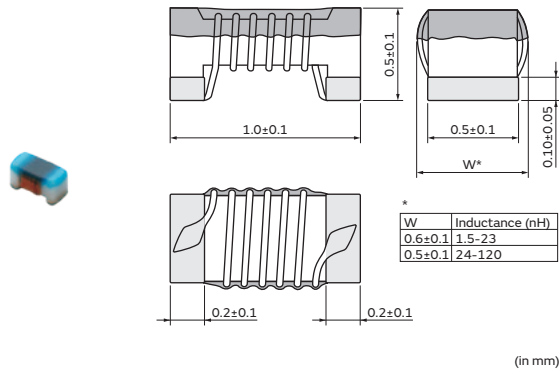

### Packaging

Code	Packaging	Minimum Quantity
D	ø180mm Paper Taping	10000
B	Packing in Bulk	500

### Rated Value (□: packaging code)

Part Number		Inductance	Inductance Test Frequency	Q (min.)	Q Test Frequency	Rated Current	Max. of DC Resistance	S.R.F* (min.)
Infotainment	Powertrain/Safety							
LQW15AN1N5B0Z□	—	1.5nH ±0.1nH	100MHz	10	250MHz	1000mA	0.03Ω	18GHz
LQW15AN1N5C0Z□	—	1.5nH ±0.2nH	100MHz	10	250MHz	1000mA	0.03Ω	18GHz
LQW15AN1N5D0Z□	—	1.5nH ±0.5nH	100MHz	10	250MHz	1000mA	0.03Ω	18GHz
LQW15AN1N6C0Z□	—	1.6nH ±0.2nH	100MHz	10	250MHz	750mA	0.07Ω	17GHz
LQW15AN1N6D0Z□	—	1.6nH ±0.5nH	100MHz	10	250MHz	750mA	0.07Ω	17GHz
LQW15AN1N7C0Z□	—	1.7nH ±0.2nH	100MHz	10	250MHz	640mA	0.1Ω	17GHz
LQW15AN1N7D0Z□	—	1.7nH ±0.5nH	100MHz	10	250MHz	640mA	0.1Ω	17GHz
LQW15AN1N8C0Z□	—	1.8nH ±0.2nH	100MHz	10	250MHz	460mA	0.16Ω	16GHz
LQW15AN1N8D0Z□	—	1.8nH ±0.5nH	100MHz	10	250MHz	460mA	0.16Ω	16GHz
LQW15AN2N4B0Z□	—	2.4nH ±0.1nH	100MHz	20	250MHz	850mA	0.05Ω	15GHz
LQW15AN2N4C0Z□	—	2.4nH ±0.2nH	100MHz	20	250MHz	850mA	0.05Ω	15GHz
LQW15AN2N4D0Z□	—	2.4nH ±0.5nH	100MHz	20	250MHz	850mA	0.05Ω	15GHz
LQW15AN2N5B0Z□	—	2.5nH ±0.1nH	100MHz	20	250MHz	850mA	0.05Ω	15GHz
LQW15AN2N5C0Z□	—	2.5nH ±0.2nH	100MHz	20	250MHz	850mA	0.05Ω	15GHz
LQW15AN2N5D0Z□	—	2.5nH ±0.5nH	100MHz	20	250MHz	850mA	0.05Ω	15GHz
LQW15AN2N6B0Z□	—	2.6nH ±0.1nH	100MHz	20	250MHz	850mA	0.05Ω	15GHz
LQW15AN2N6C0Z□	—	2.6nH ±0.2nH	100MHz	20	250MHz	850mA	0.05Ω	15GHz
LQW15AN2N6D0Z□	—	2.6nH ±0.5nH	100MHz	20	250MHz	850mA	0.05Ω	15GHz
LQW15AN2N7B0Z□	—	2.7nH ±0.1nH	100MHz	20	250MHz	850mA	0.05Ω	15GHz
LQW15AN2N7C0Z□	—	2.7nH ±0.2nH	100MHz	20	250MHz	850mA	0.05Ω	15GHz
LQW15AN2N7D0Z□	—	2.7nH ±0.5nH	100MHz	20	250MHz	850mA	0.05Ω	15GHz
LQW15AN2N8B0Z□	—	2.8nH ±0.1nH	100MHz	20	250MHz	850mA	0.05Ω	15GHz
LQW15AN2N8C0Z□	—	2.8nH ±0.2nH	100MHz	20	250MHz	850mA	0.05Ω	15GHz
LQW15AN2N8D0Z□	—	2.8nH ±0.5nH	100MHz	20	250MHz	850mA	0.05Ω	15GHz
LQW15AN2N9B0Z□	—	2.9nH ±0.1nH	100MHz	20	250MHz	750mA	0.07Ω	15GHz
LQW15AN2N9C0Z□	—	2.9nH ±0.2nH	100MHz	20	250MHz	750mA	0.07Ω	15GHz
LQW15AN2N9D0Z□	—	2.9nH ±0.5nH	100MHz	20	250MHz	750mA	0.07Ω	15GHz
LQW15AN3N0B0Z□	—	3nH ±0.1nH	100MHz	20	250MHz	750mA	0.07Ω	15GHz

Operating temp.range (Self-temp.rise not included): -55 to 125°C

Only for reflow soldering

\*S.R.F: Self Resonant Frequency

Continued on the following page. ↗

Continued from the preceding page. ↘

Part Number		Inductance	Inductance Test Frequency	Q (min.)	Q Test Frequency	Rated Current	Max. of DC Resistance	S.R.F.* (min.)
Infotainment	Powertrain/Safety							
LQW15AN3N0C0Z□	—	3nH ±0.2nH	100MHz	20	250MHz	750mA	0.07Ω	15GHz
LQW15AN3N0D0Z□	—	3nH ±0.5nH	100MHz	20	250MHz	750mA	0.07Ω	15GHz
LQW15AN3N1B0Z□	—	3.1nH ±0.1nH	100MHz	20	250MHz	570mA	0.13Ω	14GHz
LQW15AN3N1C0Z□	—	3.1nH ±0.2nH	100MHz	20	250MHz	570mA	0.13Ω	14GHz
LQW15AN3N1D0Z□	—	3.1nH ±0.5nH	100MHz	20	250MHz	570mA	0.13Ω	14GHz
LQW15AN3N2B0Z□	—	3.2nH ±0.1nH	100MHz	15	250MHz	500mA	0.17Ω	14GHz
LQW15AN3N2C0Z□	—	3.2nH ±0.2nH	100MHz	15	250MHz	500mA	0.17Ω	14GHz
LQW15AN3N2D0Z□	—	3.2nH ±0.5nH	100MHz	15	250MHz	500mA	0.17Ω	14GHz
LQW15AN3N9B0Z□	—	3.9nH ±0.1nH	100MHz	25	250MHz	750mA	0.07Ω	10GHz
LQW15AN3N9C0Z□	—	3.9nH ±0.2nH	100MHz	25	250MHz	750mA	0.07Ω	10GHz
LQW15AN3N9D0Z□	—	3.9nH ±0.5nH	100MHz	25	250MHz	750mA	0.07Ω	10GHz
LQW15AN4N1B0Z□	—	4.1nH ±0.1nH	100MHz	25	250MHz	750mA	0.07Ω	10GHz
LQW15AN4N1C0Z□	—	4.1nH ±0.2nH	100MHz	25	250MHz	750mA	0.07Ω	10GHz
LQW15AN4N1D0Z□	—	4.1nH ±0.5nH	100MHz	25	250MHz	750mA	0.07Ω	10GHz
LQW15AN4N3B0Z□	—	4.3nH ±0.1nH	100MHz	25	250MHz	750mA	0.07Ω	10GHz
LQW15AN4N3C0Z□	—	4.3nH ±0.2nH	100MHz	25	250MHz	750mA	0.07Ω	10GHz
LQW15AN4N3D0Z□	—	4.3nH ±0.5nH	100MHz	25	250MHz	750mA	0.07Ω	10GHz
LQW15AN4N4B0Z□	—	4.4nH ±0.1nH	100MHz	25	250MHz	750mA	0.07Ω	8GHz
LQW15AN4N4C0Z□	—	4.4nH ±0.2nH	100MHz	25	250MHz	750mA	0.07Ω	8GHz
LQW15AN4N4D0Z□	—	4.4nH ±0.5nH	100MHz	25	250MHz	750mA	0.07Ω	8GHz
LQW15AN4N5B0Z□	—	4.5nH ±0.1nH	100MHz	25	250MHz	750mA	0.07Ω	8GHz
LQW15AN4N5C0Z□	—	4.5nH ±0.2nH	100MHz	25	250MHz	750mA	0.07Ω	8GHz
LQW15AN4N5D0Z□	—	4.5nH ±0.5nH	100MHz	25	250MHz	750mA	0.07Ω	8GHz
LQW15AN4N6B0Z□	—	4.6nH ±0.1nH	100MHz	25	250MHz	750mA	0.07Ω	8GHz
LQW15AN4N6C0Z□	—	4.6nH ±0.2nH	100MHz	25	250MHz	750mA	0.07Ω	8GHz
LQW15AN4N6D0Z□	—	4.6nH ±0.5nH	100MHz	25	250MHz	750mA	0.07Ω	8GHz
LQW15AN4N7B0Z□	—	4.7nH ±0.1nH	100MHz	25	250MHz	750mA	0.07Ω	8GHz
LQW15AN4N7C0Z□	—	4.7nH ±0.2nH	100MHz	25	250MHz	750mA	0.07Ω	8GHz
LQW15AN4N7D0Z□	—	4.7nH ±0.5nH	100MHz	25	250MHz	750mA	0.07Ω	8GHz
LQW15AN4N8B0Z□	—	4.8nH ±0.1nH	100MHz	25	250MHz	750mA	0.07Ω	8GHz
LQW15AN4N8C0Z□	—	4.8nH ±0.2nH	100MHz	25	250MHz	750mA	0.07Ω	8GHz
LQW15AN4N8D0Z□	—	4.8nH ±0.5nH	100MHz	25	250MHz	750mA	0.07Ω	8GHz
LQW15AN4N9B0Z□	—	4.9nH ±0.1nH	100MHz	25	250MHz	600mA	0.12Ω	8GHz
LQW15AN4N9C0Z□	—	4.9nH ±0.2nH	100MHz	25	250MHz	600mA	0.12Ω	8GHz
LQW15AN4N9D0Z□	—	4.9nH ±0.5nH	100MHz	25	250MHz	600mA	0.12Ω	8GHz
LQW15AN5N0B0Z□	—	5nH ±0.1nH	100MHz	25	250MHz	600mA	0.12Ω	8GHz
LQW15AN5N0C0Z□	—	5nH ±0.2nH	100MHz	25	250MHz	600mA	0.12Ω	8GHz
LQW15AN5N0D0Z□	—	5nH ±0.5nH	100MHz	25	250MHz	600mA	0.12Ω	8GHz
LQW15AN5N1B0Z□	—	5.1nH ±0.1nH	100MHz	25	250MHz	600mA	0.12Ω	8GHz
LQW15AN5N1C0Z□	—	5.1nH ±0.2nH	100MHz	25	250MHz	600mA	0.12Ω	8GHz
LQW15AN5N1D0Z□	—	5.1nH ±0.5nH	100MHz	25	250MHz	600mA	0.12Ω	8GHz
LQW15AN5N8B0Z□	—	5.8nH ±0.1nH	100MHz	25	250MHz	700mA	0.09Ω	8GHz
LQW15AN5N8C0Z□	—	5.8nH ±0.2nH	100MHz	25	250MHz	700mA	0.09Ω	8GHz
LQW15AN5N8D0Z□	—	5.8nH ±0.5nH	100MHz	25	250MHz	700mA	0.09Ω	8GHz
LQW15AN6N2B0Z□	—	6.2nH ±0.1nH	100MHz	25	250MHz	700mA	0.09Ω	8GHz
LQW15AN6N2C0Z□	—	6.2nH ±0.2nH	100MHz	25	250MHz	700mA	0.09Ω	8GHz
LQW15AN6N2D0Z□	—	6.2nH ±0.5nH	100MHz	25	250MHz	700mA	0.09Ω	8GHz
LQW15AN6N3B0Z□	—	6.3nH ±0.1nH	100MHz	25	250MHz	700mA	0.09Ω	6GHz
LQW15AN6N3C0Z□	—	6.3nH ±0.2nH	100MHz	25	250MHz	700mA	0.09Ω	6GHz
LQW15AN6N3D0Z□	—	6.3nH ±0.5nH	100MHz	25	250MHz	700mA	0.09Ω	6GHz
LQW15AN6N4B0Z□	—	6.4nH ±0.1nH	100MHz	25	250MHz	700mA	0.09Ω	6GHz
LQW15AN6N4C0Z□	—	6.4nH ±0.2nH	100MHz	25	250MHz	700mA	0.09Ω	6GHz
LQW15AN6N4D0Z□	—	6.4nH ±0.5nH	100MHz	25	250MHz	700mA	0.09Ω	6GHz

Operating temp.range (Self-temp.rise not included): -55 to 125°C

Only for reflow soldering

\*S.R.F.: Self Resonant Frequency

Continued on the following page. ↗

Continued from the preceding page. ↘

Part Number		Inductance	Inductance Test Frequency	Q (min.)	Q Test Frequency	Rated Current	Max. of DC Resistance	S.R.F* (min.)
Infotainment	Powertrain/Safety							
LQW15AN6N5B0Z□	—	6.5nH ±0.1nH	100MHz	25	250MHz	700mA	0.09Ω	6GHz
LQW15AN6N5C0Z□	—	6.5nH ±0.2nH	100MHz	25	250MHz	700mA	0.09Ω	6GHz
LQW15AN6N5D0Z□	—	6.5nH ±0.5nH	100MHz	25	250MHz	700mA	0.09Ω	6GHz
LQW15AN6N6B0Z□	—	6.6nH ±0.1nH	100MHz	25	250MHz	700mA	0.09Ω	6GHz
LQW15AN6N6C0Z□	—	6.6nH ±0.2nH	100MHz	25	250MHz	700mA	0.09Ω	6GHz
LQW15AN6N6D0Z□	—	6.6nH ±0.5nH	100MHz	25	250MHz	700mA	0.09Ω	6GHz
LQW15AN6N7B0Z□	—	6.7nH ±0.1nH	100MHz	25	250MHz	700mA	0.09Ω	6GHz
LQW15AN6N7C0Z□	—	6.7nH ±0.2nH	100MHz	25	250MHz	700mA	0.09Ω	6GHz
LQW15AN6N7D0Z□	—	6.7nH ±0.5nH	100MHz	25	250MHz	700mA	0.09Ω	6GHz
LQW15AN6N8G0Z□	—	6.8nH ±2%	100MHz	25	250MHz	700mA	0.09Ω	6GHz
LQW15AN6N8H0Z□	—	6.8nH ±3%	100MHz	25	250MHz	700mA	0.09Ω	6GHz
LQW15AN6N8J0Z□	—	6.8nH ±5%	100MHz	25	250MHz	700mA	0.09Ω	6GHz
LQW15AN6N9G0Z□	—	6.9nH ±2%	100MHz	25	250MHz	570mA	0.13Ω	6GHz
LQW15AN6N9H0Z□	—	6.9nH ±3%	100MHz	25	250MHz	570mA	0.13Ω	6GHz
LQW15AN6N9J0Z□	—	6.9nH ±5%	100MHz	25	250MHz	570mA	0.13Ω	6GHz
LQW15AN7N0G0Z□	—	7nH ±2%	100MHz	25	250MHz	570mA	0.13Ω	6GHz
LQW15AN7N0H0Z□	—	7nH ±3%	100MHz	25	250MHz	570mA	0.13Ω	6GHz
LQW15AN7N0J0Z□	—	7nH ±5%	100MHz	25	250MHz	570mA	0.13Ω	6GHz
LQW15AN7N1G0Z□	—	7.1nH ±2%	100MHz	25	250MHz	570mA	0.13Ω	6GHz
LQW15AN7N1H0Z□	—	7.1nH ±3%	100MHz	25	250MHz	570mA	0.13Ω	6GHz
LQW15AN7N1J0Z□	—	7.1nH ±5%	100MHz	25	250MHz	570mA	0.13Ω	6GHz
LQW15AN7N2G0Z□	—	7.2nH ±2%	100MHz	25	250MHz	570mA	0.13Ω	6GHz
LQW15AN7N2H0Z□	—	7.2nH ±3%	100MHz	25	250MHz	570mA	0.13Ω	6GHz
LQW15AN7N2J0Z□	—	7.2nH ±5%	100MHz	25	250MHz	570mA	0.13Ω	6GHz
LQW15AN7N3G0Z□	—	7.3nH ±2%	100MHz	25	250MHz	570mA	0.13Ω	6GHz
LQW15AN7N3H0Z□	—	7.3nH ±3%	100MHz	25	250MHz	570mA	0.13Ω	6GHz
LQW15AN7N3J0Z□	—	7.3nH ±5%	100MHz	25	250MHz	570mA	0.13Ω	6GHz
LQW15AN7N5G0Z□	—	7.5nH ±2%	100MHz	25	250MHz	570mA	0.13Ω	6GHz
LQW15AN7N5H0Z□	—	7.5nH ±3%	100MHz	25	250MHz	570mA	0.13Ω	6GHz
LQW15AN7N5J0Z□	—	7.5nH ±5%	100MHz	25	250MHz	570mA	0.13Ω	6GHz
LQW15AN8N2G0Z□	—	8.2nH ±2%	100MHz	25	250MHz	540mA	0.14Ω	5.5GHz
LQW15AN8N2H0Z□	—	8.2nH ±3%	100MHz	25	250MHz	540mA	0.14Ω	5.5GHz
LQW15AN8N2J0Z□	—	8.2nH ±5%	100MHz	25	250MHz	540mA	0.14Ω	5.5GHz
LQW15AN8N6G0Z□	—	8.6nH ±2%	100MHz	25	250MHz	540mA	0.14Ω	5.5GHz
LQW15AN8N6H0Z□	—	8.6nH ±3%	100MHz	25	250MHz	540mA	0.14Ω	5.5GHz
LQW15AN8N6J0Z□	—	8.6nH ±5%	100MHz	25	250MHz	540mA	0.14Ω	5.5GHz
LQW15AN8N7G0Z□	—	8.7nH ±2%	100MHz	25	250MHz	540mA	0.14Ω	5.5GHz
LQW15AN8N7H0Z□	—	8.7nH ±3%	100MHz	25	250MHz	540mA	0.14Ω	5.5GHz
LQW15AN8N7J0Z□	—	8.7nH ±5%	100MHz	25	250MHz	540mA	0.14Ω	5.5GHz
LQW15AN8N8G0Z□	—	8.8nH ±2%	100MHz	25	250MHz	540mA	0.14Ω	5.5GHz
LQW15AN8N8H0Z□	—	8.8nH ±3%	100MHz	25	250MHz	540mA	0.14Ω	5.5GHz
LQW15AN8N8J0Z□	—	8.8nH ±5%	100MHz	25	250MHz	540mA	0.14Ω	5.5GHz
LQW15AN8N9G0Z□	—	8.9nH ±2%	100MHz	25	250MHz	540mA	0.14Ω	5.5GHz
LQW15AN8N9H0Z□	—	8.9nH ±3%	100MHz	25	250MHz	540mA	0.14Ω	5.5GHz
LQW15AN8N9J0Z□	—	8.9nH ±5%	100MHz	25	250MHz	540mA	0.14Ω	5.5GHz
LQW15AN9N0G0Z□	—	9nH ±2%	100MHz	25	250MHz	540mA	0.14Ω	5.5GHz
LQW15AN9N0H0Z□	—	9nH ±3%	100MHz	25	250MHz	540mA	0.14Ω	5.5GHz
LQW15AN9N0J0Z□	—	9nH ±5%	100MHz	25	250MHz	540mA	0.14Ω	5.5GHz
LQW15AN9N1G0Z□	—	9.1nH ±2%	100MHz	25	250MHz	540mA	0.14Ω	5.5GHz
LQW15AN9N1H0Z□	—	9.1nH ±3%	100MHz	25	250MHz	540mA	0.14Ω	5.5GHz
LQW15AN9N1J0Z□	—	9.1nH ±5%	100MHz	25	250MHz	540mA	0.14Ω	5.5GHz
LQW15AN9N2G0Z□	—	9.2nH ±2%	100MHz	25	250MHz	540mA	0.14Ω	5.5GHz
LQW15AN9N2H0Z□	—	9.2nH ±3%	100MHz	25	250MHz	540mA	0.14Ω	5.5GHz

Operating temp.range (Self-temp.rise not included): -55 to 125°C

Only for reflow soldering

\*S.R.F: Self Resonant Frequency

Continued on the following page. ↗



Continued from the preceding page. ↘

Part Number		Inductance	Inductance Test Frequency	Q (min.)	Q Test Frequency	Rated Current	Max. of DC Resistance	S.R.F.* (min.)
Infotainment	Powertrain/Safety							
LQW15AN9N2J0Z□	—	9.2nH ±5%	100MHz	25	250MHz	540mA	0.14Ω	5.5GHz
LQW15AN9N3G0Z□	—	9.3nH ±2%	100MHz	25	250MHz	540mA	0.14Ω	5.5GHz
LQW15AN9N3H0Z□	—	9.3nH ±3%	100MHz	25	250MHz	540mA	0.14Ω	5.5GHz
LQW15AN9N3J0Z□	—	9.3nH ±5%	100MHz	25	250MHz	540mA	0.14Ω	5.5GHz
LQW15AN9N4G0Z□	—	9.4nH ±2%	100MHz	25	250MHz	540mA	0.14Ω	5.5GHz
LQW15AN9N4H0Z□	—	9.4nH ±3%	100MHz	25	250MHz	540mA	0.14Ω	5.5GHz
LQW15AN9N4J0Z□	—	9.4nH ±5%	100MHz	25	250MHz	540mA	0.14Ω	5.5GHz
LQW15AN9N5G0Z□	—	9.5nH ±2%	100MHz	25	250MHz	540mA	0.14Ω	5.5GHz
LQW15AN9N5H0Z□	—	9.5nH ±3%	100MHz	25	250MHz	540mA	0.14Ω	5.5GHz
LQW15AN9N5J0Z□	—	9.5nH ±5%	100MHz	25	250MHz	540mA	0.14Ω	5.5GHz
LQW15AN9N6G0Z□	—	9.6nH ±2%	100MHz	25	250MHz	540mA	0.14Ω	5.5GHz
LQW15AN9N6H0Z□	—	9.6nH ±3%	100MHz	25	250MHz	540mA	0.14Ω	5.5GHz
LQW15AN9N6J0Z□	—	9.6nH ±5%	100MHz	25	250MHz	540mA	0.14Ω	5.5GHz
LQW15AN9N7G0Z□	—	9.7nH ±2%	100MHz	25	250MHz	540mA	0.14Ω	5.5GHz
LQW15AN9N7H0Z□	—	9.7nH ±3%	100MHz	25	250MHz	540mA	0.14Ω	5.5GHz
LQW15AN9N7J0Z□	—	9.7nH ±5%	100MHz	25	250MHz	540mA	0.14Ω	5.5GHz
LQW15AN9N8G0Z□	—	9.8nH ±2%	100MHz	25	250MHz	540mA	0.14Ω	5.5GHz
LQW15AN9N8H0Z□	—	9.8nH ±3%	100MHz	25	250MHz	540mA	0.14Ω	5.5GHz
LQW15AN9N8J0Z□	—	9.8nH ±5%	100MHz	25	250MHz	540mA	0.14Ω	5.5GHz
LQW15AN9N9G0Z□	—	9.9nH ±2%	100MHz	25	250MHz	540mA	0.14Ω	5.5GHz
LQW15AN9N9H0Z□	—	9.9nH ±3%	100MHz	25	250MHz	540mA	0.14Ω	5.5GHz
LQW15AN9N9J0Z□	—	9.9nH ±5%	100MHz	25	250MHz	540mA	0.14Ω	5.5GHz
LQW15AN10NG0Z□	—	10nH ±2%	100MHz	25	250MHz	500mA	0.17Ω	5.5GHz
LQW15AN10NH0Z□	—	10nH ±3%	100MHz	25	250MHz	500mA	0.17Ω	5.5GHz
LQW15AN10NJ0Z□	—	10nH ±5%	100MHz	25	250MHz	500mA	0.17Ω	5.5GHz
LQW15AN11NG0Z□	—	11nH ±2%	100MHz	30	250MHz	500mA	0.14Ω	5.5GHz
LQW15AN11NH0Z□	—	11nH ±3%	100MHz	30	250MHz	500mA	0.14Ω	5.5GHz
LQW15AN11NJ0Z□	—	11nH ±5%	100MHz	30	250MHz	500mA	0.14Ω	5.5GHz
LQW15AN12NG0Z□	—	12nH ±2%	100MHz	30	250MHz	500mA	0.14Ω	5.5GHz
LQW15AN12NH0Z□	—	12nH ±3%	100MHz	30	250MHz	500mA	0.14Ω	5.5GHz
LQW15AN12NJ0Z□	—	12nH ±5%	100MHz	30	250MHz	500mA	0.14Ω	5.5GHz
LQW15AN13NG0Z□	—	13nH ±2%	100MHz	25	250MHz	430mA	0.21Ω	5GHz
LQW15AN13NH0Z□	—	13nH ±3%	100MHz	25	250MHz	430mA	0.21Ω	5GHz
LQW15AN13NJ0Z□	—	13nH ±5%	100MHz	25	250MHz	430mA	0.21Ω	5GHz
LQW15AN15NG0Z□	—	15nH ±2%	100MHz	30	250MHz	460mA	0.16Ω	5GHz
LQW15AN15NH0Z□	—	15nH ±3%	100MHz	30	250MHz	460mA	0.16Ω	5GHz
LQW15AN15NJ0Z□	—	15nH ±5%	100MHz	30	250MHz	460mA	0.16Ω	5GHz
LQW15AN16NG0Z□	—	16nH ±2%	100MHz	25	250MHz	370mA	0.24Ω	4.5GHz
LQW15AN16NH0Z□	—	16nH ±3%	100MHz	25	250MHz	370mA	0.24Ω	4.5GHz
LQW15AN16NJ0Z□	—	16nH ±5%	100MHz	25	250MHz	370mA	0.24Ω	4.5GHz
LQW15AN18NG0Z□	—	18nH ±2%	100MHz	25	250MHz	370mA	0.27Ω	4.5GHz
LQW15AN18NH0Z□	—	18nH ±3%	100MHz	25	250MHz	370mA	0.27Ω	4.5GHz
LQW15AN18NJ0Z□	—	18nH ±5%	100MHz	25	250MHz	370mA	0.27Ω	4.5GHz
LQW15AN19NG0Z□	—	19nH ±2%	100MHz	25	250MHz	370mA	0.27Ω	4.5GHz
LQW15AN19NH0Z□	—	19nH ±3%	100MHz	25	250MHz	370mA	0.27Ω	4.5GHz
LQW15AN19NJ0Z□	—	19nH ±5%	100MHz	25	250MHz	370mA	0.27Ω	4.5GHz
LQW15AN20NG0Z□	—	20nH ±2%	100MHz	25	250MHz	370mA	0.27Ω	4GHz
LQW15AN20NH0Z□	—	20nH ±3%	100MHz	25	250MHz	370mA	0.27Ω	4GHz
LQW15AN20NJ0Z□	—	20nH ±5%	100MHz	25	250MHz	370mA	0.27Ω	4GHz
LQW15AN22NG0Z□	—	22nH ±2%	100MHz	25	250MHz	310mA	0.3Ω	4GHz
LQW15AN22NH0Z□	—	22nH ±3%	100MHz	25	250MHz	310mA	0.3Ω	4GHz
LQW15AN22NJ0Z□	—	22nH ±5%	100MHz	25	250MHz	310mA	0.3Ω	4GHz
LQW15AN23NG0Z□	—	23nH ±2%	100MHz	25	250MHz	310mA	0.3Ω	3.8GHz

Operating temp.range (Self-temp.rise not included): -55 to 125°C

Only for reflow soldering

\*S.R.F.: Self Resonant Frequency

Chip Ferrite Bead  
 Chip EMIFIL  
 Chip Common Mode Choke Coil  
 Block Type EMIFIL  
 Microchip Transformer (Ballun)  
 Inductors for Power Lines  
 Inductors for General Circuits  
 RF Inductors

Continued from the preceding page. ↘

Part Number		Inductance	Inductance Test Frequency	Q (min.)	Q Test Frequency	Rated Current	Max. of DC Resistance	S.R.F* (min.)
Infotainment	Powertrain/Safety							
LQW15AN23NH0Z□	—	23nH ±3%	100MHz	25	250MHz	310mA	0.3Ω	3.8GHz
LQW15AN23NJ0Z□	—	23nH ±5%	100MHz	25	250MHz	310mA	0.3Ω	3.8GHz
LQW15AN24NG0Z□	—	24nH ±2%	100MHz	25	250MHz	280mA	0.52Ω	3.5GHz
LQW15AN24NH0Z□	—	24nH ±3%	100MHz	25	250MHz	280mA	0.52Ω	3.5GHz
LQW15AN24NJ0Z□	—	24nH ±5%	100MHz	25	250MHz	280mA	0.52Ω	3.5GHz
LQW15AN27NG0Z□	—	27nH ±2%	100MHz	25	250MHz	280mA	0.52Ω	3.5GHz
LQW15AN27NH0Z□	—	27nH ±3%	100MHz	25	250MHz	280mA	0.52Ω	3.5GHz
LQW15AN27NJ0Z□	—	27nH ±5%	100MHz	25	250MHz	280mA	0.52Ω	3.5GHz
LQW15AN30NG0Z□	—	30nH ±2%	100MHz	25	250MHz	270mA	0.58Ω	3.3GHz
LQW15AN30NH0Z□	—	30nH ±3%	100MHz	25	250MHz	270mA	0.58Ω	3.3GHz
LQW15AN30NJ0Z□	—	30nH ±5%	100MHz	25	250MHz	270mA	0.58Ω	3.3GHz
LQW15AN33NG0Z□	—	33nH ±2%	100MHz	25	250MHz	260mA	0.63Ω	3.2GHz
LQW15AN33NH0Z□	—	33nH ±3%	100MHz	25	250MHz	260mA	0.63Ω	3.2GHz
LQW15AN33NJ0Z□	—	33nH ±5%	100MHz	25	250MHz	260mA	0.63Ω	3.2GHz
LQW15AN36NG0Z□	—	36nH ±2%	100MHz	25	250MHz	260mA	0.63Ω	3.1GHz
LQW15AN36NH0Z□	—	36nH ±3%	100MHz	25	250MHz	260mA	0.63Ω	3.1GHz
LQW15AN36NJ0Z□	—	36nH ±5%	100MHz	25	250MHz	260mA	0.63Ω	3.1GHz
LQW15AN39NG0Z□	—	39nH ±2%	100MHz	25	250MHz	250mA	0.7Ω	3GHz
LQW15AN39NH0Z□	—	39nH ±3%	100MHz	25	250MHz	250mA	0.7Ω	3GHz
LQW15AN39NJ0Z□	—	39nH ±5%	100MHz	25	250MHz	250mA	0.7Ω	3GHz
LQW15AN40NG0Z□	—	40nH ±2%	100MHz	25	250MHz	250mA	0.7Ω	3GHz
LQW15AN40NH0Z□	—	40nH ±3%	100MHz	25	250MHz	250mA	0.7Ω	3GHz
LQW15AN40NJ0Z□	—	40nH ±5%	100MHz	25	250MHz	250mA	0.7Ω	3GHz
LQW15AN43NG0Z□	—	43nH ±2%	100MHz	25	250MHz	250mA	0.7Ω	3GHz
LQW15AN43NH0Z□	—	43nH ±3%	100MHz	25	250MHz	250mA	0.7Ω	3GHz
LQW15AN43NJ0Z□	—	43nH ±5%	100MHz	25	250MHz	250mA	0.7Ω	3GHz
LQW15AN47NG0Z□	—	47nH ±2%	100MHz	25	200MHz	210mA	1.08Ω	2.9GHz
LQW15AN47NH0Z□	—	47nH ±3%	100MHz	25	200MHz	210mA	1.08Ω	2.9GHz
LQW15AN47NJ0Z□	—	47nH ±5%	100MHz	25	200MHz	210mA	1.08Ω	2.9GHz
LQW15AN51NG0Z□	—	51nH ±2%	100MHz	25	200MHz	210mA	1.08Ω	2.85GHz
LQW15AN51NH0Z□	—	51nH ±3%	100MHz	25	200MHz	210mA	1.08Ω	2.85GHz
LQW15AN51NJ0Z□	—	51nH ±5%	100MHz	25	200MHz	210mA	1.08Ω	2.85GHz
LQW15AN56NG0Z□	—	56nH ±2%	100MHz	25	200MHz	200mA	1.17Ω	2.8GHz
LQW15AN56NH0Z□	—	56nH ±3%	100MHz	25	200MHz	200mA	1.17Ω	2.8GHz
LQW15AN56NJ0Z□	—	56nH ±5%	100MHz	25	200MHz	200mA	1.17Ω	2.8GHz
LQW15AN62NG0Z□	—	62nH ±2%	100MHz	20	200MHz	145mA	1.82Ω	2.6GHz
LQW15AN62NH0Z□	—	62nH ±3%	100MHz	20	200MHz	145mA	1.82Ω	2.6GHz
LQW15AN62NJ0Z□	—	62nH ±5%	100MHz	20	200MHz	145mA	1.82Ω	2.6GHz
LQW15AN68NG0Z□	—	68nH ±2%	100MHz	20	200MHz	140mA	1.96Ω	2.5GHz
LQW15AN68NJ0Z□	—	68nH ±5%	100MHz	20	200MHz	140mA	1.96Ω	2.5GHz
LQW15AN72NG0Z□	—	72nH ±2%	100MHz	20	150MHz	135mA	2.1Ω	2.5GHz
LQW15AN72NJ0Z□	—	72nH ±5%	100MHz	20	150MHz	135mA	2.1Ω	2.5GHz
LQW15AN75NG0Z□	—	75nH ±2%	100MHz	20	150MHz	135mA	2.1Ω	2.4GHz
LQW15AN75NJ0Z□	—	75nH ±5%	100MHz	20	150MHz	135mA	2.1Ω	2.4GHz
LQW15AN82NG0Z□	—	82nH ±2%	100MHz	20	150MHz	130mA	2.24Ω	2.3GHz
LQW15AN82NJ0Z□	—	82nH ±5%	100MHz	20	150MHz	130mA	2.24Ω	2.3GHz
LQW15AN91NG0Z□	—	91nH ±2%	100MHz	20	150MHz	125mA	2.38Ω	2.1GHz
LQW15AN91NJ0Z□	—	91nH ±5%	100MHz	20	150MHz	125mA	2.38Ω	2.1GHz
LQW15ANR10J0Z□	—	100nH ±5%	100MHz	20	150MHz	120mA	2.52Ω	1.5GHz
LQW15ANR12J0Z□	—	120nH ±5%	100MHz	20	150MHz	110mA	2.66Ω	1GHz

Operating temp.range (Self-temp.rise not included): -55 to 125°C

Only for reflow soldering

\*S.R.F: Self Resonant Frequency

Continued on the following page. ↗

Chip Ferrite Bead

Chip EMI/FIL

Chip Common Mode Choke Coil

Block Type EMI/FIL

Microchip Transformer (Balun)

Inductors for Power Lines

Inductors for General Circuits

RF Inductors

Continued from the preceding page. ↘

### Inductance-Frequency Characteristics (Typ.)

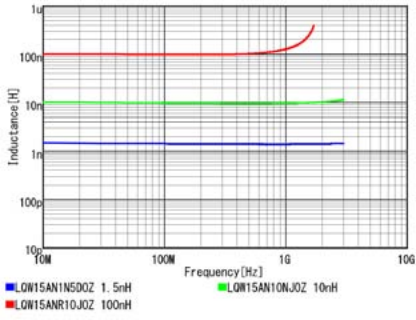

### Q-Frequency Characteristics (Typ.)

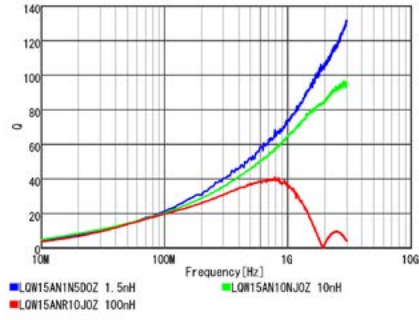

Chip Ferrite Bead

Chip EMIFIL

Chip Common Mode Choke Coil

Block Type EMIFIL

Microchip Transformer (Balun)

Inductors for Power Lines

Inductors for General Circuits

RF Inductors



# RF Inductors

## LQW15AN\_1Z Series 0402 (1005) inch (mm)

### Specifications Sheet (with cautions/mounting/packaging)

Infotainment	<a href="https://search.murata.co.jp/Ceramy/image/img/P02/JELF243A-9115.pdf">https://search.murata.co.jp/Ceramy/image/img/P02/JELF243A-9115.pdf</a>
Powertrain/Safety	—

### Appearance/Dimensions

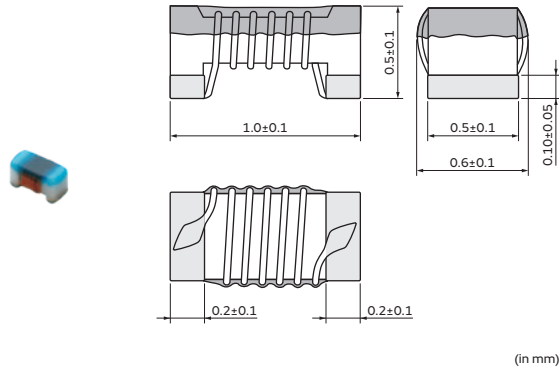

### Packaging

Code	Packaging	Minimum Quantity
D	ø180mm Paper Taping	10000
B	Packing in Bulk	500

### Rated Value (□: packaging code)

Part Number		Inductance	Inductance Test Frequency	Q (min.)	Q Test Frequency	Rated Current	Max. of DC Resistance	S.R.F.* (min.)
Infotainment	Powertrain/Safety							
LQW15AN1N3C1Z□	—	1.3nH ±0.2nH	100MHz	20	250MHz	1200mA	0.017Ω	16GHz
LQW15AN1N3D1Z□	—	1.3nH ±0.5nH	100MHz	20	250MHz	1200mA	0.017Ω	16GHz
LQW15AN1N4C1Z□	—	1.4nH ±0.2nH	100MHz	25	250MHz	1100mA	0.019Ω	15GHz
LQW15AN1N4D1Z□	—	1.4nH ±0.5nH	100MHz	25	250MHz	1100mA	0.019Ω	15GHz
LQW15AN2N2C1Z□	—	2.2nH ±0.2nH	100MHz	25	250MHz	1000mA	0.027Ω	14GHz
LQW15AN2N2D1Z□	—	2.2nH ±0.5nH	100MHz	25	250MHz	1000mA	0.027Ω	14GHz
LQW15AN2N3C1Z□	—	2.3nH ±0.2nH	100MHz	25	250MHz	1000mA	0.027Ω	14GHz
LQW15AN2N3D1Z□	—	2.3nH ±0.5nH	100MHz	25	250MHz	1000mA	0.027Ω	14GHz
LQW15AN2N4D1Z□	—	2.4nH ±0.5nH	100MHz	25	250MHz	1000mA	0.027Ω	14GHz
LQW15AN3N3D1Z□	—	3.3nH ±0.5nH	100MHz	30	250MHz	900mA	0.04Ω	12GHz
LQW15AN3N4C1Z□	—	3.4nH ±0.2nH	100MHz	30	250MHz	900mA	0.04Ω	12GHz
LQW15AN3N4D1Z□	—	3.4nH ±0.5nH	100MHz	30	250MHz	900mA	0.04Ω	12GHz
LQW15AN3N5C1Z□	—	3.5nH ±0.2nH	100MHz	30	250MHz	900mA	0.04Ω	9.5GHz
LQW15AN3N5D1Z□	—	3.5nH ±0.5nH	100MHz	30	250MHz	900mA	0.04Ω	9.5GHz
LQW15AN3N6C1Z□	—	3.6nH ±0.2nH	100MHz	30	250MHz	900mA	0.04Ω	9.5GHz
LQW15AN3N6D1Z□	—	3.6nH ±0.5nH	100MHz	30	250MHz	900mA	0.04Ω	9.5GHz
LQW15AN3N8C1Z□	—	3.8nH ±0.2nH	100MHz	30	250MHz	900mA	0.04Ω	7GHz
LQW15AN3N8D1Z□	—	3.8nH ±0.5nH	100MHz	30	250MHz	900mA	0.04Ω	7GHz
LQW15AN3N9D1Z□	—	3.9nH ±0.5nH	100MHz	30	250MHz	900mA	0.04Ω	7GHz
LQW15AN4NOC1Z□	—	4nH ±0.2nH	100MHz	30	250MHz	800mA	0.051Ω	6.5GHz
LQW15AN4NOD1Z□	—	4nH ±0.5nH	100MHz	30	250MHz	800mA	0.051Ω	6.5GHz
LQW15AN4N2C1Z□	—	4.2nH ±0.2nH	100MHz	30	250MHz	800mA	0.051Ω	6.5GHz
LQW15AN4N2D1Z□	—	4.2nH ±0.5nH	100MHz	30	250MHz	800mA	0.051Ω	6.5GHz
LQW15AN4N7D1Z□	—	4.7nH ±0.5nH	100MHz	30	250MHz	800mA	0.051Ω	8GHz
LQW15AN5N1C1Z□	—	5.1nH ±0.2nH	100MHz	30	250MHz	800mA	0.051Ω	8GHz
LQW15AN5N1D1Z□	—	5.1nH ±0.5nH	100MHz	30	250MHz	800mA	0.051Ω	8GHz
LQW15AN5N2C1Z□	—	5.2nH ±0.2nH	100MHz	30	250MHz	800mA	0.051Ω	8GHz
LQW15AN5N2D1Z□	—	5.2nH ±0.5nH	100MHz	30	250MHz	800mA	0.051Ω	8GHz

Operating temp.range (Self-temp.rise not included): -55 to 125°C

Only for reflow soldering

\*S.R.F.: Self Resonant Frequency

Continued on the following page. ↗

Continued from the preceding page. ↘

Part Number		Inductance	Inductance Test Frequency	Q (min.)	Q Test Frequency	Rated Current	Max. of DC Resistance	S.R.F* (min.)
Infotainment	Powertrain/Safety							
LQW15AN5N3C1Z	—	5.3nH ±0.2nH	100MHz	30	250MHz	800mA	0.051Ω	8GHz
LQW15AN5N3D1Z	—	5.3nH ±0.5nH	100MHz	30	250MHz	800mA	0.051Ω	8GHz
LQW15AN5N4C1Z	—	5.4nH ±0.2nH	100MHz	30	250MHz	800mA	0.051Ω	8GHz
LQW15AN5N4D1Z	—	5.4nH ±0.5nH	100MHz	30	250MHz	800mA	0.051Ω	8GHz
LQW15AN5N5C1Z	—	5.5nH ±0.2nH	100MHz	30	250MHz	800mA	0.051Ω	8GHz
LQW15AN5N5D1Z	—	5.5nH ±0.5nH	100MHz	30	250MHz	800mA	0.051Ω	8GHz
LQW15AN5N6C1Z	—	5.6nH ±0.2nH	100MHz	30	250MHz	800mA	0.051Ω	8GHz
LQW15AN5N6D1Z	—	5.6nH ±0.5nH	100MHz	30	250MHz	800mA	0.051Ω	8GHz
LQW15AN5N7C1Z	—	5.7nH ±0.2nH	100MHz	30	250MHz	800mA	0.051Ω	8GHz
LQW15AN5N7D1Z	—	5.7nH ±0.5nH	100MHz	30	250MHz	800mA	0.051Ω	8GHz
LQW15AN5N9C1Z	—	5.9nH ±0.2nH	100MHz	30	250MHz	760mA	0.056Ω	7.7GHz
LQW15AN5N9D1Z	—	5.9nH ±0.5nH	100MHz	30	250MHz	760mA	0.056Ω	7.7GHz
LQW15AN6N0C1Z	—	6nH ±0.2nH	100MHz	30	250MHz	760mA	0.056Ω	7.7GHz
LQW15AN6N0D1Z	—	6nH ±0.5nH	100MHz	30	250MHz	760mA	0.056Ω	7.7GHz
LQW15AN6N1C1Z	—	6.1nH ±0.2nH	100MHz	30	250MHz	760mA	0.056Ω	7.7GHz
LQW15AN6N1D1Z	—	6.1nH ±0.5nH	100MHz	30	250MHz	760mA	0.056Ω	7.7GHz
LQW15AN7N4C1Z	—	7.4nH ±0.2nH	100MHz	30	250MHz	750mA	0.058Ω	6.8GHz
LQW15AN7N4D1Z	—	7.4nH ±0.5nH	100MHz	30	250MHz	750mA	0.058Ω	6.8GHz
LQW15AN7N6C1Z	—	7.6nH ±0.2nH	100MHz	30	250MHz	750mA	0.058Ω	6.8GHz
LQW15AN7N6D1Z	—	7.6nH ±0.5nH	100MHz	30	250MHz	750mA	0.058Ω	6.8GHz
LQW15AN7N7C1Z	—	7.7nH ±0.2nH	100MHz	30	250MHz	750mA	0.058Ω	6.8GHz
LQW15AN7N7D1Z	—	7.7nH ±0.5nH	100MHz	30	250MHz	750mA	0.058Ω	6.8GHz
LQW15AN7N8C1Z	—	7.8nH ±0.2nH	100MHz	30	250MHz	750mA	0.058Ω	6.8GHz
LQW15AN7N8D1Z	—	7.8nH ±0.5nH	100MHz	30	250MHz	750mA	0.058Ω	6.8GHz
LQW15AN7N9C1Z	—	7.9nH ±0.2nH	100MHz	30	250MHz	640mA	0.079Ω	7.5GHz
LQW15AN7N9D1Z	—	7.9nH ±0.5nH	100MHz	30	250MHz	640mA	0.079Ω	7.5GHz
LQW15AN8N0C1Z	—	8nH ±0.2nH	100MHz	30	250MHz	640mA	0.079Ω	7.5GHz
LQW15AN8N0D1Z	—	8nH ±0.5nH	100MHz	30	250MHz	640mA	0.079Ω	7.5GHz
LQW15AN8N1C1Z	—	8.1nH ±0.2nH	100MHz	30	250MHz	640mA	0.079Ω	7.5GHz
LQW15AN8N1D1Z	—	8.1nH ±0.5nH	100MHz	30	250MHz	640mA	0.079Ω	7.5GHz
LQW15AN8N3C1Z	—	8.3nH ±0.2nH	100MHz	30	250MHz	640mA	0.079Ω	7.5GHz
LQW15AN8N3D1Z	—	8.3nH ±0.5nH	100MHz	30	250MHz	640mA	0.079Ω	7.5GHz
LQW15AN8N4C1Z	—	8.4nH ±0.2nH	100MHz	30	250MHz	640mA	0.079Ω	7.5GHz
LQW15AN8N4D1Z	—	8.4nH ±0.5nH	100MHz	30	250MHz	640mA	0.079Ω	7.5GHz

Operating temp.range (Self-temp.rise not included): -55 to 125°C  
 Only for reflow soldering  
 \*S.R.F: Self Resonant Frequency

**Inductance-Frequency Characteristics (Typ.)**

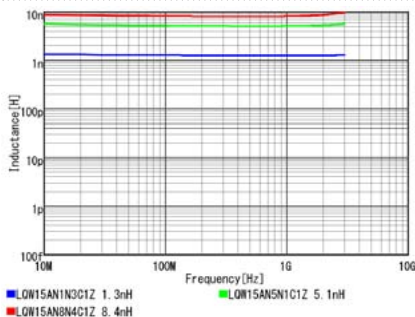

**Q-Frequency Characteristics (Typ.)**

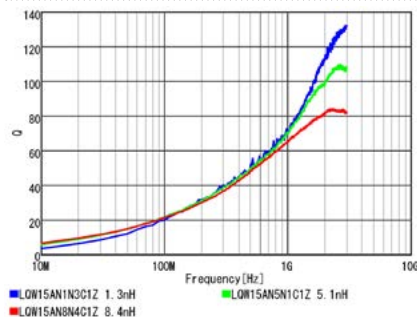

Chip Ferrite Bead

Chip EMIFIL

Chip Common Mode Choke Coil

Block Type EMIFIL

Microchip Transformer (Ballun)

Inductors for Power Lines

Inductors for General Circuits

RF Inductors

# RF Inductors

## LQW15AN\_8Z Series 0402 (1005) inch (mm)

### Specifications Sheet (with cautions/mounting/packaging)

Infotainment	<a href="https://search.murata.co.jp/Ceramy/image/img/P02/JELF243A-9138.pdf">https://search.murata.co.jp/Ceramy/image/img/P02/JELF243A-9138.pdf</a>
Powertrain/Safety	—

### Appearance/Dimensions

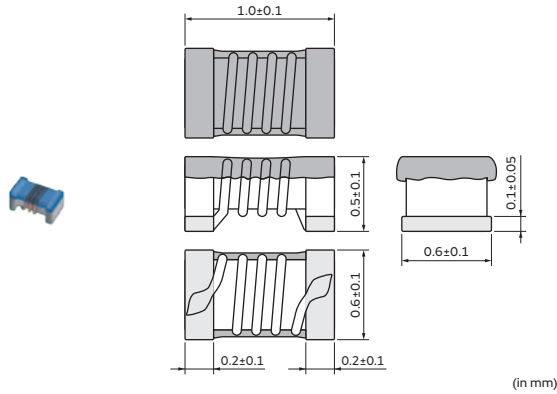

### Packaging

Code	Packaging	Minimum Quantity
D	ø180mm Paper Taping	10000
B	Packing in Bulk	500

### Rated Value (□: packaging code)

Part Number		Inductance	Inductance Test Frequency	Q (min.)	Q Test Frequency	Rated Current	Max. of DC Resistance	S.R.F* (min.)
Infotainment	Powertrain/Safety							
LQW15AN1N3C8Z□	—	1.3nH ±0.2nH	100MHz	20	250MHz	3150mA	0.012Ω	18GHz
LQW15AN1N3D8Z□	—	1.3nH ±0.5nH	100MHz	20	250MHz	3150mA	0.012Ω	18GHz
LQW15AN1N5C8Z□	—	1.5nH ±0.2nH	100MHz	20	250MHz	2100mA	0.028Ω	18GHz
LQW15AN1N5D8Z□	—	1.5nH ±0.5nH	100MHz	20	250MHz	2100mA	0.028Ω	18GHz
LQW15AN1N6C8Z□	—	1.6nH ±0.2nH	100MHz	20	250MHz	1450mA	0.045Ω	18GHz
LQW15AN1N6D8Z□	—	1.6nH ±0.5nH	100MHz	20	250MHz	1450mA	0.045Ω	18GHz
LQW15AN1N7C8Z□	—	1.7nH ±0.2nH	100MHz	20	250MHz	1150mA	0.065Ω	18GHz
LQW15AN1N7D8Z□	—	1.7nH ±0.5nH	100MHz	20	250MHz	1150mA	0.065Ω	18GHz
LQW15AN2N2B8Z□	—	2.2nH ±0.1nH	100MHz	30	250MHz	2530mA	0.022Ω	15.5GHz
LQW15AN2N2C8Z□	—	2.2nH ±0.2nH	100MHz	30	250MHz	2530mA	0.022Ω	15.5GHz
LQW15AN2N2D8Z□	—	2.2nH ±0.5nH	100MHz	30	250MHz	2530mA	0.022Ω	15.5GHz
LQW15AN2N2G8Z□	—	2.2nH ±2%	100MHz	30	250MHz	2530mA	0.022Ω	15.5GHz
LQW15AN2N3B8Z□	—	2.3nH ±0.1nH	100MHz	30	250MHz	2530mA	0.022Ω	15.5GHz
LQW15AN2N3C8Z□	—	2.3nH ±0.2nH	100MHz	30	250MHz	2530mA	0.022Ω	15.5GHz
LQW15AN2N3D8Z□	—	2.3nH ±0.5nH	100MHz	30	250MHz	2530mA	0.022Ω	15.5GHz
LQW15AN2N3G8Z□	—	2.3nH ±2%	100MHz	30	250MHz	2530mA	0.022Ω	15.5GHz
LQW15AN2N4B8Z□	—	2.4nH ±0.1nH	100MHz	30	250MHz	2530mA	0.022Ω	15.5GHz
LQW15AN2N4C8Z□	—	2.4nH ±0.2nH	100MHz	30	250MHz	2530mA	0.022Ω	15.5GHz
LQW15AN2N4D8Z□	—	2.4nH ±0.5nH	100MHz	30	250MHz	2530mA	0.022Ω	15.5GHz
LQW15AN2N4G8Z□	—	2.4nH ±2%	100MHz	30	250MHz	2530mA	0.022Ω	15.5GHz
LQW15AN2N5B8Z□	—	2.5nH ±0.1nH	100MHz	30	250MHz	2100mA	0.03Ω	15.5GHz
LQW15AN2N5C8Z□	—	2.5nH ±0.2nH	100MHz	30	250MHz	2100mA	0.03Ω	15.5GHz
LQW15AN2N5D8Z□	—	2.5nH ±0.5nH	100MHz	30	250MHz	2100mA	0.03Ω	15.5GHz
LQW15AN2N5G8Z□	—	2.5nH ±2%	100MHz	30	250MHz	2100mA	0.03Ω	15.5GHz
LQW15AN2N6B8Z□	—	2.6nH ±0.1nH	100MHz	30	250MHz	1950mA	0.035Ω	14.5GHz
LQW15AN2N6C8Z□	—	2.6nH ±0.2nH	100MHz	30	250MHz	1950mA	0.035Ω	14.5GHz
LQW15AN2N6D8Z□	—	2.6nH ±0.5nH	100MHz	30	250MHz	1950mA	0.035Ω	14.5GHz
LQW15AN2N6G8Z□	—	2.6nH ±2%	100MHz	30	250MHz	1950mA	0.035Ω	14.5GHz

Operating temp.range (Self-temp.rise not included): -55 to 125°C

Only for reflow soldering

\*S.R.F: Self Resonant Frequency

Continued on the following page. ↗

Continued from the preceding page. ↘

Part Number		Inductance	Inductance Test Frequency	Q (min.)	Q Test Frequency	Rated Current	Max. of DC Resistance	S.R.F.* (min.)
Infotainment	Powertrain/Safety							
LQW15AN2N7B8Z□	—	2.7nH ±0.1nH	100MHz	28	250MHz	1500mA	0.047Ω	14GHz
LQW15AN2N7C8Z□	—	2.7nH ±0.2nH	100MHz	28	250MHz	1500mA	0.047Ω	14GHz
LQW15AN2N7D8Z□	—	2.7nH ±0.5nH	100MHz	28	250MHz	1500mA	0.047Ω	14GHz
LQW15AN2N7G8Z□	—	2.7nH ±2%	100MHz	28	250MHz	1500mA	0.047Ω	14GHz
LQW15AN2N8B8Z□	—	2.8nH ±0.1nH	100MHz	27	250MHz	1500mA	0.047Ω	13.5GHz
LQW15AN2N8C8Z□	—	2.8nH ±0.2nH	100MHz	27	250MHz	1500mA	0.047Ω	13.5GHz
LQW15AN2N8D8Z□	—	2.8nH ±0.5nH	100MHz	27	250MHz	1500mA	0.047Ω	13.5GHz
LQW15AN2N8G8Z□	—	2.8nH ±2%	100MHz	27	250MHz	1500mA	0.047Ω	13.5GHz
LQW15AN2N9B8Z□	—	2.9nH ±0.1nH	100MHz	25	250MHz	1500mA	0.047Ω	12.5GHz
LQW15AN2N9C8Z□	—	2.9nH ±0.2nH	100MHz	25	250MHz	1500mA	0.047Ω	12.5GHz
LQW15AN2N9D8Z□	—	2.9nH ±0.5nH	100MHz	25	250MHz	1500mA	0.047Ω	12.5GHz
LQW15AN2N9G8Z□	—	2.9nH ±2%	100MHz	25	250MHz	1500mA	0.047Ω	12.5GHz
LQW15AN3N0B8Z□	—	3nH ±0.1nH	100MHz	20	250MHz	1350mA	0.063Ω	12.5GHz
LQW15AN3N0C8Z□	—	3nH ±0.2nH	100MHz	20	250MHz	1350mA	0.063Ω	12.5GHz
LQW15AN3N0D8Z□	—	3nH ±0.5nH	100MHz	20	250MHz	1350mA	0.063Ω	12.5GHz
LQW15AN3N0G8Z□	—	3nH ±2%	100MHz	20	250MHz	1350mA	0.063Ω	12.5GHz
LQW15AN3N3B8Z□	—	3.3nH ±0.1nH	100MHz	30	250MHz	2000mA	0.03Ω	14GHz
LQW15AN3N3C8Z□	—	3.3nH ±0.2nH	100MHz	30	250MHz	2000mA	0.03Ω	14GHz
LQW15AN3N3D8Z□	—	3.3nH ±0.5nH	100MHz	30	250MHz	2000mA	0.03Ω	14GHz
LQW15AN3N3G8Z□	—	3.3nH ±2%	100MHz	30	250MHz	2000mA	0.03Ω	14GHz
LQW15AN3N4B8Z□	—	3.4nH ±0.1nH	100MHz	30	250MHz	1950mA	0.03Ω	10GHz
LQW15AN3N4C8Z□	—	3.4nH ±0.2nH	100MHz	30	250MHz	1950mA	0.03Ω	10GHz
LQW15AN3N4D8Z□	—	3.4nH ±0.5nH	100MHz	30	250MHz	1950mA	0.03Ω	10GHz
LQW15AN3N4G8Z□	—	3.4nH ±2%	100MHz	30	250MHz	1950mA	0.03Ω	10GHz
LQW15AN3N5B8Z□	—	3.5nH ±0.1nH	100MHz	30	250MHz	1950mA	0.03Ω	10GHz
LQW15AN3N5C8Z□	—	3.5nH ±0.2nH	100MHz	30	250MHz	1950mA	0.03Ω	10GHz
LQW15AN3N5D8Z□	—	3.5nH ±0.5nH	100MHz	30	250MHz	1950mA	0.03Ω	10GHz
LQW15AN3N5G8Z□	—	3.5nH ±2%	100MHz	30	250MHz	1950mA	0.03Ω	10GHz
LQW15AN3N6B8Z□	—	3.6nH ±0.1nH	100MHz	30	250MHz	1950mA	0.03Ω	10GHz
LQW15AN3N6C8Z□	—	3.6nH ±0.2nH	100MHz	30	250MHz	1950mA	0.03Ω	10GHz
LQW15AN3N6D8Z□	—	3.6nH ±0.5nH	100MHz	30	250MHz	1950mA	0.03Ω	10GHz
LQW15AN3N6G8Z□	—	3.6nH ±2%	100MHz	30	250MHz	1950mA	0.03Ω	10GHz
LQW15AN3N7B8Z□	—	3.7nH ±0.1nH	100MHz	35	250MHz	1950mA	0.03Ω	10GHz
LQW15AN3N7C8Z□	—	3.7nH ±0.2nH	100MHz	35	250MHz	1950mA	0.03Ω	10GHz
LQW15AN3N7D8Z□	—	3.7nH ±0.5nH	100MHz	35	250MHz	1950mA	0.03Ω	10GHz
LQW15AN3N7G8Z□	—	3.7nH ±2%	100MHz	35	250MHz	1950mA	0.03Ω	10GHz
LQW15AN3N8B8Z□	—	3.8nH ±0.1nH	100MHz	35	250MHz	1950mA	0.03Ω	10GHz
LQW15AN3N8C8Z□	—	3.8nH ±0.2nH	100MHz	35	250MHz	1950mA	0.03Ω	10GHz
LQW15AN3N8D8Z□	—	3.8nH ±0.5nH	100MHz	35	250MHz	1950mA	0.03Ω	10GHz
LQW15AN3N8G8Z□	—	3.8nH ±2%	100MHz	35	250MHz	1950mA	0.03Ω	10GHz
LQW15AN3N9B8Z□	—	3.9nH ±0.1nH	100MHz	35	250MHz	1950mA	0.03Ω	10GHz
LQW15AN3N9C8Z□	—	3.9nH ±0.2nH	100MHz	35	250MHz	1950mA	0.03Ω	10GHz
LQW15AN3N9D8Z□	—	3.9nH ±0.5nH	100MHz	35	250MHz	1950mA	0.03Ω	10GHz
LQW15AN3N9G8Z□	—	3.9nH ±2%	100MHz	35	250MHz	1950mA	0.03Ω	10GHz
LQW15AN4N0B8Z□	—	4nH ±0.1nH	100MHz	30	250MHz	1950mA	0.03Ω	10GHz
LQW15AN4N0C8Z□	—	4nH ±0.2nH	100MHz	30	250MHz	1950mA	0.03Ω	10GHz
LQW15AN4N0D8Z□	—	4nH ±0.5nH	100MHz	30	250MHz	1950mA	0.03Ω	10GHz
LQW15AN4N0G8Z□	—	4nH ±2%	100MHz	30	250MHz	1950mA	0.03Ω	10GHz
LQW15AN4N1B8Z□	—	4.1nH ±0.1nH	100MHz	30	250MHz	1800mA	0.044Ω	9.6GHz
LQW15AN4N1C8Z□	—	4.1nH ±0.2nH	100MHz	30	250MHz	1800mA	0.044Ω	9.6GHz
LQW15AN4N1D8Z□	—	4.1nH ±0.5nH	100MHz	30	250MHz	1800mA	0.044Ω	9.6GHz
LQW15AN4N1G8Z□	—	4.1nH ±2%	100MHz	30	250MHz	1800mA	0.044Ω	9.6GHz
LQW15AN4N2B8Z□	—	4.2nH ±0.1nH	100MHz	30	250MHz	1800mA	0.044Ω	9.6GHz

Operating temp.range (Self-temp.rise not included): -55 to 125°C

Only for reflow soldering

\*S.R.F.: Self Resonant Frequency

Continued on the following page. ↗

Continued from the preceding page. ↘

Part Number		Inductance	Inductance Test Frequency	Q (min.)	Q Test Frequency	Rated Current	Max. of DC Resistance	S.R.F.* (min.)
Infotainment	Powertrain/Safety							
LQW15AN4N2C8Z□	—	4.2nH ±0.2nH	100MHz	30	250MHz	1800mA	0.044Ω	9.6GHz
LQW15AN4N2D8Z□	—	4.2nH ±0.5nH	100MHz	30	250MHz	1800mA	0.044Ω	9.6GHz
LQW15AN4N2G8Z□	—	4.2nH ±2%	100MHz	30	250MHz	1800mA	0.044Ω	9.6GHz
LQW15AN4N3B8Z□	—	4.3nH ±0.1nH	100MHz	32	250MHz	1800mA	0.044Ω	9.6GHz
LQW15AN4N3C8Z□	—	4.3nH ±0.2nH	100MHz	32	250MHz	1800mA	0.044Ω	9.6GHz
LQW15AN4N3D8Z□	—	4.3nH ±0.5nH	100MHz	32	250MHz	1800mA	0.044Ω	9.6GHz
LQW15AN4N3G8Z□	—	4.3nH ±2%	100MHz	32	250MHz	1800mA	0.044Ω	9.6GHz
LQW15AN4N4B8Z□	—	4.4nH ±0.1nH	100MHz	34	250MHz	1600mA	0.052Ω	9.6GHz
LQW15AN4N4C8Z□	—	4.4nH ±0.2nH	100MHz	34	250MHz	1600mA	0.052Ω	9.6GHz
LQW15AN4N4D8Z□	—	4.4nH ±0.5nH	100MHz	34	250MHz	1600mA	0.052Ω	9.6GHz
LQW15AN4N4G8Z□	—	4.4nH ±2%	100MHz	34	250MHz	1600mA	0.052Ω	9.6GHz
LQW15AN4N5B8Z□	—	4.5nH ±0.1nH	100MHz	34	250MHz	1450mA	0.06Ω	9.6GHz
LQW15AN4N5C8Z□	—	4.5nH ±0.2nH	100MHz	34	250MHz	1450mA	0.06Ω	9.6GHz
LQW15AN4N5D8Z□	—	4.5nH ±0.5nH	100MHz	34	250MHz	1450mA	0.06Ω	9.6GHz
LQW15AN4N5G8Z□	—	4.5nH ±2%	100MHz	34	250MHz	1450mA	0.06Ω	9.6GHz
LQW15AN4N6B8Z□	—	4.6nH ±0.1nH	100MHz	32	250MHz	1450mA	0.06Ω	9.6GHz
LQW15AN4N6C8Z□	—	4.6nH ±0.2nH	100MHz	32	250MHz	1450mA	0.06Ω	9.6GHz
LQW15AN4N6D8Z□	—	4.6nH ±0.5nH	100MHz	32	250MHz	1450mA	0.06Ω	9.6GHz
LQW15AN4N6G8Z□	—	4.6nH ±2%	100MHz	32	250MHz	1450mA	0.06Ω	9.6GHz
LQW15AN4N7B8Z□	—	4.7nH ±0.1nH	100MHz	31	250MHz	1200mA	0.071Ω	8GHz
LQW15AN4N7C8Z□	—	4.7nH ±0.2nH	100MHz	31	250MHz	1200mA	0.071Ω	8GHz
LQW15AN4N7D8Z□	—	4.7nH ±0.5nH	100MHz	31	250MHz	1200mA	0.071Ω	8GHz
LQW15AN4N7G8Z□	—	4.7nH ±2%	100MHz	31	250MHz	1200mA	0.071Ω	8GHz
LQW15AN4N8B8Z□	—	4.8nH ±0.1nH	100MHz	30	250MHz	1200mA	0.071Ω	8GHz
LQW15AN4N8C8Z□	—	4.8nH ±0.2nH	100MHz	30	250MHz	1200mA	0.071Ω	8GHz
LQW15AN4N8D8Z□	—	4.8nH ±0.5nH	100MHz	30	250MHz	1200mA	0.071Ω	8GHz
LQW15AN4N8G8Z□	—	4.8nH ±2%	100MHz	30	250MHz	1200mA	0.071Ω	8GHz
LQW15AN4N9B8Z□	—	4.9nH ±0.1nH	100MHz	27	250MHz	1200mA	0.071Ω	8GHz
LQW15AN4N9C8Z□	—	4.9nH ±0.2nH	100MHz	27	250MHz	1200mA	0.071Ω	8GHz
LQW15AN4N9D8Z□	—	4.9nH ±0.5nH	100MHz	27	250MHz	1200mA	0.071Ω	8GHz
LQW15AN4N9G8Z□	—	4.9nH ±2%	100MHz	27	250MHz	1200mA	0.071Ω	8GHz
LQW15AN5N0B8Z□	—	5nH ±0.1nH	100MHz	32	250MHz	1770mA	0.04Ω	10GHz
LQW15AN5N0C8Z□	—	5nH ±0.2nH	100MHz	32	250MHz	1770mA	0.04Ω	10GHz
LQW15AN5N0D8Z□	—	5nH ±0.5nH	100MHz	32	250MHz	1770mA	0.04Ω	10GHz
LQW15AN5N0G8Z□	—	5nH ±2%	100MHz	32	250MHz	1770mA	0.04Ω	10GHz
LQW15AN5N1B8Z□	—	5.1nH ±0.1nH	100MHz	35	250MHz	1770mA	0.04Ω	8GHz
LQW15AN5N1C8Z□	—	5.1nH ±0.2nH	100MHz	35	250MHz	1770mA	0.04Ω	8GHz
LQW15AN5N1D8Z□	—	5.1nH ±0.5nH	100MHz	35	250MHz	1770mA	0.04Ω	8GHz
LQW15AN5N1G8Z□	—	5.1nH ±2%	100MHz	35	250MHz	1770mA	0.04Ω	8GHz
LQW15AN5N2B8Z□	—	5.2nH ±0.1nH	100MHz	35	250MHz	1770mA	0.04Ω	8GHz
LQW15AN5N2C8Z□	—	5.2nH ±0.2nH	100MHz	35	250MHz	1770mA	0.04Ω	8GHz
LQW15AN5N2D8Z□	—	5.2nH ±0.5nH	100MHz	35	250MHz	1770mA	0.04Ω	8GHz
LQW15AN5N2G8Z□	—	5.2nH ±2%	100MHz	35	250MHz	1770mA	0.04Ω	8GHz
LQW15AN5N3B8Z□	—	5.3nH ±0.1nH	100MHz	35	250MHz	1770mA	0.04Ω	8GHz
LQW15AN5N3C8Z□	—	5.3nH ±0.2nH	100MHz	35	250MHz	1770mA	0.04Ω	8GHz
LQW15AN5N3D8Z□	—	5.3nH ±0.5nH	100MHz	35	250MHz	1770mA	0.04Ω	8GHz
LQW15AN5N3G8Z□	—	5.3nH ±2%	100MHz	35	250MHz	1770mA	0.04Ω	8GHz
LQW15AN5N4B8Z□	—	5.4nH ±0.1nH	100MHz	35	250MHz	1770mA	0.04Ω	8GHz
LQW15AN5N4C8Z□	—	5.4nH ±0.2nH	100MHz	35	250MHz	1770mA	0.04Ω	8GHz
LQW15AN5N4D8Z□	—	5.4nH ±0.5nH	100MHz	35	250MHz	1770mA	0.04Ω	8GHz
LQW15AN5N4G8Z□	—	5.4nH ±2%	100MHz	35	250MHz	1770mA	0.04Ω	8GHz
LQW15AN5N5B8Z□	—	5.5nH ±0.1nH	100MHz	35	250MHz	1770mA	0.04Ω	8GHz
LQW15AN5N5C8Z□	—	5.5nH ±0.2nH	100MHz	35	250MHz	1770mA	0.04Ω	8GHz

Operating temp.range (Self-temp.rise not included): -55 to 125°C

Only for reflow soldering

\*S.R.F.: Self Resonant Frequency

Continued on the following page. ↗



Continued from the preceding page. ↘

Part Number		Inductance	Inductance Test Frequency	Q (min.)	Q Test Frequency	Rated Current	Max. of DC Resistance	S.R.F* (min.)
Infotainment	Powertrain/Safety							
LQW15AN5N5D8Z□	—	5.5nH ±0.5nH	100MHz	35	250MHz	1770mA	0.04Ω	8GHz
LQW15AN5N5G8Z□	—	5.5nH ±2%	100MHz	35	250MHz	1770mA	0.04Ω	8GHz
LQW15AN5N6B8Z□	—	5.6nH ±0.1nH	100MHz	35	250MHz	1770mA	0.04Ω	8GHz
LQW15AN5N6C8Z□	—	5.6nH ±0.2nH	100MHz	35	250MHz	1770mA	0.04Ω	8GHz
LQW15AN5N6D8Z□	—	5.6nH ±0.5nH	100MHz	35	250MHz	1770mA	0.04Ω	8GHz
LQW15AN5N6G8Z□	—	5.6nH ±2%	100MHz	35	250MHz	1770mA	0.04Ω	8GHz
LQW15AN5N7B8Z□	—	5.7nH ±0.1nH	100MHz	30	250MHz	1770mA	0.04Ω	8GHz
LQW15AN5N7C8Z□	—	5.7nH ±0.2nH	100MHz	30	250MHz	1770mA	0.04Ω	8GHz
LQW15AN5N7D8Z□	—	5.7nH ±0.5nH	100MHz	30	250MHz	1770mA	0.04Ω	8GHz
LQW15AN5N7G8Z□	—	5.7nH ±2%	100MHz	30	250MHz	1770mA	0.04Ω	8GHz
LQW15AN5N8B8Z□	—	5.8nH ±0.1nH	100MHz	30	250MHz	1770mA	0.04Ω	8GHz
LQW15AN5N8C8Z□	—	5.8nH ±0.2nH	100MHz	30	250MHz	1770mA	0.04Ω	8GHz
LQW15AN5N8D8Z□	—	5.8nH ±0.5nH	100MHz	30	250MHz	1770mA	0.04Ω	8GHz
LQW15AN5N8G8Z□	—	5.8nH ±2%	100MHz	30	250MHz	1770mA	0.04Ω	8GHz
LQW15AN5N9B8Z□	—	5.9nH ±0.1nH	100MHz	30	250MHz	1770mA	0.04Ω	8GHz
LQW15AN5N9C8Z□	—	5.9nH ±0.2nH	100MHz	30	250MHz	1770mA	0.04Ω	8GHz
LQW15AN5N9D8Z□	—	5.9nH ±0.5nH	100MHz	30	250MHz	1770mA	0.04Ω	8GHz
LQW15AN5N9G8Z□	—	5.9nH ±2%	100MHz	30	250MHz	1770mA	0.04Ω	8GHz
LQW15AN6N0B8Z□	—	6nH ±0.1nH	100MHz	32	250MHz	1600mA	0.056Ω	8GHz
LQW15AN6N0C8Z□	—	6nH ±0.2nH	100MHz	32	250MHz	1600mA	0.056Ω	8GHz
LQW15AN6N0D8Z□	—	6nH ±0.5nH	100MHz	32	250MHz	1600mA	0.056Ω	8GHz
LQW15AN6N0G8Z□	—	6nH ±2%	100MHz	32	250MHz	1600mA	0.056Ω	8GHz
LQW15AN6N1B8Z□	—	6.1nH ±0.1nH	100MHz	32	250MHz	1600mA	0.056Ω	8GHz
LQW15AN6N1C8Z□	—	6.1nH ±0.2nH	100MHz	32	250MHz	1600mA	0.056Ω	8GHz
LQW15AN6N1D8Z□	—	6.1nH ±0.5nH	100MHz	32	250MHz	1600mA	0.056Ω	8GHz
LQW15AN6N1G8Z□	—	6.1nH ±2%	100MHz	32	250MHz	1600mA	0.056Ω	8GHz
LQW15AN6N2B8Z□	—	6.2nH ±0.1nH	100MHz	33	250MHz	1600mA	0.056Ω	8GHz
LQW15AN6N2C8Z□	—	6.2nH ±0.2nH	100MHz	33	250MHz	1600mA	0.056Ω	8GHz
LQW15AN6N2D8Z□	—	6.2nH ±0.5nH	100MHz	33	250MHz	1600mA	0.056Ω	8GHz
LQW15AN6N2G8Z□	—	6.2nH ±2%	100MHz	33	250MHz	1600mA	0.056Ω	8GHz
LQW15AN6N3G8Z□	—	6.3nH ±2%	100MHz	32	250MHz	1600mA	0.057Ω	7.8GHz
LQW15AN6N3J8Z□	—	6.3nH ±5%	100MHz	32	250MHz	1600mA	0.057Ω	7.8GHz
LQW15AN6N4G8Z□	—	6.4nH ±2%	100MHz	33	250MHz	1380mA	0.065Ω	7GHz
LQW15AN6N4J8Z□	—	6.4nH ±5%	100MHz	33	250MHz	1380mA	0.065Ω	7GHz
LQW15AN6N5G8Z□	—	6.5nH ±2%	100MHz	32	250MHz	1380mA	0.065Ω	7GHz
LQW15AN6N5J8Z□	—	6.5nH ±5%	100MHz	32	250MHz	1380mA	0.065Ω	7GHz
LQW15AN6N6G8Z□	—	6.6nH ±2%	100MHz	30	250MHz	1280mA	0.078Ω	7GHz
LQW15AN6N6J8Z□	—	6.6nH ±5%	100MHz	30	250MHz	1280mA	0.078Ω	7GHz
LQW15AN6N7G8Z□	—	6.7nH ±2%	100MHz	30	250MHz	1280mA	0.078Ω	7GHz
LQW15AN6N7J8Z□	—	6.7nH ±5%	100MHz	30	250MHz	1280mA	0.078Ω	7GHz
LQW15AN6N8G8Z□	—	6.8nH ±2%	100MHz	30	250MHz	1450mA	0.068Ω	7GHz
LQW15AN6N8J8Z□	—	6.8nH ±5%	100MHz	30	250MHz	1450mA	0.068Ω	7GHz
LQW15AN6N9G8Z□	—	6.9nH ±2%	100MHz	32	250MHz	1420mA	0.069Ω	8.5GHz
LQW15AN6N9J8Z□	—	6.9nH ±5%	100MHz	32	250MHz	1420mA	0.069Ω	8.5GHz
LQW15AN7N0G8Z□	—	7nH ±2%	100MHz	33	250MHz	1420mA	0.069Ω	8GHz
LQW15AN7N0J8Z□	—	7nH ±5%	100MHz	33	250MHz	1420mA	0.069Ω	8GHz
LQW15AN7N1G8Z□	—	7.1nH ±2%	100MHz	32	250MHz	1420mA	0.069Ω	7GHz
LQW15AN7N1J8Z□	—	7.1nH ±5%	100MHz	32	250MHz	1420mA	0.069Ω	7GHz
LQW15AN7N2G8Z□	—	7.2nH ±2%	100MHz	32	250MHz	1700mA	0.05Ω	7GHz
LQW15AN7N2J8Z□	—	7.2nH ±5%	100MHz	32	250MHz	1700mA	0.05Ω	7GHz
LQW15AN7N3G8Z□	—	7.3nH ±2%	100MHz	32	250MHz	1700mA	0.05Ω	7GHz
LQW15AN7N3J8Z□	—	7.3nH ±5%	100MHz	32	250MHz	1700mA	0.05Ω	7GHz
LQW15AN7N4G8Z□	—	7.4nH ±2%	100MHz	30	250MHz	1700mA	0.05Ω	7GHz

Operating temp.range (Self-temp.rise not included): -55 to 125°C

Only for reflow soldering

\*S.R.F: Self Resonant Frequency

Chip Ferrite Bead

Chip EMIFIL

Chip Common Mode Choke Coil

Block Type EMIFIL

Microchip Transformer (Ballun)

Inductors for Power Lines

Inductors for General Circuits

RF Inductors

Continued from the preceding page. ↘

Part Number		Inductance	Inductance Test Frequency	Q (min.)	Q Test Frequency	Rated Current	Max. of DC Resistance	S.R.F* (min.)
Infotainment	Powertrain/Safety							
LQW15AN7N4J8Z□	—	7.4nH ±5%	100MHz	30	250MHz	1700mA	0.05Ω	7GHz
LQW15AN7N5G8Z□	—	7.5nH ±2%	100MHz	35	250MHz	1700mA	0.05Ω	7GHz
LQW15AN7N5J8Z□	—	7.5nH ±5%	100MHz	35	250MHz	1700mA	0.05Ω	7GHz
LQW15AN7N6G8Z□	—	7.6nH ±2%	100MHz	30	250MHz	1700mA	0.05Ω	7GHz
LQW15AN7N6J8Z□	—	7.6nH ±5%	100MHz	30	250MHz	1700mA	0.05Ω	7GHz
LQW15AN7N7G8Z□	—	7.7nH ±2%	100MHz	30	250MHz	1700mA	0.05Ω	7GHz
LQW15AN7N7J8Z□	—	7.7nH ±5%	100MHz	30	250MHz	1700mA	0.05Ω	7GHz
LQW15AN7N8G8Z□	—	7.8nH ±2%	100MHz	30	250MHz	1700mA	0.05Ω	7GHz
LQW15AN7N8J8Z□	—	7.8nH ±5%	100MHz	30	250MHz	1700mA	0.05Ω	7GHz
LQW15AN7N9G8Z□	—	7.9nH ±2%	100MHz	30	250MHz	1700mA	0.05Ω	7GHz
LQW15AN7N9J8Z□	—	7.9nH ±5%	100MHz	30	250MHz	1700mA	0.05Ω	7GHz
LQW15AN8N0G8Z□	—	8nH ±2%	100MHz	30	250MHz	1700mA	0.05Ω	7GHz
LQW15AN8N0J8Z□	—	8nH ±5%	100MHz	30	250MHz	1700mA	0.05Ω	7GHz
LQW15AN8N1G8Z□	—	8.1nH ±2%	100MHz	32	250MHz	1500mA	0.069Ω	6.5GHz
LQW15AN8N1J8Z□	—	8.1nH ±5%	100MHz	32	250MHz	1500mA	0.069Ω	6.5GHz
LQW15AN8N2G8Z□	—	8.2nH ±2%	100MHz	32	250MHz	1500mA	0.069Ω	6.5GHz
LQW15AN8N2J8Z□	—	8.2nH ±5%	100MHz	32	250MHz	1500mA	0.069Ω	6.5GHz
LQW15AN8N3G8Z□	—	8.3nH ±2%	100MHz	32	250MHz	1500mA	0.069Ω	6.5GHz
LQW15AN8N3J8Z□	—	8.3nH ±5%	100MHz	32	250MHz	1500mA	0.069Ω	6.5GHz
LQW15AN8N4G8Z□	—	8.4nH ±2%	100MHz	32	250MHz	1500mA	0.069Ω	6.5GHz
LQW15AN8N4J8Z□	—	8.4nH ±5%	100MHz	32	250MHz	1500mA	0.069Ω	6.5GHz
LQW15AN8N5G8Z□	—	8.5nH ±2%	100MHz	32	250MHz	1500mA	0.069Ω	6.5GHz
LQW15AN8N5J8Z□	—	8.5nH ±5%	100MHz	32	250MHz	1500mA	0.069Ω	6.5GHz
LQW15AN8N6G8Z□	—	8.6nH ±2%	100MHz	31	250MHz	1420mA	0.07Ω	6.5GHz
LQW15AN8N6J8Z□	—	8.6nH ±5%	100MHz	31	250MHz	1420mA	0.07Ω	6.5GHz
LQW15AN8N7G8Z□	—	8.7nH ±2%	100MHz	31	250MHz	1420mA	0.07Ω	6.5GHz
LQW15AN8N7J8Z□	—	8.7nH ±5%	100MHz	31	250MHz	1420mA	0.07Ω	6.5GHz
LQW15AN8N8G8Z□	—	8.8nH ±2%	100MHz	31	250MHz	1420mA	0.07Ω	6.5GHz
LQW15AN8N8J8Z□	—	8.8nH ±5%	100MHz	31	250MHz	1420mA	0.07Ω	6.5GHz
LQW15AN8N9G8Z□	—	8.9nH ±2%	100MHz	31	250MHz	1420mA	0.07Ω	6.5GHz
LQW15AN8N9J8Z□	—	8.9nH ±5%	100MHz	31	250MHz	1420mA	0.07Ω	6.5GHz
LQW15AN9N0G8Z□	—	9nH ±2%	100MHz	30	250MHz	1420mA	0.07Ω	6.5GHz
LQW15AN9N0J8Z□	—	9nH ±5%	100MHz	30	250MHz	1420mA	0.07Ω	6.5GHz
LQW15AN9N1G8Z□	—	9.1nH ±2%	100MHz	32	250MHz	1400mA	0.08Ω	6.5GHz
LQW15AN9N1J8Z□	—	9.1nH ±5%	100MHz	32	250MHz	1400mA	0.08Ω	6.5GHz
LQW15AN9N2G8Z□	—	9.2nH ±2%	100MHz	32	250MHz	1400mA	0.081Ω	6GHz
LQW15AN9N2J8Z□	—	9.2nH ±5%	100MHz	32	250MHz	1400mA	0.081Ω	6GHz
LQW15AN9N3G8Z□	—	9.3nH ±2%	100MHz	34	250MHz	1400mA	0.081Ω	6GHz
LQW15AN9N3J8Z□	—	9.3nH ±5%	100MHz	34	250MHz	1400mA	0.081Ω	6GHz
LQW15AN9N4G8Z□	—	9.4nH ±2%	100MHz	33	250MHz	1400mA	0.081Ω	6GHz
LQW15AN9N4J8Z□	—	9.4nH ±5%	100MHz	33	250MHz	1400mA	0.081Ω	6GHz
LQW15AN9N5G8Z□	—	9.5nH ±2%	100MHz	32	250MHz	1400mA	0.081Ω	6GHz
LQW15AN9N5J8Z□	—	9.5nH ±5%	100MHz	32	250MHz	1400mA	0.081Ω	6GHz
LQW15AN9N6G8Z□	—	9.6nH ±2%	100MHz	33	250MHz	1400mA	0.081Ω	6GHz
LQW15AN9N6J8Z□	—	9.6nH ±5%	100MHz	33	250MHz	1400mA	0.081Ω	6GHz
LQW15AN9N7G8Z□	—	9.7nH ±2%	100MHz	33	250MHz	1400mA	0.081Ω	6GHz
LQW15AN9N7J8Z□	—	9.7nH ±5%	100MHz	33	250MHz	1400mA	0.081Ω	6GHz
LQW15AN9N8G8Z□	—	9.8nH ±2%	100MHz	34	250MHz	1400mA	0.081Ω	6GHz
LQW15AN9N8J8Z□	—	9.8nH ±5%	100MHz	34	250MHz	1400mA	0.081Ω	6GHz
LQW15AN9N9G8Z□	—	9.9nH ±2%	100MHz	32	250MHz	1400mA	0.081Ω	6GHz
LQW15AN9N9J8Z□	—	9.9nH ±5%	100MHz	32	250MHz	1400mA	0.081Ω	6GHz
LQW15AN10NG8Z□	—	10nH ±2%	100MHz	31	250MHz	1400mA	0.081Ω	6GHz
LQW15AN10NJ8Z□	—	10nH ±5%	100MHz	31	250MHz	1400mA	0.081Ω	6GHz

Operating temp.range (Self-temp.rise not included): -55 to 125°C

Only for reflow soldering

\*S.R.F: Self Resonant Frequency

Continued on the following page. ↗

Continued from the preceding page. ↘

Part Number		Inductance	Inductance Test Frequency	Q (min.)	Q Test Frequency	Rated Current	Max. of DC Resistance	S.R.F.* (min.)
Infotainment	Powertrain/Safety							
LQW15AN11NG8Z□	—	11nH ±2%	100MHz	32	250MHz	1400mA	0.083Ω	6.2GHz
LQW15AN11NJ8Z□	—	11nH ±5%	100MHz	32	250MHz	1400mA	0.083Ω	6.2GHz
LQW15AN12NG8Z□	—	12nH ±2%	100MHz	30	250MHz	1240mA	0.093Ω	5.2GHz
LQW15AN12NJ8Z□	—	12nH ±5%	100MHz	30	250MHz	1240mA	0.093Ω	5.2GHz
LQW15AN13NG8Z□	—	13nH ±2%	100MHz	30	250MHz	1240mA	0.093Ω	5.2GHz
LQW15AN13NJ8Z□	—	13nH ±5%	100MHz	30	250MHz	1240mA	0.093Ω	5.2GHz
LQW15AN14NG8Z□	—	14nH ±2%	100MHz	31	250MHz	1150mA	0.111Ω	5.2GHz
LQW15AN14NJ8Z□	—	14nH ±5%	100MHz	31	250MHz	1150mA	0.111Ω	5.2GHz
LQW15AN15NG8Z□	—	15nH ±2%	100MHz	31	250MHz	1150mA	0.114Ω	5.5GHz
LQW15AN15NJ8Z□	—	15nH ±5%	100MHz	31	250MHz	1150mA	0.114Ω	5.5GHz
LQW15AN16NG8Z□	—	16nH ±2%	100MHz	31	250MHz	1000mA	0.126Ω	5GHz
LQW15AN16NJ8Z□	—	16nH ±5%	100MHz	31	250MHz	1000mA	0.126Ω	5GHz
LQW15AN17NG8Z□	—	17nH ±2%	100MHz	30	250MHz	1000mA	0.126Ω	5GHz
LQW15AN17NJ8Z□	—	17nH ±5%	100MHz	30	250MHz	1000mA	0.126Ω	5GHz
LQW15AN18NG8Z□	—	18nH ±2%	100MHz	30	250MHz	1050mA	0.13Ω	5.2GHz
LQW15AN18NJ8Z□	—	18nH ±5%	100MHz	30	250MHz	1050mA	0.13Ω	5.2GHz
LQW15AN19NG8Z□	—	19nH ±2%	100MHz	30	250MHz	920mA	0.156Ω	5GHz
LQW15AN19NJ8Z□	—	19nH ±5%	100MHz	30	250MHz	920mA	0.156Ω	5GHz
LQW15AN20NG8Z□	—	20nH ±2%	100MHz	30	250MHz	800mA	0.186Ω	4.5GHz
LQW15AN20NJ8Z□	—	20nH ±5%	100MHz	30	250MHz	800mA	0.186Ω	4.5GHz
LQW15AN21NG8Z□	—	21nH ±2%	100MHz	30	250MHz	780mA	0.202Ω	4.5GHz
LQW15AN21NJ8Z□	—	21nH ±5%	100MHz	30	250MHz	780mA	0.202Ω	4.5GHz
LQW15AN22NG8Z□	—	22nH ±2%	100MHz	30	250MHz	780mA	0.202Ω	4.5GHz
LQW15AN22NJ8Z□	—	22nH ±5%	100MHz	30	250MHz	780mA	0.202Ω	4.5GHz
LQW15AN23NG8Z□	—	23nH ±2%	100MHz	29	250MHz	760mA	0.201Ω	4.5GHz
LQW15AN23NJ8Z□	—	23nH ±5%	100MHz	29	250MHz	760mA	0.201Ω	4.5GHz
LQW15AN24NG8Z□	—	24nH ±2%	100MHz	31	250MHz	770mA	0.212Ω	4GHz
LQW15AN24NJ8Z□	—	24nH ±5%	100MHz	31	250MHz	770mA	0.212Ω	4GHz
LQW15AN25NG8Z□	—	25nH ±2%	100MHz	31	250MHz	750mA	0.221Ω	4.1GHz
LQW15AN25NJ8Z□	—	25nH ±5%	100MHz	31	250MHz	750mA	0.221Ω	4.1GHz
LQW15AN26NG8Z□	—	26nH ±2%	100MHz	29	250MHz	720mA	0.282Ω	4.1GHz
LQW15AN26NJ8Z□	—	26nH ±5%	100MHz	29	250MHz	720mA	0.282Ω	4.1GHz
LQW15AN27NG8Z□	—	27nH ±2%	100MHz	30	250MHz	680mA	0.288Ω	4GHz
LQW15AN27NJ8Z□	—	27nH ±5%	100MHz	30	250MHz	680mA	0.288Ω	4GHz
LQW15AN30NG8Z□	—	30nH ±2%	100MHz	30	250MHz	660mA	0.309Ω	3.8GHz
LQW15AN30NJ8Z□	—	30nH ±5%	100MHz	30	250MHz	660mA	0.309Ω	3.8GHz
LQW15AN33NG8Z□	—	33nH ±2%	100MHz	30	250MHz	620mA	0.336Ω	3.6GHz
LQW15AN33NJ8Z□	—	33nH ±5%	100MHz	30	250MHz	620mA	0.336Ω	3.6GHz
LQW15AN36NG8Z□	—	36nH ±2%	100MHz	30	250MHz	540mA	0.431Ω	3.5GHz
LQW15AN36NJ8Z□	—	36nH ±5%	100MHz	30	250MHz	540mA	0.431Ω	3.5GHz
LQW15AN39NG8Z□	—	39nH ±2%	100MHz	28	250MHz	530mA	0.456Ω	3.4GHz
LQW15AN39NJ8Z□	—	39nH ±5%	100MHz	28	250MHz	530mA	0.456Ω	3.4GHz
LQW15AN43NG8Z□	—	43nH ±2%	100MHz	30	250MHz	515mA	0.516Ω	3.4GHz
LQW15AN43NJ8Z□	—	43nH ±5%	100MHz	30	250MHz	515mA	0.516Ω	3.4GHz
LQW15AN47NG8Z□	—	47nH ±2%	100MHz	25	200MHz	440mA	0.648Ω	3.2GHz
LQW15AN47NJ8Z□	—	47nH ±5%	100MHz	25	200MHz	440mA	0.648Ω	3.2GHz
LQW15AN51NG8Z□	—	51nH ±2%	100MHz	25	200MHz	415mA	0.696Ω	2.9GHz
LQW15AN51NJ8Z□	—	51nH ±5%	100MHz	25	200MHz	415mA	0.696Ω	2.9GHz
LQW15AN53NG8Z□	—	53nH ±2%	100MHz	25	200MHz	415mA	0.696Ω	2.9GHz
LQW15AN53NJ8Z□	—	53nH ±5%	100MHz	25	200MHz	415mA	0.696Ω	2.9GHz
LQW15AN56NG8Z□	—	56nH ±2%	100MHz	25	200MHz	340mA	0.996Ω	2.9GHz
LQW15AN56NJ8Z□	—	56nH ±5%	100MHz	25	200MHz	340mA	0.996Ω	2.9GHz
LQW15AN68NG8Z□	—	68nH ±2%	100MHz	25	200MHz	320mA	1.128Ω	2.5GHz

Operating temp.range (Self-temp.rise not included): -55 to 125°C

Only for reflow soldering

\*S.R.F.: Self Resonant Frequency

Continued on the following page. ↗



Continued from the preceding page. ↘

Part Number		Inductance	Inductance Test Frequency	Q (min.)	Q Test Frequency	Rated Current	Max. of DC Resistance	S.R.F.* (min.)
Infotainment	Powertrain/Safety							
LQW15AN68NJ8Z□	—	68nH ±5%	100MHz	25	200MHz	320mA	1.128Ω	2.5GHz
LQW15AN75NG8Z□	—	75nH ±2%	100MHz	25	200MHz	320mA	1.224Ω	2.4GHz
LQW15AN75NJ8Z□	—	75nH ±5%	100MHz	25	200MHz	320mA	1.224Ω	2.4GHz

Operating temp.range (Self-temp.rise not included): -55 to 125°C

Only for reflow soldering

\*S.R.F: Self Resonant Frequency

### Inductance-Frequency Characteristics (Typ.)

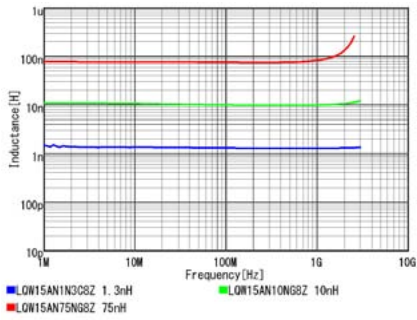

### Q-Frequency Characteristics (Typ.)

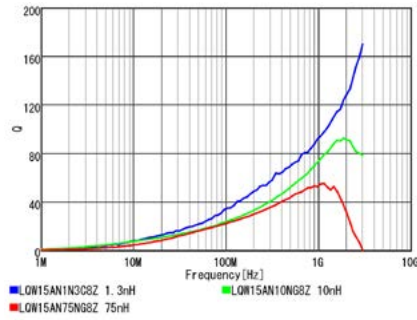

### Notice(Rating)

In operating temperatures exceeding +85°C, derating of current is necessary for this series.

Please apply the derating curve shown in the chart according to the operating temperature.

#### Derating of Rated Current

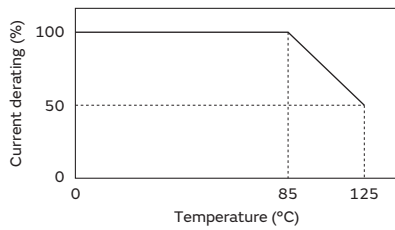

# RF Inductors

## LQW18AN\_0Z Series 0603 (1608) inch (mm)

### Specifications Sheet (with cautions/mounting/packaging)

Infotainment	<a href="https://search.murata.co.jp/Ceramy/image/img/P02/JELF243A-9116.pdf">https://search.murata.co.jp/Ceramy/image/img/P02/JELF243A-9116.pdf</a>
Powertrain/Safety	—

### Appearance/Dimensions

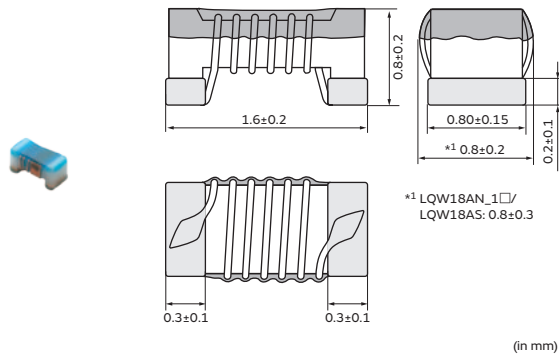

### Packaging

Code	Packaging	Minimum Quantity
D	ø180mm Paper Taping	4000
J	ø330mm Paper Taping	10000
B	Packing in Bulk	500

### Rated Value (□: packaging code)

Part Number		Inductance	Inductance Test Frequency	Q (min.)	Q Test Frequency	Rated Current	Max. of DC Resistance	S.R.F* (min.)
Infotainment	Powertrain/Safety							
LQW18AN2N2D0Z□	—	2.2nH ±0.5nH	100MHz	16	250MHz	700mA	0.042Ω	6000MHz
LQW18AN3N6C0Z□	—	3.6nH ±0.2nH	100MHz	25	250MHz	850mA	0.059Ω	6000MHz
LQW18AN3N6D0Z□	—	3.6nH ±0.5nH	100MHz	25	250MHz	850mA	0.059Ω	6000MHz
LQW18AN3N9C0Z□	—	3.9nH ±0.2nH	100MHz	35	250MHz	850mA	0.059Ω	6000MHz
LQW18AN3N9D0Z□	—	3.9nH ±0.5nH	100MHz	35	250MHz	850mA	0.059Ω	6000MHz
LQW18AN4N3C0Z□	—	4.3nH ±0.2nH	100MHz	35	250MHz	850mA	0.059Ω	6000MHz
LQW18AN4N3D0Z□	—	4.3nH ±0.5nH	100MHz	35	250MHz	850mA	0.059Ω	6000MHz
LQW18AN4N7D0Z□	—	4.7nH ±0.5nH	100MHz	35	250MHz	850mA	0.059Ω	6000MHz
LQW18AN5N6C0Z□	—	5.6nH ±0.2nH	100MHz	35	250MHz	750mA	0.082Ω	6000MHz
LQW18AN5N6D0Z□	—	5.6nH ±0.5nH	100MHz	35	250MHz	750mA	0.082Ω	6000MHz
LQW18AN6N2C0Z□	—	6.2nH ±0.2nH	100MHz	35	250MHz	750mA	0.082Ω	6000MHz
LQW18AN6N2D0Z□	—	6.2nH ±0.5nH	100MHz	35	250MHz	750mA	0.082Ω	6000MHz
LQW18AN6N8C0Z□	—	6.8nH ±0.2nH	100MHz	35	250MHz	750mA	0.082Ω	6000MHz
LQW18AN6N8D0Z□	—	6.8nH ±0.5nH	100MHz	35	250MHz	750mA	0.082Ω	6000MHz
LQW18AN7N5C0Z□	—	7.5nH ±0.2nH	100MHz	35	250MHz	750mA	0.082Ω	6000MHz
LQW18AN7N5D0Z□	—	7.5nH ±0.5nH	100MHz	35	250MHz	750mA	0.082Ω	6000MHz
LQW18AN8N2C0Z□	—	8.2nH ±0.2nH	100MHz	35	250MHz	650mA	0.11Ω	6000MHz
LQW18AN8N2D0Z□	—	8.2nH ±0.5nH	100MHz	35	250MHz	650mA	0.11Ω	6000MHz
LQW18AN8N7C0Z□	—	8.7nH ±0.2nH	100MHz	35	250MHz	650mA	0.11Ω	6000MHz
LQW18AN8N7D0Z□	—	8.7nH ±0.5nH	100MHz	35	250MHz	650mA	0.11Ω	6000MHz
LQW18AN9N1C0Z□	—	9.1nH ±0.2nH	100MHz	35	250MHz	650mA	0.11Ω	6000MHz
LQW18AN9N1D0Z□	—	9.1nH ±0.5nH	100MHz	35	250MHz	650mA	0.11Ω	6000MHz
LQW18AN9N5D0Z□	—	9.5nH ±0.5nH	100MHz	35	250MHz	650mA	0.11Ω	6000MHz
LQW18AN10NG0Z□	—	10nH ±2%	100MHz	35	250MHz	650mA	0.11Ω	6000MHz
LQW18AN10NJ0Z□	—	10nH ±5%	100MHz	35	250MHz	650mA	0.11Ω	6000MHz
LQW18AN11NG0Z□	—	11nH ±2%	100MHz	35	250MHz	650mA	0.11Ω	6000MHz
LQW18AN11NJ0Z□	—	11nH ±5%	100MHz	35	250MHz	650mA	0.11Ω	6000MHz
LQW18AN12NG0Z□	—	12nH ±2%	100MHz	35	250MHz	600mA	0.13Ω	6000MHz

Operating temp.range (Self-temp.rise not included): -55 to 125°C

Only for reflow soldering

\*S.R.F: Self Resonant Frequency

Continued on the following page. ↗

Chip Ferrite Bead  
Chip EMIFIL  
Chip Common Mode Choke Coil  
Block Type EMIFIL  
Microchip Transformer (Ballun)  
Inductors for Power Lines  
Inductors for General Circuits  
RF Inductors

Continued from the preceding page. ↘

Part Number		Inductance	Inductance Test Frequency	Q (min.)	Q Test Frequency	Rated Current	Max. of DC Resistance	S.R.F* (min.)
Infotainment	Powertrain/Safety							
LQW18AN12NJ0Z□	—	12nH ±5%	100MHz	35	250MHz	600mA	0.13Ω	6000MHz
LQW18AN13NG0Z□	—	13nH ±2%	100MHz	35	250MHz	600mA	0.13Ω	6000MHz
LQW18AN13NJ0Z□	—	13nH ±5%	100MHz	35	250MHz	600mA	0.13Ω	6000MHz
LQW18AN15NG0Z□	—	15nH ±2%	100MHz	40	250MHz	600mA	0.13Ω	6000MHz
LQW18AN15NJ0Z□	—	15nH ±5%	100MHz	40	250MHz	600mA	0.13Ω	6000MHz
LQW18AN16NG0Z□	—	16nH ±2%	100MHz	40	250MHz	550mA	0.16Ω	5500MHz
LQW18AN16NJ0Z□	—	16nH ±5%	100MHz	40	250MHz	550mA	0.16Ω	5500MHz
LQW18AN18NG0Z□	—	18nH ±2%	100MHz	40	250MHz	550mA	0.16Ω	5500MHz
LQW18AN18NJ0Z□	—	18nH ±5%	100MHz	40	250MHz	550mA	0.16Ω	5500MHz
LQW18AN20NG0Z□	—	20nH ±2%	100MHz	40	250MHz	550mA	0.16Ω	4900MHz
LQW18AN20NJ0Z□	—	20nH ±5%	100MHz	40	250MHz	550mA	0.16Ω	4900MHz
LQW18AN22NG0Z□	—	22nH ±2%	100MHz	40	250MHz	500mA	0.17Ω	4600MHz
LQW18AN22NJ0Z□	—	22nH ±5%	100MHz	40	250MHz	500mA	0.17Ω	4600MHz
LQW18AN24NG0Z□	—	24nH ±2%	100MHz	40	250MHz	500mA	0.21Ω	3800MHz
LQW18AN24NJ0Z□	—	24nH ±5%	100MHz	40	250MHz	500mA	0.21Ω	3800MHz
LQW18AN27NG0Z□	—	27nH ±2%	100MHz	40	250MHz	440mA	0.21Ω	3700MHz
LQW18AN27NJ0Z□	—	27nH ±5%	100MHz	40	250MHz	440mA	0.21Ω	3700MHz
LQW18AN30NG0Z□	—	30nH ±2%	100MHz	40	250MHz	420mA	0.23Ω	3300MHz
LQW18AN30NJ0Z□	—	30nH ±5%	100MHz	40	250MHz	420mA	0.23Ω	3300MHz
LQW18AN33NG0Z□	—	33nH ±2%	100MHz	40	250MHz	420mA	0.23Ω	3200MHz
LQW18AN33NJ0Z□	—	33nH ±5%	100MHz	40	250MHz	420mA	0.23Ω	3200MHz
LQW18AN36NG0Z□	—	36nH ±2%	100MHz	40	250MHz	400mA	0.26Ω	2900MHz
LQW18AN36NJ0Z□	—	36nH ±5%	100MHz	40	250MHz	400mA	0.26Ω	2900MHz
LQW18AN39NG0Z□	—	39nH ±2%	100MHz	40	250MHz	400mA	0.26Ω	2800MHz
LQW18AN39NJ0Z□	—	39nH ±5%	100MHz	40	250MHz	400mA	0.26Ω	2800MHz
LQW18AN43NG0Z□	—	43nH ±2%	100MHz	40	200MHz	380mA	0.29Ω	2700MHz
LQW18AN43NJ0Z□	—	43nH ±5%	100MHz	40	200MHz	380mA	0.29Ω	2700MHz
LQW18AN47NG0Z□	—	47nH ±2%	100MHz	38	200MHz	380mA	0.29Ω	2600MHz
LQW18AN47NJ0Z□	—	47nH ±5%	100MHz	38	200MHz	380mA	0.29Ω	2600MHz
LQW18AN51NG0Z□	—	51nH ±2%	100MHz	38	200MHz	370mA	0.33Ω	2500MHz
LQW18AN51NJ0Z□	—	51nH ±5%	100MHz	38	200MHz	370mA	0.33Ω	2500MHz
LQW18AN56NG0Z□	—	56nH ±2%	100MHz	38	200MHz	360mA	0.35Ω	2400MHz
LQW18AN56NJ0Z□	—	56nH ±5%	100MHz	38	200MHz	360mA	0.35Ω	2400MHz
LQW18AN62NG0Z□	—	62nH ±2%	100MHz	38	200MHz	280mA	0.51Ω	2300MHz
LQW18AN62NJ0Z□	—	62nH ±5%	100MHz	38	200MHz	280mA	0.51Ω	2300MHz
LQW18AN68NG0Z□	—	68nH ±2%	100MHz	38	200MHz	340mA	0.38Ω	2200MHz
LQW18AN68NJ0Z□	—	68nH ±5%	100MHz	38	200MHz	340mA	0.38Ω	2200MHz
LQW18AN72NG0Z□	—	72nH ±2%	100MHz	34	150MHz	270mA	0.56Ω	2100MHz
LQW18AN72NJ0Z□	—	72nH ±5%	100MHz	34	150MHz	270mA	0.56Ω	2100MHz
LQW18AN75NG0Z□	—	75nH ±2%	100MHz	34	150MHz	270mA	0.56Ω	2050MHz
LQW18AN75NJ0Z□	—	75nH ±5%	100MHz	34	150MHz	270mA	0.56Ω	2050MHz
LQW18AN82NG0Z□	—	82nH ±2%	100MHz	34	150MHz	250mA	0.6Ω	2000MHz
LQW18AN82NJ0Z□	—	82nH ±5%	100MHz	34	150MHz	250mA	0.6Ω	2000MHz
LQW18AN91NG0Z□	—	91nH ±2%	100MHz	34	150MHz	230mA	0.64Ω	1900MHz
LQW18AN91NJ0Z□	—	91nH ±5%	100MHz	34	150MHz	230mA	0.64Ω	1900MHz
LQW18ANR10G0Z□	—	100nH ±2%	100MHz	34	150MHz	220mA	0.68Ω	1800MHz
LQW18ANR10J0Z□	—	100nH ±5%	100MHz	34	150MHz	220mA	0.68Ω	1800MHz
LQW18ANR11G0Z□	—	110nH ±2%	100MHz	32	150MHz	200mA	1.2Ω	1700MHz
LQW18ANR11J0Z□	—	110nH ±5%	100MHz	32	150MHz	200mA	1.2Ω	1700MHz
LQW18ANR12G0Z□	—	120nH ±2%	100MHz	32	150MHz	180mA	1.3Ω	1600MHz
LQW18ANR12J0Z□	—	120nH ±5%	100MHz	32	150MHz	180mA	1.3Ω	1600MHz
LQW18ANR13G0Z□	—	130nH ±2%	100MHz	32	150MHz	170mA	1.4Ω	1450MHz
LQW18ANR13J0Z□	—	130nH ±5%	100MHz	32	150MHz	170mA	1.4Ω	1450MHz

Operating temp.range (Self-temp.rise not included): -55 to 125°C  
 Only for reflow soldering  
 \*S.R.F: Self Resonant Frequency

Continued on the following page. ↗

Continued from the preceding page. ↘

Part Number		Inductance	Inductance Test Frequency	Q (min.)	Q Test Frequency	Rated Current	Max. of DC Resistance	S.R.F.* (min.)
Infotainment	Powertrain/Safety							
LQW18ANR15G0Z□	—	150nH ±2%	100MHz	32	150MHz	160mA	1.5Ω	1400MHz
LQW18ANR15J0Z□	—	150nH ±5%	100MHz	32	150MHz	160mA	1.5Ω	1400MHz
LQW18ANR16G0Z□	—	160nH ±2%	100MHz	32	150MHz	150mA	2.1Ω	1350MHz
LQW18ANR16J0Z□	—	160nH ±5%	100MHz	32	150MHz	150mA	2.1Ω	1350MHz
LQW18ANR18G0Z□	—	180nH ±2%	100MHz	25	100MHz	140mA	2.2Ω	1300MHz
LQW18ANR18J0Z□	—	180nH ±5%	100MHz	25	100MHz	140mA	2.2Ω	1300MHz
LQW18ANR20G0Z□	—	200nH ±2%	100MHz	25	100MHz	120mA	2.4Ω	1250MHz
LQW18ANR20J0Z□	—	200nH ±5%	100MHz	25	100MHz	120mA	2.4Ω	1250MHz
LQW18ANR22G0Z□	—	220nH ±2%	100MHz	25	100MHz	120mA	2.5Ω	1200MHz
LQW18ANR22J0Z□	—	220nH ±5%	100MHz	25	100MHz	120mA	2.5Ω	1200MHz
LQW18ANR27G0Z□	—	270nH ±2%	100MHz	30	100MHz	110mA	3.4Ω	960MHz
LQW18ANR27J0Z□	—	270nH ±5%	100MHz	30	100MHz	110mA	3.4Ω	960MHz
LQW18ANR33G0Z□	—	330nH ±2%	100MHz	30	100MHz	85mA	5.5Ω	800MHz
LQW18ANR33J0Z□	—	330nH ±5%	100MHz	30	100MHz	85mA	5.5Ω	800MHz
LQW18ANR39G0Z□	—	390nH ±2%	100MHz	30	100MHz	80mA	6.2Ω	800MHz
LQW18ANR39J0Z□	—	390nH ±5%	100MHz	30	100MHz	80mA	6.2Ω	800MHz
LQW18ANR47G0Z□	—	470nH ±2%	100MHz	30	100MHz	75mA	7Ω	700MHz
LQW18ANR47J0Z□	—	470nH ±5%	100MHz	30	100MHz	75mA	7Ω	700MHz

Operating temp.range (Self-temp.rise not included): -55 to 125°C  
 Only for reflow soldering  
 \*S.R.F: Self Resonant Frequency

**Inductance-Frequency Characteristics (Typ.)**

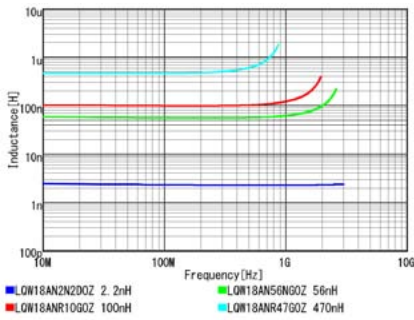

**Q-Frequency Characteristics (Typ.)**

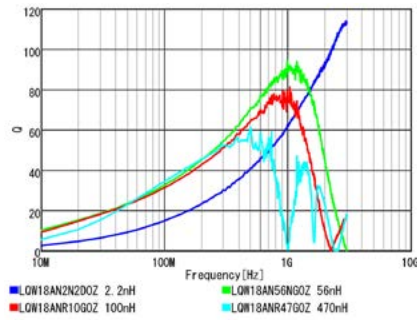

Chip Ferrite Bead

Chip EMIFIL

Chip Common Mode Choke Coil

Block Type EMIFIL

Microchip Transformer (Balun)

Inductors for Power Lines

Inductors for General Circuits

RF Inductors

# RF Inductors

## LQW18AN\_1Z Series 0603 (1608) inch (mm)

### Specifications Sheet (with cautions/mounting/packaging)

Infotainment	<a href="https://search.murata.co.jp/Ceramy/image/img/P02/JELF243A-9117.pdf">https://search.murata.co.jp/Ceramy/image/img/P02/JELF243A-9117.pdf</a>
Powertrain/Safety	—

### Appearance/Dimensions

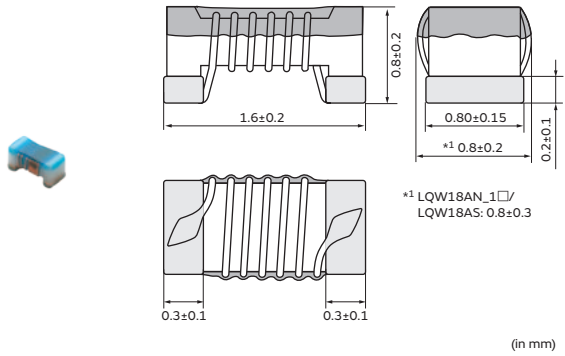

### Packaging

Code	Packaging	Minimum Quantity
D	ø180mm Paper Taping	4000
J	ø330mm Paper Taping	10000
B	Packing in Bulk	500

### Rated Value (□: packaging code)

Part Number		Inductance	Inductance Test Frequency	Q (min.)	Q Test Frequency	Rated Current	Max. of DC Resistance	S.R.F.* (min.)
Infotainment	Powertrain/Safety							
LQW18AN2N2D1Z□	—	2.2nH ±0.5nH	100MHz	25	250MHz	1400mA	0.018Ω	18000MHz
LQW18AN3N9C1Z□	—	3.9nH ±0.2nH	100MHz	38	250MHz	1000mA	0.032Ω	11000MHz
LQW18AN3N9D1Z□	—	3.9nH ±0.5nH	100MHz	38	250MHz	1000mA	0.032Ω	11000MHz
LQW18AN5N6D1Z□	—	5.6nH ±0.5nH	100MHz	38	250MHz	900mA	0.045Ω	10000MHz
LQW18AN6N8C1Z□	—	6.8nH ±0.2nH	100MHz	38	250MHz	900mA	0.045Ω	7000MHz
LQW18AN6N8D1Z□	—	6.8nH ±0.5nH	100MHz	38	250MHz	900mA	0.045Ω	7000MHz
LQW18AN8N2D1Z□	—	8.2nH ±0.5nH	100MHz	38	250MHz	800mA	0.058Ω	7000MHz
LQW18AN10NG1Z□	—	10nH ±2%	100MHz	38	250MHz	800mA	0.058Ω	5000MHz
LQW18AN10NJ1Z□	—	10nH ±5%	100MHz	38	250MHz	800mA	0.058Ω	5000MHz
LQW18AN12NG1Z□	—	12nH ±2%	100MHz	38	250MHz	750mA	0.071Ω	5000MHz
LQW18AN12NJ1Z□	—	12nH ±5%	100MHz	38	250MHz	750mA	0.071Ω	5000MHz
LQW18AN15NJ1Z□	—	15nH ±5%	100MHz	42	250MHz	700mA	0.085Ω	4500MHz
LQW18AN18NG1Z□	—	18nH ±2%	100MHz	42	250MHz	700mA	0.085Ω	3500MHz
LQW18AN18NJ1Z□	—	18nH ±5%	100MHz	42	250MHz	700mA	0.085Ω	3500MHz
LQW18AN22NG1Z□	—	22nH ±2%	100MHz	42	250MHz	640mA	0.099Ω	3200MHz
LQW18AN22NJ1Z□	—	22nH ±5%	100MHz	42	250MHz	640mA	0.099Ω	3200MHz
LQW18AN27NG1Z□	—	27nH ±2%	100MHz	42	250MHz	590mA	0.116Ω	2800MHz
LQW18AN27NJ1Z□	—	27nH ±5%	100MHz	42	250MHz	590mA	0.116Ω	2800MHz
LQW18AN33NJ1Z□	—	33nH ±5%	100MHz	42	250MHz	550mA	0.132Ω	2500MHz

Operating temp.range (Self-temp.rise not included): -55 to 125°C

Only for reflow soldering

\*S.R.F: Self Resonant Frequency

Continued on the following page. ↗

Continued from the preceding page. ↘

### Inductance-Frequency Characteristics (Typ.)

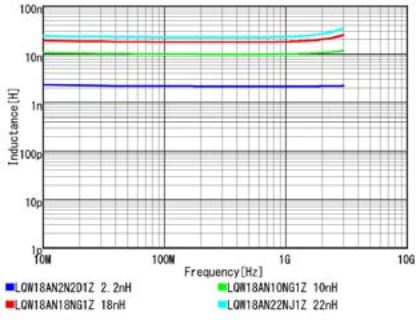

### Q-Frequency Characteristics (Typ.)

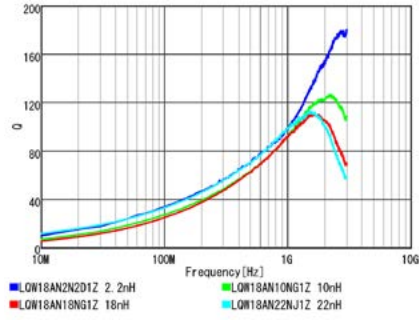

Chip Ferrite Bead

Chip EMIFIL

Chip Common Mode Choke Coil

Block Type EMIFIL

Microchip Transformer (Balun)

Inductors for Power Lines

Inductors for General Circuits

RF Inductors

# RF Inductors

## LQW18AN\_8Z Series 0603 (1608) inch (mm)

### Specifications Sheet (with cautions/mounting/packaging)

Infotainment	<a href="https://search.murata.co.jp/Ceramy/image/img/P02/JELF243A-9133.pdf">https://search.murata.co.jp/Ceramy/image/img/P02/JELF243A-9133.pdf</a>
Powertrain/Safety	—

### Appearance/Dimensions

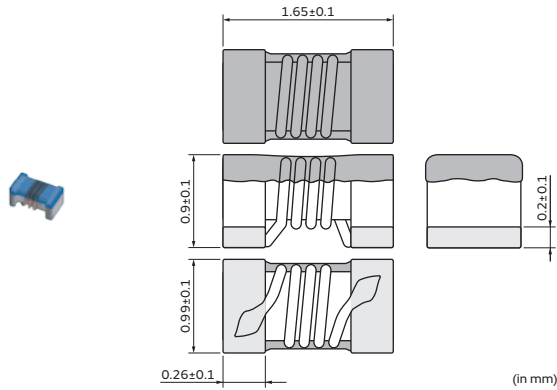

### Packaging

Code	Packaging	Minimum Quantity
D	ø180mm Paper Taping	4000
J	ø330mm Paper Taping	10000
B	Packing in Bulk	500

### Rated Value (□: packaging code)

Part Number		Inductance	Inductance Test Frequency	Q (min.)	Q Test Frequency	Rated Current	Max. of DC Resistance	S.R.F.* (min.)
Infotainment	Powertrain/Safety							
LQW18AN2N2C8Z□	—	2.2nH ±0.2nH	100MHz	24	250MHz	3200mA	0.018Ω	15000MHz
LQW18AN2N4C8Z□	—	2.4nH ±0.2nH	100MHz	18	250MHz	2400mA	0.026Ω	15000MHz
LQW18AN3N0C8Z□	—	3nH ±0.2nH	100MHz	13	250MHz	670mA	0.17Ω	15000MHz
LQW18AN3N9B8Z□	—	3.9nH ±0.1nH	100MHz	30	250MHz	2200mA	0.028Ω	10000MHz
LQW18AN3N9C8Z□	—	3.9nH ±0.2nH	100MHz	30	250MHz	2200mA	0.028Ω	10000MHz
LQW18AN3N9G8Z□	—	3.9nH ±2%	100MHz	30	250MHz	2200mA	0.028Ω	10000MHz
LQW18AN4N1B8Z□	—	4.1nH ±0.1nH	100MHz	30	250MHz	2200mA	0.028Ω	10000MHz
LQW18AN4N1C8Z□	—	4.1nH ±0.2nH	100MHz	30	250MHz	2200mA	0.028Ω	10000MHz
LQW18AN4N1G8Z□	—	4.1nH ±2%	100MHz	30	250MHz	2200mA	0.028Ω	10000MHz
LQW18AN4N2B8Z□	—	4.2nH ±0.1nH	100MHz	30	250MHz	2200mA	0.028Ω	10000MHz
LQW18AN4N2C8Z□	—	4.2nH ±0.2nH	100MHz	30	250MHz	2200mA	0.028Ω	10000MHz
LQW18AN4N2G8Z□	—	4.2nH ±2%	100MHz	30	250MHz	2200mA	0.028Ω	10000MHz
LQW18AN4N3B8Z□	—	4.3nH ±0.1nH	100MHz	35	250MHz	2100mA	0.036Ω	11600MHz
LQW18AN4N3C8Z□	—	4.3nH ±0.2nH	100MHz	35	250MHz	2100mA	0.036Ω	11600MHz
LQW18AN4N3G8Z□	—	4.3nH ±2%	100MHz	35	250MHz	2100mA	0.036Ω	11600MHz
LQW18AN4N7B8Z□	—	4.7nH ±0.1nH	100MHz	25	250MHz	1500mA	0.054Ω	10400MHz
LQW18AN4N7C8Z□	—	4.7nH ±0.2nH	100MHz	25	250MHz	1500mA	0.054Ω	10400MHz
LQW18AN4N7G8Z□	—	4.7nH ±2%	100MHz	25	250MHz	1500mA	0.054Ω	10400MHz
LQW18AN4N9B8Z□	—	4.9nH ±0.1nH	100MHz	23	250MHz	1200mA	0.081Ω	7300MHz
LQW18AN4N9C8Z□	—	4.9nH ±0.2nH	100MHz	23	250MHz	1200mA	0.081Ω	7300MHz
LQW18AN4N9G8Z□	—	4.9nH ±2%	100MHz	23	250MHz	1200mA	0.081Ω	7300MHz
LQW18AN5N6C8Z□	—	5.6nH ±0.2nH	100MHz	38	250MHz	1900mA	0.04Ω	6650MHz
LQW18AN5N6G8Z□	—	5.6nH ±2%	100MHz	38	250MHz	1900mA	0.04Ω	6650MHz
LQW18AN6N0C8Z□	—	6nH ±0.2nH	100MHz	40	250MHz	1900mA	0.04Ω	6650MHz
LQW18AN6N0G8Z□	—	6nH ±2%	100MHz	40	250MHz	1900mA	0.04Ω	6650MHz
LQW18AN6N5C8Z□	—	6.5nH ±0.2nH	100MHz	40	250MHz	1900mA	0.04Ω	6650MHz
LQW18AN6N5G8Z□	—	6.5nH ±2%	100MHz	40	250MHz	1900mA	0.04Ω	6650MHz

Operating temp.range (Self-temp.rise not included): -55 to 125°C

Only for reflow soldering

\*S.R.F.: Self Resonant Frequency

Please consider 'Notice (Rating).

Continued on the following page. ↗



Continued from the preceding page. ↘

Part Number		Inductance	Inductance Test Frequency	Q (min.)	Q Test Frequency	Rated Current	Max. of DC Resistance	S.R.F.* (min.)
Infotainment	Powertrain/Safety							
LQW18AN6N8C8Z□	—	6.8nH ±0.2nH	100MHz	40	250MHz	1900mA	0.04Ω	6650MHz
LQW18AN6N8G8Z□	—	6.8nH ±2%	100MHz	40	250MHz	1900mA	0.04Ω	6650MHz
LQW18AN7N2C8Z□	—	7.2nH ±0.2nH	100MHz	38	250MHz	1900mA	0.04Ω	6650MHz
LQW18AN7N2G8Z□	—	7.2nH ±2%	100MHz	38	250MHz	1900mA	0.04Ω	6650MHz
LQW18AN7N5C8Z□	—	7.5nH ±0.2nH	100MHz	35	250MHz	1500mA	0.048Ω	7000MHz
LQW18AN7N5G8Z□	—	7.5nH ±2%	100MHz	35	250MHz	1500mA	0.048Ω	7000MHz
LQW18AN8N2C8Z□	—	8.2nH ±0.2nH	100MHz	38	250MHz	1600mA	0.052Ω	4750MHz
LQW18AN8N2G8Z□	—	8.2nH ±2%	100MHz	38	250MHz	1600mA	0.052Ω	4750MHz
LQW18AN8N4C8Z□	—	8.4nH ±0.2nH	100MHz	38	250MHz	1600mA	0.052Ω	4750MHz
LQW18AN8N4G8Z□	—	8.4nH ±2%	100MHz	38	250MHz	1600mA	0.052Ω	4750MHz
LQW18AN8N7C8Z□	—	8.7nH ±0.2nH	100MHz	38	250MHz	1600mA	0.052Ω	4750MHz
LQW18AN8N7G8Z□	—	8.7nH ±2%	100MHz	38	250MHz	1600mA	0.052Ω	4750MHz
LQW18AN9N1C8Z□	—	9.1nH ±0.2nH	100MHz	38	250MHz	1600mA	0.052Ω	4750MHz
LQW18AN9N1G8Z□	—	9.1nH ±2%	100MHz	38	250MHz	1600mA	0.052Ω	4750MHz
LQW18AN9N5C8Z□	—	9.5nH ±0.2nH	100MHz	38	250MHz	1600mA	0.052Ω	4750MHz
LQW18AN9N5G8Z□	—	9.5nH ±2%	100MHz	38	250MHz	1600mA	0.052Ω	4750MHz
LQW18AN9N9C8Z□	—	9.9nH ±0.2nH	100MHz	38	250MHz	1600mA	0.052Ω	4750MHz
LQW18AN9N9G8Z□	—	9.9nH ±2%	100MHz	38	250MHz	1600mA	0.052Ω	4750MHz
LQW18AN10NG8Z□	—	10nH ±2%	100MHz	38	250MHz	1600mA	0.052Ω	4750MHz
LQW18AN10NJ8Z□	—	10nH ±5%	100MHz	38	250MHz	1600mA	0.052Ω	4750MHz
LQW18AN11NG8Z□	—	11nH ±2%	100MHz	40	250MHz	1600mA	0.052Ω	4750MHz
LQW18AN11NJ8Z□	—	11nH ±5%	100MHz	40	250MHz	1600mA	0.052Ω	4750MHz
LQW18AN12NG8Z□	—	12nH ±2%	100MHz	37	250MHz	1500mA	0.064Ω	5000MHz
LQW18AN12NJ8Z□	—	12nH ±5%	100MHz	37	250MHz	1500mA	0.064Ω	5000MHz
LQW18AN13NG8Z□	—	13nH ±2%	100MHz	37	250MHz	1500mA	0.064Ω	5000MHz
LQW18AN13NJ8Z□	—	13nH ±5%	100MHz	37	250MHz	1500mA	0.064Ω	5000MHz
LQW18AN15NG8Z□	—	15nH ±2%	100MHz	38	250MHz	1400mA	0.075Ω	4600MHz
LQW18AN15NJ8Z□	—	15nH ±5%	100MHz	38	250MHz	1400mA	0.075Ω	4600MHz
LQW18AN16NG8Z□	—	16nH ±2%	100MHz	40	250MHz	1400mA	0.075Ω	4600MHz
LQW18AN16NJ8Z□	—	16nH ±5%	100MHz	40	250MHz	1400mA	0.075Ω	4600MHz
LQW18AN17NG8Z□	—	17nH ±2%	100MHz	40	250MHz	1400mA	0.075Ω	4600MHz
LQW18AN17NJ8Z□	—	17nH ±5%	100MHz	40	250MHz	1400mA	0.075Ω	4600MHz
LQW18AN18NG8Z□	—	18nH ±2%	100MHz	40	250MHz	1400mA	0.075Ω	4600MHz
LQW18AN18NJ8Z□	—	18nH ±5%	100MHz	40	250MHz	1400mA	0.075Ω	4600MHz
LQW18AN19NG8Z□	—	19nH ±2%	100MHz	40	250MHz	1400mA	0.075Ω	4600MHz
LQW18AN19NJ8Z□	—	19nH ±5%	100MHz	40	250MHz	1400mA	0.075Ω	4600MHz
LQW18AN22NG8Z□	—	22nH ±2%	100MHz	40	250MHz	1300mA	0.086Ω	3450MHz
LQW18AN22NJ8Z□	—	22nH ±5%	100MHz	40	250MHz	1300mA	0.086Ω	3450MHz
LQW18AN23NG8Z□	—	23nH ±2%	100MHz	40	250MHz	1300mA	0.086Ω	3450MHz
LQW18AN23NJ8Z□	—	23nH ±5%	100MHz	40	250MHz	1300mA	0.086Ω	3450MHz
LQW18AN24NG8Z□	—	24nH ±2%	100MHz	40	250MHz	1300mA	0.086Ω	3450MHz
LQW18AN24NJ8Z□	—	24nH ±5%	100MHz	40	250MHz	1300mA	0.086Ω	3450MHz
LQW18AN25NG8Z□	—	25nH ±2%	100MHz	40	250MHz	1200mA	0.098Ω	3600MHz
LQW18AN25NJ8Z□	—	25nH ±5%	100MHz	40	250MHz	1200mA	0.098Ω	3600MHz
LQW18AN27NG8Z□	—	27nH ±2%	100MHz	40	250MHz	1200mA	0.098Ω	3600MHz
LQW18AN27NJ8Z□	—	27nH ±5%	100MHz	40	250MHz	1200mA	0.098Ω	3600MHz
LQW18AN28NG8Z□	—	28nH ±2%	100MHz	40	250MHz	1200mA	0.098Ω	3600MHz
LQW18AN28NJ8Z□	—	28nH ±5%	100MHz	40	250MHz	1200mA	0.098Ω	3600MHz
LQW18AN30NG8Z□	—	30nH ±2%	100MHz	40	250MHz	1100mA	0.12Ω	2880MHz
LQW18AN30NJ8Z□	—	30nH ±5%	100MHz	40	250MHz	1100mA	0.12Ω	2880MHz
LQW18AN31NG8Z□	—	31nH ±2%	100MHz	40	250MHz	1100mA	0.11Ω	3150MHz
LQW18AN31NJ8Z□	—	31nH ±5%	100MHz	40	250MHz	1100mA	0.11Ω	3150MHz

Operating temp.range (Self-temp.rise not included): -55 to 125°C

Only for reflow soldering

\*S.R.F.: Self Resonant Frequency

Please consider 'Notice (Rating).

Continued on the following page. ↗

Chip Ferrite Bead  
 Chip EMIFIL  
 Chip Common Mode Choke Coil  
 Block Type EMIFIL  
 Microchip Transformer (Ballun)  
 Inductors for Power Lines  
 Inductors for General Circuits  
 RF Inductors



Continued from the preceding page. ↘

Part Number		Inductance	Inductance Test Frequency	Q (min.)	Q Test Frequency	Rated Current	Max. of DC Resistance	S.R.F.* (min.)
Infotainment	Powertrain/Safety							
LQW18AN33NG8Z□	—	33nH ±2%	100MHz	40	250MHz	1100mA	0.11Ω	3150MHz
LQW18AN33NJ8Z□	—	33nH ±5%	100MHz	40	250MHz	1100mA	0.11Ω	3150MHz
LQW18AN34NG8Z□	—	34nH ±2%	100MHz	40	250MHz	1050mA	0.15Ω	3000MHz
LQW18AN34NJ8Z□	—	34nH ±5%	100MHz	40	250MHz	1050mA	0.15Ω	3000MHz
LQW18AN36NG8Z□	—	36nH ±2%	100MHz	37	250MHz	910mA	0.2Ω	3000MHz
LQW18AN36NJ8Z□	—	36nH ±5%	100MHz	37	250MHz	910mA	0.2Ω	3000MHz
LQW18AN37NG8Z□	—	37nH ±2%	100MHz	37	250MHz	910mA	0.2Ω	3000MHz
LQW18AN37NJ8Z□	—	37nH ±5%	100MHz	37	250MHz	910mA	0.2Ω	3000MHz
LQW18AN39NG8Z□	—	39nH ±2%	100MHz	40	250MHz	1000mA	0.16Ω	3280MHz
LQW18AN39NJ8Z□	—	39nH ±5%	100MHz	40	250MHz	1000mA	0.16Ω	3280MHz
LQW18AN41NG8Z□	—	41nH ±2%	100MHz	40	250MHz	1000mA	0.16Ω	3280MHz
LQW18AN41NJ8Z□	—	41nH ±5%	100MHz	40	250MHz	1000mA	0.16Ω	3280MHz
LQW18AN43NG8Z□	—	43nH ±2%	100MHz	40	250MHz	840mA	0.21Ω	2780MHz
LQW18AN43NJ8Z□	—	43nH ±5%	100MHz	40	250MHz	840mA	0.21Ω	2780MHz
LQW18AN44NG8Z□	—	44nH ±2%	100MHz	40	250MHz	840mA	0.21Ω	2780MHz
LQW18AN44NJ8Z□	—	44nH ±5%	100MHz	40	250MHz	840mA	0.21Ω	2780MHz
LQW18AN47NG8Z□	—	47nH ±2%	100MHz	32	200MHz	830mA	0.23Ω	2700MHz
LQW18AN47NJ8Z□	—	47nH ±5%	100MHz	32	200MHz	830mA	0.23Ω	2700MHz
LQW18AN48NG8Z□	—	48nH ±2%	100MHz	32	200MHz	830mA	0.23Ω	2700MHz
LQW18AN48NJ8Z□	—	48nH ±5%	100MHz	32	200MHz	830mA	0.23Ω	2700MHz
LQW18AN51NG8Z□	—	51nH ±2%	100MHz	32	200MHz	830mA	0.23Ω	2700MHz
LQW18AN51NJ8Z□	—	51nH ±5%	100MHz	32	200MHz	830mA	0.23Ω	2700MHz
LQW18AN52NG8Z□	—	52nH ±2%	100MHz	35	200MHz	750mA	0.27Ω	2750MHz
LQW18AN52NJ8Z□	—	52nH ±5%	100MHz	35	200MHz	750mA	0.27Ω	2750MHz
LQW18AN56NG8Z□	—	56nH ±2%	100MHz	38	200MHz	770mA	0.26Ω	2600MHz
LQW18AN56NJ8Z□	—	56nH ±5%	100MHz	38	200MHz	770mA	0.26Ω	2600MHz
LQW18AN58NG8Z□	—	58nH ±2%	100MHz	35	200MHz	700mA	0.3Ω	2400MHz
LQW18AN58NJ8Z□	—	58nH ±5%	100MHz	35	200MHz	700mA	0.3Ω	2400MHz
LQW18AN68NG8Z□	—	68nH ±2%	100MHz	37	200MHz	630mA	0.38Ω	2380MHz
LQW18AN68NJ8Z□	—	68nH ±5%	100MHz	37	200MHz	630mA	0.38Ω	2380MHz
LQW18AN69NG8Z□	—	69nH ±2%	100MHz	37	200MHz	630mA	0.38Ω	2380MHz
LQW18AN69NJ8Z□	—	69nH ±5%	100MHz	37	200MHz	630mA	0.38Ω	2380MHz
LQW18AN72NG8Z□	—	72nH ±2%	100MHz	34	150MHz	560mA	0.47Ω	2330MHz
LQW18AN72NJ8Z□	—	72nH ±5%	100MHz	34	150MHz	560mA	0.47Ω	2330MHz
LQW18AN73NG8Z□	—	73nH ±2%	100MHz	28	150MHz	590mA	0.41Ω	2280MHz
LQW18AN73NJ8Z□	—	73nH ±5%	100MHz	28	150MHz	590mA	0.41Ω	2280MHz
LQW18AN75NG8Z□	—	75nH ±2%	100MHz	28	150MHz	590mA	0.41Ω	2280MHz
LQW18AN75NJ8Z□	—	75nH ±5%	100MHz	28	150MHz	590mA	0.41Ω	2280MHz
LQW18AN78NG8Z□	—	78nH ±2%	100MHz	28	150MHz	590mA	0.41Ω	2280MHz
LQW18AN78NJ8Z□	—	78nH ±5%	100MHz	28	150MHz	590mA	0.41Ω	2280MHz
LQW18AN82NG8Z□	—	82nH ±2%	100MHz	34	150MHz	550mA	0.5Ω	2230MHz
LQW18AN82NJ8Z□	—	82nH ±5%	100MHz	34	150MHz	550mA	0.5Ω	2230MHz
LQW18AN83NG8Z□	—	83nH ±2%	100MHz	34	150MHz	550mA	0.5Ω	2230MHz
LQW18AN83NJ8Z□	—	83nH ±5%	100MHz	34	150MHz	550mA	0.5Ω	2230MHz
LQW18AN91NG8Z□	—	91nH ±2%	100MHz	33	150MHz	520mA	0.54Ω	1900MHz
LQW18AN91NJ8Z□	—	91nH ±5%	100MHz	33	150MHz	520mA	0.54Ω	1900MHz
LQW18AN94NG8Z□	—	94nH ±2%	100MHz	34	150MHz	490mA	0.63Ω	1750MHz
LQW18AN94NJ8Z□	—	94nH ±5%	100MHz	34	150MHz	490mA	0.63Ω	1750MHz
LQW18ANR10G8Z□	—	100nH ±2%	100MHz	34	150MHz	490mA	0.63Ω	1750MHz
LQW18ANR10J8Z□	—	100nH ±5%	100MHz	34	150MHz	490mA	0.63Ω	1750MHz
LQW18ANR11G8Z□	—	110nH ±2%	100MHz	32	150MHz	450mA	0.7Ω	1730MHz
LQW18ANR11J8Z□	—	110nH ±5%	100MHz	32	150MHz	450mA	0.7Ω	1730MHz

Operating temp.range (Self-temp.rise not included): -55 to 125°C

Only for reflow soldering

\*S.R.F.: Self Resonant Frequency

Please consider 'Notice (Rating).

Continued on the following page. ↗

Continued from the preceding page. ↘

Part Number		Inductance	Inductance Test Frequency	Q (min.)	Q Test Frequency	Rated Current	Max. of DC Resistance	S.R.F.* (min.)
Infotainment	Powertrain/Safety							
LQW18ANR12G8Z	—	120nH ±2%	100MHz	32	150MHz	450mA	0.72Ω	1650MHz
LQW18ANR12J8Z	—	120nH ±5%	100MHz	32	150MHz	450mA	0.72Ω	1650MHz
LQW18ANR15G8Z	—	150nH ±2%	100MHz	28	150MHz	420mA	0.87Ω	1580MHz
LQW18ANR15J8Z	—	150nH ±5%	100MHz	28	150MHz	420mA	0.87Ω	1580MHz
LQW18ANR18G8Z	—	180nH ±2%	100MHz	25	100MHz	310mA	1.65Ω	1380MHz
LQW18ANR18J8Z	—	180nH ±5%	100MHz	25	100MHz	310mA	1.65Ω	1380MHz
LQW18ANR20G8Z	—	200nH ±2%	100MHz	25	100MHz	290mA	1.74Ω	1350MHz
LQW18ANR20J8Z	—	200nH ±5%	100MHz	25	100MHz	290mA	1.74Ω	1350MHz
LQW18ANR21G8Z	—	210nH ±2%	100MHz	27	100MHz	280mA	1.98Ω	1330MHz
LQW18ANR21J8Z	—	210nH ±5%	100MHz	27	100MHz	280mA	1.98Ω	1330MHz
LQW18ANR22G8Z	—	220nH ±2%	100MHz	25	100MHz	280mA	2.08Ω	1330MHz
LQW18ANR22J8Z	—	220nH ±5%	100MHz	25	100MHz	280mA	2.08Ω	1330MHz
LQW18ANR25G8Z	—	250nH ±2%	100MHz	24	100MHz	250mA	2.28Ω	1330MHz
LQW18ANR25J8Z	—	250nH ±5%	100MHz	24	100MHz	250mA	2.28Ω	1330MHz
LQW18ANR27G8Z	—	270nH ±2%	100MHz	24	100MHz	260mA	2.42Ω	1250MHz
LQW18ANR27J8Z	—	270nH ±5%	100MHz	24	100MHz	260mA	2.42Ω	1250MHz
LQW18ANR30G8Z	—	300nH ±2%	100MHz	25	100MHz	220mA	3.12Ω	1200MHz
LQW18ANR30J8Z	—	300nH ±5%	100MHz	25	100MHz	220mA	3.12Ω	1200MHz
LQW18ANR33G8Z	—	330nH ±2%	100MHz	25	100MHz	190mA	3.84Ω	1100MHz
LQW18ANR33J8Z	—	330nH ±5%	100MHz	25	100MHz	190mA	3.84Ω	1100MHz
LQW18ANR36G8Z	—	360nH ±2%	100MHz	25	100MHz	190mA	3.98Ω	1050MHz
LQW18ANR36J8Z	—	360nH ±5%	100MHz	25	100MHz	190mA	3.98Ω	1050MHz
LQW18ANR39G8Z	—	390nH ±2%	100MHz	25	100MHz	190mA	4.23Ω	1100MHz
LQW18ANR39J8Z	—	390nH ±5%	100MHz	25	100MHz	190mA	4.23Ω	1100MHz

Operating temp.range (Self-temp.rise not included): -55 to 125°C

Only for reflow soldering

\*S.R.F: Self Resonant Frequency

Please consider 'Notice (Rating).

### Inductance-Frequency Characteristics (Typ.)

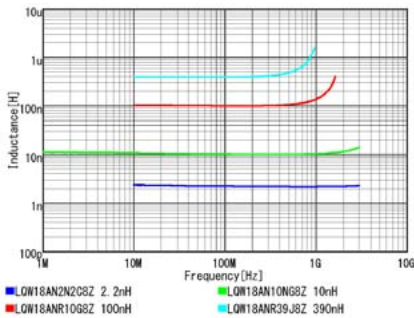

### Q-Frequency Characteristics (Typ.)

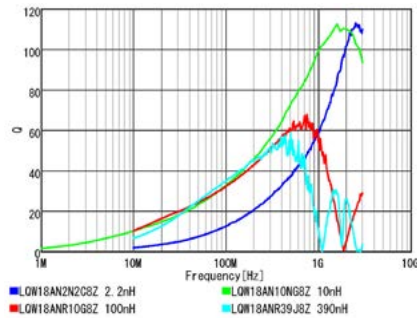

### Notice(Rating)

In operating temperatures exceeding +85°C, derating of current is necessary for this series.

Please apply the derating curve shown in the chart according to the operating temperature.

#### Derating of Rated Current

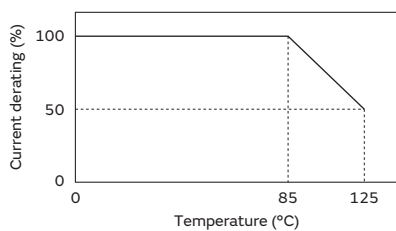

**RF Inductors**

# LQW18AS\_0Z Series 0603 (1608) inch (mm)

**Specifications Sheet (with cautions/mounting/packaging)**

Infotainment	<a href="https://search.murata.co.jp/Ceramy/image/img/P02/JELF243A-9139.pdf">https://search.murata.co.jp/Ceramy/image/img/P02/JELF243A-9139.pdf</a>
Powertrain/Safety	—

**Appearance/Dimensions**

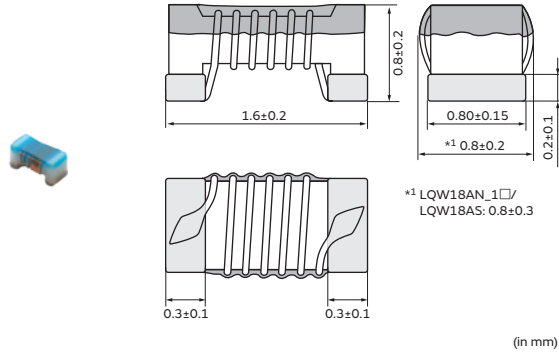

**Packaging**

Code	Packaging	Minimum Quantity
D	ø180mm Paper Taping	4000
J	ø330mm Paper Taping	10000
B	Packing in Bulk	500

**Rated Value (□: packaging code)**

Part Number		Inductance	Inductance Test Frequency	Q (min.)	Q Test Frequency	Rated Current	Max. of DC Resistance	S.R.F* (min.)
Infotainment	Powertrain/Safety							
LQW18AS1N6J0Z□	—	1.6nH ±5%	250MHz	24	250MHz	700mA	0.03Ω	12500MHz
LQW18AS1N8J0Z□	—	1.8nH ±5%	250MHz	16	250MHz	700mA	0.045Ω	12500MHz
LQW18AS3N3G0Z□	—	3.3nH ±2%	250MHz	35	250MHz	700mA	0.045Ω	5900MHz
LQW18AS3N3J0Z□	—	3.3nH ±5%	250MHz	35	250MHz	700mA	0.045Ω	5900MHz
LQW18AS3N6G0Z□	—	3.6nH ±2%	250MHz	22	250MHz	700mA	0.063Ω	5900MHz
LQW18AS3N6J0Z□	—	3.6nH ±5%	250MHz	22	250MHz	700mA	0.063Ω	5900MHz
LQW18AS3N9G0Z□	—	3.9nH ±2%	250MHz	22	250MHz	700mA	0.08Ω	6900MHz
LQW18AS3N9J0Z□	—	3.9nH ±5%	250MHz	22	250MHz	700mA	0.08Ω	6900MHz
LQW18AS4N3G0Z□	—	4.3nH ±2%	250MHz	22	250MHz	700mA	0.063Ω	5900MHz
LQW18AS4N3J0Z□	—	4.3nH ±5%	250MHz	22	250MHz	700mA	0.063Ω	5900MHz
LQW18AS4N7G0Z□	—	4.7nH ±2%	250MHz	20	250MHz	700mA	0.116Ω	5800MHz
LQW18AS4N7J0Z□	—	4.7nH ±5%	250MHz	20	250MHz	700mA	0.116Ω	5800MHz
LQW18AS5N1G0Z□	—	5.1nH ±2%	250MHz	20	250MHz	700mA	0.14Ω	5700MHz
LQW18AS5N1J0Z□	—	5.1nH ±5%	250MHz	20	250MHz	700mA	0.14Ω	5700MHz
LQW18AS5N6G0Z□	—	5.6nH ±2%	250MHz	26	250MHz	700mA	0.075Ω	4760MHz
LQW18AS5N6J0Z□	—	5.6nH ±5%	250MHz	26	250MHz	700mA	0.075Ω	4760MHz
LQW18AS6N8G0Z□	—	6.8nH ±2%	250MHz	27	250MHz	700mA	0.11Ω	5800MHz
LQW18AS6N8J0Z□	—	6.8nH ±5%	250MHz	27	250MHz	700mA	0.11Ω	5800MHz
LQW18AS7N5G0Z□	—	7.5nH ±2%	250MHz	28	250MHz	700mA	0.106Ω	4800MHz
LQW18AS7N5J0Z□	—	7.5nH ±5%	250MHz	28	250MHz	700mA	0.106Ω	4800MHz
LQW18AS8N2G0Z□	—	8.2nH ±2%	250MHz	30	250MHz	700mA	0.115Ω	4200MHz
LQW18AS8N2J0Z□	—	8.2nH ±5%	250MHz	30	250MHz	700mA	0.115Ω	4200MHz
LQW18AS8N7G0Z□	—	8.7nH ±2%	250MHz	28	250MHz	700mA	0.109Ω	4600MHz
LQW18AS8N7J0Z□	—	8.7nH ±5%	250MHz	28	250MHz	700mA	0.109Ω	4600MHz
LQW18AS9N5G0Z□	—	9.5nH ±2%	250MHz	28	250MHz	700mA	0.135Ω	5400MHz
LQW18AS9N5J0Z□	—	9.5nH ±5%	250MHz	28	250MHz	700mA	0.135Ω	5400MHz
LQW18AS10NG0Z□	—	10nH ±2%	250MHz	31	250MHz	700mA	0.13Ω	4800MHz
LQW18AS10NJ0Z□	—	10nH ±5%	250MHz	31	250MHz	700mA	0.13Ω	4800MHz

Operating temp.range (Self-temp.rise included): -40 to 125°C  
 Only for reflow soldering  
 \*S.R.F: Self Resonant Frequency

Continued on the following page. ↗

Continued from the preceding page. ↘

Part Number		Inductance	Inductance Test Frequency	Q (min.)	Q Test Frequency	Rated Current	Max. of DC Resistance	S.R.F.* (min.)
Infotainment	Powertrain/Safety							
LQW18AS11NG0Z□	—	11nH ±2%	250MHz	30	250MHz	700mA	0.086Ω	4000MHz
LQW18AS11NJ0Z□	—	11nH ±5%	250MHz	30	250MHz	700mA	0.086Ω	4000MHz
LQW18AS12NG0Z□	—	12nH ±2%	250MHz	35	250MHz	700mA	0.13Ω	4000MHz
LQW18AS12NJ0Z□	—	12nH ±5%	250MHz	35	250MHz	700mA	0.13Ω	4000MHz
LQW18AS15NG0Z□	—	15nH ±2%	250MHz	35	250MHz	700mA	0.17Ω	4000MHz
LQW18AS15NJ0Z□	—	15nH ±5%	250MHz	35	250MHz	700mA	0.17Ω	4000MHz
LQW18AS16NG0Z□	—	16nH ±2%	250MHz	34	250MHz	700mA	0.104Ω	3300MHz
LQW18AS16NJ0Z□	—	16nH ±5%	250MHz	34	250MHz	700mA	0.104Ω	3300MHz
LQW18AS18NG0Z□	—	18nH ±2%	250MHz	35	250MHz	700mA	0.17Ω	3100MHz
LQW18AS18NJ0Z□	—	18nH ±5%	250MHz	35	250MHz	700mA	0.17Ω	3100MHz
LQW18AS22NG0Z□	—	22nH ±2%	250MHz	38	250MHz	700mA	0.19Ω	3000MHz
LQW18AS22NJ0Z□	—	22nH ±5%	250MHz	38	250MHz	700mA	0.19Ω	3000MHz
LQW18AS23NG0Z□	—	23nH ±2%	250MHz	38	250MHz	700mA	0.19Ω	2850MHz
LQW18AS23NJ0Z□	—	23nH ±5%	250MHz	38	250MHz	700mA	0.19Ω	2850MHz
LQW18AS24NG0Z□	—	24nH ±2%	250MHz	36	250MHz	700mA	0.135Ω	2650MHz
LQW18AS24NJ0Z□	—	24nH ±5%	250MHz	36	250MHz	700mA	0.135Ω	2650MHz
LQW18AS27NG0Z□	—	27nH ±2%	250MHz	40	250MHz	600mA	0.22Ω	2800MHz
LQW18AS27NJ0Z□	—	27nH ±5%	250MHz	40	250MHz	600mA	0.22Ω	2800MHz
LQW18AS30NG0Z□	—	30nH ±2%	250MHz	37	250MHz	600mA	0.144Ω	2250MHz
LQW18AS30NJ0Z□	—	30nH ±5%	250MHz	37	250MHz	600mA	0.144Ω	2250MHz
LQW18AS33NG0Z□	—	33nH ±2%	250MHz	40	250MHz	600mA	0.22Ω	2300MHz
LQW18AS33NJ0Z□	—	33nH ±5%	250MHz	40	250MHz	600mA	0.22Ω	2300MHz
LQW18AS36NG0Z□	—	36nH ±2%	250MHz	37	250MHz	600mA	0.25Ω	2080MHz
LQW18AS36NJ0Z□	—	36nH ±5%	250MHz	37	250MHz	600mA	0.25Ω	2080MHz
LQW18AS39NG0Z□	—	39nH ±2%	250MHz	40	250MHz	600mA	0.25Ω	2200MHz
LQW18AS39NJ0Z□	—	39nH ±5%	250MHz	40	250MHz	600mA	0.25Ω	2200MHz
LQW18AS43NG0Z□	—	43nH ±2%	250MHz	38	250MHz	600mA	0.28Ω	2000MHz
LQW18AS43NJ0Z□	—	43nH ±5%	250MHz	38	250MHz	600mA	0.28Ω	2000MHz
LQW18AS47NG0Z□	—	47nH ±2%	200MHz	38	200MHz	600mA	0.28Ω	2000MHz
LQW18AS47NJ0Z□	—	47nH ±5%	200MHz	38	200MHz	600mA	0.28Ω	2000MHz
LQW18AS51NG0Z□	—	51nH ±2%	200MHz	35	200MHz	600mA	0.27Ω	1900MHz
LQW18AS51NJ0Z□	—	51nH ±5%	200MHz	35	200MHz	600mA	0.27Ω	1900MHz
LQW18AS56NG0Z□	—	56nH ±2%	200MHz	38	200MHz	600mA	0.31Ω	1900MHz
LQW18AS56NJ0Z□	—	56nH ±5%	200MHz	38	200MHz	600mA	0.31Ω	1900MHz
LQW18AS68NG0Z□	—	68nH ±2%	200MHz	37	200MHz	600mA	0.34Ω	1700MHz
LQW18AS68NJ0Z□	—	68nH ±5%	200MHz	37	200MHz	600mA	0.34Ω	1700MHz
LQW18AS72NG0Z□	—	72nH ±2%	150MHz	34	150MHz	400mA	0.49Ω	1700MHz
LQW18AS72NJ0Z□	—	72nH ±5%	150MHz	34	150MHz	400mA	0.49Ω	1700MHz
LQW18AS82NG0Z□	—	82nH ±2%	150MHz	34	150MHz	400mA	0.54Ω	1700MHz
LQW18AS82NJ0Z□	—	82nH ±5%	150MHz	34	150MHz	400mA	0.54Ω	1700MHz
LQW18ASR10G0Z□	—	100nH ±2%	150MHz	34	150MHz	400mA	0.58Ω	1400MHz
LQW18ASR10J0Z□	—	100nH ±5%	150MHz	34	150MHz	400mA	0.58Ω	1400MHz
LQW18ASR11G0Z□	—	110nH ±2%	150MHz	32	150MHz	300mA	0.61Ω	1350MHz
LQW18ASR11J0Z□	—	110nH ±5%	150MHz	32	150MHz	300mA	0.61Ω	1350MHz
LQW18ASR12G0Z□	—	120nH ±2%	150MHz	32	150MHz	300mA	0.65Ω	1300MHz
LQW18ASR12J0Z□	—	120nH ±5%	150MHz	32	150MHz	300mA	0.65Ω	1300MHz
LQW18ASR15G0Z□	—	150nH ±2%	150MHz	28	150MHz	280mA	0.92Ω	990MHz
LQW18ASR15J0Z□	—	150nH ±5%	150MHz	28	150MHz	280mA	0.92Ω	990MHz
LQW18ASR18G0Z□	—	180nH ±2%	100MHz	25	100MHz	240mA	1.25Ω	990MHz
LQW18ASR18J0Z□	—	180nH ±5%	100MHz	25	100MHz	240mA	1.25Ω	990MHz
LQW18ASR20G0Z□	—	200nH ±2%	100MHz	25	100MHz	200mA	1.98Ω	900MHz
LQW18ASR20J0Z□	—	200nH ±5%	100MHz	25	100MHz	200mA	1.98Ω	900MHz
LQW18ASR21G0Z□	—	210nH ±2%	100MHz	27	100MHz	200mA	2.06Ω	895MHz

Operating temp.range (Self-temp.rise included): -40 to 125°C

Only for reflow soldering

\*S.R.F.: Self Resonant Frequency

Continued on the following page. ↗

Continued from the preceding page. ↘

Part Number		Inductance	Inductance Test Frequency	Q (min.)	Q Test Frequency	Rated Current	Max. of DC Resistance	S.R.F* (min.)
Infotainment	Powertrain/Safety							
LQW18ASR21J0Z□	—	210nH ±5%	100MHz	27	100MHz	200mA	2.06Ω	895MHz
LQW18ASR22G0Z□	—	220nH ±2%	100MHz	25	100MHz	200mA	2.1Ω	900MHz
LQW18ASR22J0Z□	—	220nH ±5%	100MHz	25	100MHz	200mA	2.1Ω	900MHz
LQW18ASR25G0Z□	—	250nH ±2%	100MHz	25	100MHz	120mA	3.55Ω	822MHz
LQW18ASR25J0Z□	—	250nH ±5%	100MHz	25	100MHz	120mA	3.55Ω	822MHz
LQW18ASR27G0Z□	—	270nH ±2%	100MHz	24	100MHz	170mA	2.3Ω	900MHz
LQW18ASR27J0Z□	—	270nH ±5%	100MHz	24	100MHz	170mA	2.3Ω	900MHz
LQW18ASR33G0Z□	—	330nH ±2%	100MHz	25	100MHz	100mA	3.89Ω	900MHz
LQW18ASR33J0Z□	—	330nH ±5%	100MHz	25	100MHz	100mA	3.89Ω	900MHz
LQW18ASR39G0Z□	—	390nH ±2%	100MHz	25	100MHz	100mA	4.35Ω	900MHz
LQW18ASR39J0Z□	—	390nH ±5%	100MHz	25	100MHz	100mA	4.35Ω	900MHz

Operating temp.range (Self-temp.rise included): -40 to 125°C

Only for reflow soldering

\*S.R.F: Self Resonant Frequency

### Inductance-Frequency Characteristics (Typ.)

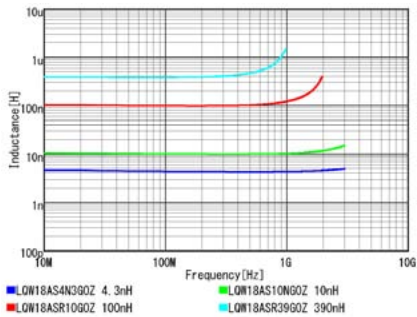

### Q-Frequency Characteristics (Typ.)

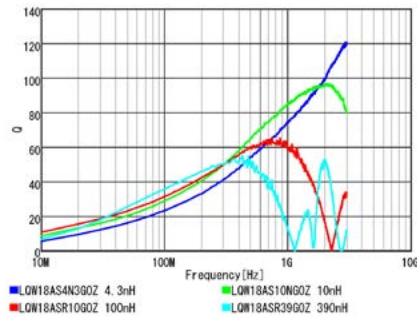



**RF Inductors**

# LQW15CN\_0Z Series 0402 (1005) inch (mm)

**Specifications Sheet (with cautions/mounting/packaging)**

Infotainment	<a href="https://search.murata.co.jp/Ceramy/image/img/P02/JELF243A-9141.pdf">https://search.murata.co.jp/Ceramy/image/img/P02/JELF243A-9141.pdf</a>
Powertrain/Safety	—

**Appearance/Dimensions**

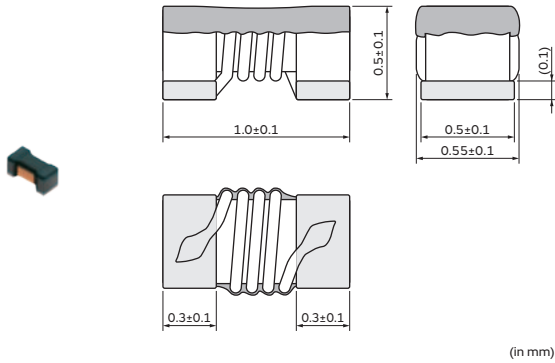

**Packaging**

Code	Packaging	Minimum Quantity
D	ø180mm Paper Taping	10000
B	Packing in Bulk	500

**Rated Value (□: packaging code)**

Part Number		Inductance	Inductance Test Frequency	Rated Current	Max. of DC Resistance	S.R.F* (min.)
Infotainment	Powertrain/Safety					
LQW15CN18NJ0Z□	—	18nH ±5%	100MHz	1400mA	0.046Ω	3000MHz
LQW15CN33NJ0Z□	—	33nH ±5%	100MHz	1300mA	0.065Ω	1800MHz
LQW15CN48NJ0Z□	—	48nH ±5%	100MHz	1100mA	0.078Ω	1400MHz
LQW15CN70NJ0Z□	—	70nH ±5%	100MHz	820mA	0.12Ω	1300MHz
LQW15CN96NJ0Z□	—	96nH ±5%	100MHz	730mA	0.16Ω	1100MHz
LQW15CNR13J0Z□	—	130nH ±5%	100MHz	640mA	0.23Ω	1000MHz
LQW15CNR16J0Z□	—	160nH ±5%	100MHz	480mA	0.33Ω	900MHz
LQW15CNR20J0Z□	—	200nH ±5%	100MHz	390mA	0.47Ω	800MHz

Operating temp.range (Self-temp.rise not included): -40 to 125°C  
 Class of Magnetic Shield: No Shield  
 Only for reflow soldering  
 \*S.R.F: Self Resonant Frequency

**Inductance-Frequency Characteristics (Typ.)**

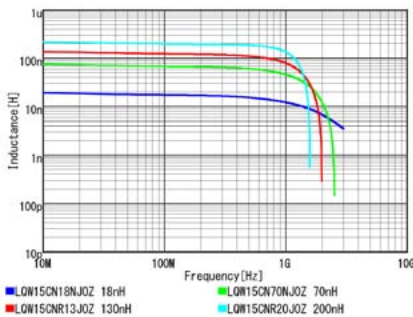

**Impedance-Frequency Characteristics (Typ.)**

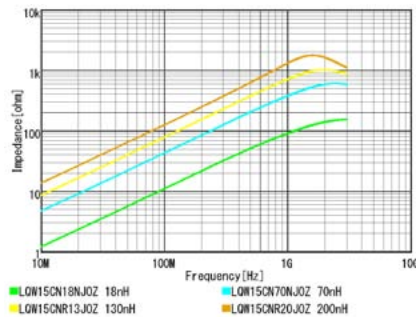

Continued on the following page. ↗

Continued from the preceding page. ↘

### Notice(Rating)

In operating temperatures exceeding +85°C, derating of current is necessary for this series.

Please apply the derating curve shown in the chart according to the operating temperature.

Derating of Rated Current

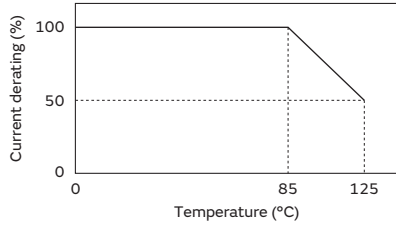



# RF Inductors

## LQW15CN\_1Z Series 0402 (1005) inch (mm)

### Specifications Sheet (with cautions/mounting/packaging)

Infotainment	<a href="https://search.murata.co.jp/Ceramy/image/img/P02/JELF243A-9142.pdf">https://search.murata.co.jp/Ceramy/image/img/P02/JELF243A-9142.pdf</a>
Powertrain/Safety	—

### Appearance/Dimensions

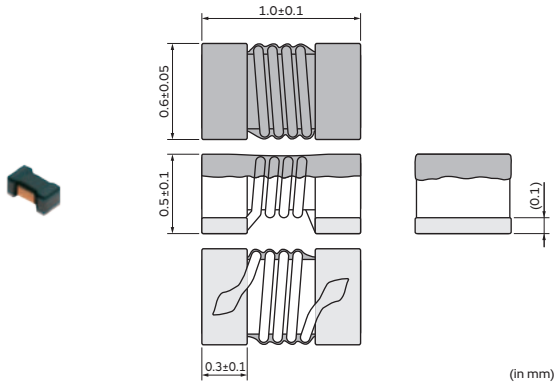

### Packaging

Code	Packaging	Minimum Quantity
D	ø180mm Paper Taping	10000
B	Packing in Bulk	500

### Rated Value (□: packaging code)

Part Number		Inductance	Inductance Test Frequency	Rated Current	Max. of DC Resistance	S.R.F* (min.)
Infotainment	Powertrain/Safety					
LQW15CN20NJ1Z□	—	20nH ±5%	100MHz	2200mA	0.028Ω	3000MHz
LQW15CN20NK1Z□	—	20nH ±10%	100MHz	2200mA	0.028Ω	3000MHz
LQW15CN34NJ1Z□	—	34nH ±5%	100MHz	1800mA	0.036Ω	2500MHz
LQW15CN34NK1Z□	—	34nH ±10%	100MHz	1800mA	0.036Ω	2500MHz
LQW15CN53NJ1Z□	—	53nH ±5%	100MHz	1300mA	0.06Ω	2000MHz
LQW15CN53NK1Z□	—	53nH ±10%	100MHz	1300mA	0.06Ω	2000MHz
LQW15CN77NJ1Z□	—	77nH ±5%	100MHz	1100mA	0.09Ω	2000MHz
LQW15CN77NK1Z□	—	77nH ±10%	100MHz	1100mA	0.09Ω	2000MHz
LQW15CNR11J1Z□	—	106nH ±5%	100MHz	850mA	0.144Ω	1500MHz
LQW15CNR11K1Z□	—	106nH ±10%	100MHz	850mA	0.144Ω	1500MHz
LQW15CNR14J1Z□	—	140nH ±5%	100MHz	650mA	0.216Ω	1000MHz
LQW15CNR14K1Z□	—	140nH ±10%	100MHz	650mA	0.216Ω	1000MHz
LQW15CNR18J1Z□	—	180nH ±5%	100MHz	560mA	0.312Ω	1000MHz
LQW15CNR18K1Z□	—	180nH ±10%	100MHz	560mA	0.312Ω	1000MHz
LQW15CNR22J1Z□	—	220nH ±5%	100MHz	450mA	0.47Ω	1400MHz
LQW15CNR22K1Z□	—	220nH ±10%	100MHz	450mA	0.47Ω	1400MHz
LQW15CNR27J1Z□	—	270nH ±5%	100MHz	420mA	0.52Ω	830MHz
LQW15CNR27K1Z□	—	270nH ±10%	100MHz	420mA	0.52Ω	830MHz
LQW15CNR33J1Z□	—	330nH ±5%	100MHz	390mA	0.56Ω	520MHz
LQW15CNR33K1Z□	—	330nH ±10%	100MHz	390mA	0.56Ω	520MHz
LQW15CNR39J1Z□	—	390nH ±5%	100MHz	370mA	0.62Ω	450MHz
LQW15CNR39K1Z□	—	390nH ±10%	100MHz	370mA	0.62Ω	450MHz
LQW15CNR42J1Z□	—	420nH ±5%	10MHz	370mA	0.62Ω	400MHz
LQW15CNR42K1Z□	—	420nH ±10%	10MHz	370mA	0.62Ω	400MHz
LQW15CNR47J1Z□	—	470nH ±5%	10MHz	350mA	0.66Ω	380MHz
LQW15CNR47K1Z□	—	470nH ±10%	10MHz	350mA	0.66Ω	380MHz
LQW15CNR56J1Z□	—	560nH ±5%	10MHz	300mA	0.71Ω	300MHz

Operating temp.range (Self-temp.rise not included): -40 to 125°C

Class of Magnetic Shield: No Shield

Only for reflow soldering

\*S.R.F: Self Resonant Frequency

Continued on the following page. ↗

Continued from the preceding page. ↘

Part Number		Inductance	Inductance Test Frequency	Rated Current	Max. of DC Resistance	S.R.F* (min.)
Infotainment	Powertrain/Safety					
LQW15CNR56K1Z□	—	560nH ±10%	10MHz	300mA	0.71Ω	300MHz

Operating temp.range (Self-temp.rise not included): -40 to 125°C

Class of Magnetic Shield: No Shield

Only for reflow soldering

\*S.R.F: Self Resonant Frequency

### Inductance-Frequency Characteristics (Typ.)

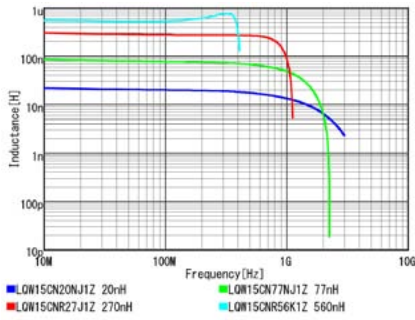

### Impedance-Frequency Characteristics (Typ.)

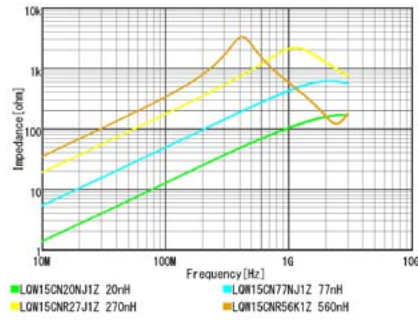

### Notice(Rating)

In operating temperatures exceeding +85°C, derating of current is necessary for this series.

Please apply the derating curve shown in the chart according to the operating temperature.

#### Derating of Rated Current

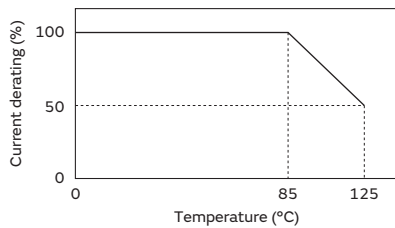

# RF Inductors

## LQW18CN\_0Z Series 0603 (1608) inch (mm)

### Specifications Sheet (with cautions/mounting/packaging)

Infotainment	<a href="https://search.murata.co.jp/Ceramy/image/img/P02/JELF243A-9145.pdf">https://search.murata.co.jp/Ceramy/image/img/P02/JELF243A-9145.pdf</a>
Powertrain/Safety	—

### Appearance/Dimensions

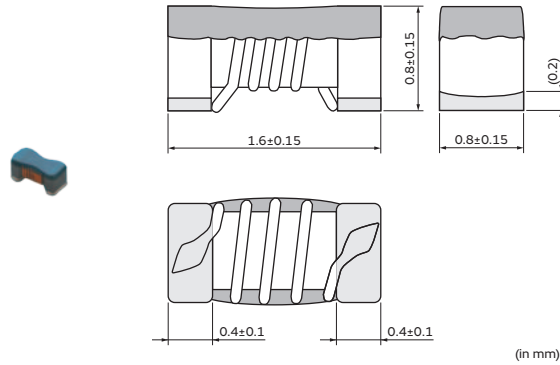

### Packaging

Code	Packaging	Minimum Quantity
D	ø180mm Paper Taping	4000
J	ø330mm Paper Taping	10000
B	Packing in Bulk	500

### Rated Value (□: packaging code)

Part Number		Inductance	Inductance Test Frequency	Rated Current	Max. of DC Resistance	S.R.F* (min.)
Infotainment	Powertrain/Safety					
LQW18CN4N9D0Z□	—	4.9nH ±0.5nH	10MHz	2600mA	0.015Ω	2300MHz
LQW18CN15NJ0Z□	—	15nH ±5%	10MHz	2200mA	0.025Ω	2000MHz
LQW18CN33NJ0Z□	—	33nH ±5%	10MHz	1700mA	0.035Ω	1800MHz
LQW18CN55NJ0Z□	—	55nH ±5%	10MHz	1500mA	0.045Ω	1600MHz
LQW18CN85NJ0Z□	—	85nH ±5%	10MHz	1400mA	0.06Ω	1380MHz
LQW18CNR10K0Z□	—	100nH ±10%	10MHz	1000mA	0.1Ω	1260MHz
LQW18CNR12J0Z□	—	120nH ±5%	10MHz	1100mA	0.085Ω	1200MHz
LQW18CNR16J0Z□	—	160nH ±5%	10MHz	1000mA	0.1Ω	900MHz
LQW18CNR21J0Z□	—	210nH ±5%	10MHz	800mA	0.15Ω	720MHz
LQW18CNR27J0Z□	—	270nH ±5%	10MHz	750mA	0.16Ω	660MHz
LQW18CNR33J0Z□	—	330nH ±5%	10MHz	630mA	0.25Ω	600MHz
LQW18CNR39J0Z□	—	390nH ±5%	10MHz	620mA	0.28Ω	570MHz
LQW18CNR47J0Z□	—	470nH ±5%	10MHz	500mA	0.45Ω	555MHz
LQW18CNR56J0Z□	—	560nH ±5%	10MHz	450mA	0.48Ω	540MHz
LQW18CNR65J0Z□	—	650nH ±5%	10MHz	430mA	0.52Ω	510MHz

Operating temp.range (Self-temp.rise not included): -40 to 125°C

Class of Magnetic Shield: No Shield

Only for reflow soldering

\*S.R.F: Self Resonant Frequency

### Inductance-Frequency Characteristics (Typ.)

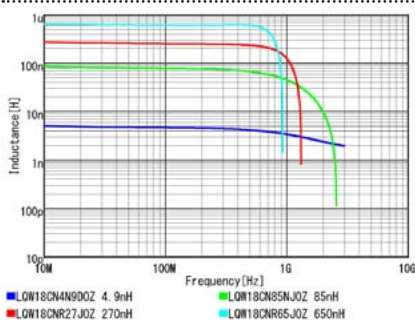

### Impedance-Frequency Characteristics (Typ.)

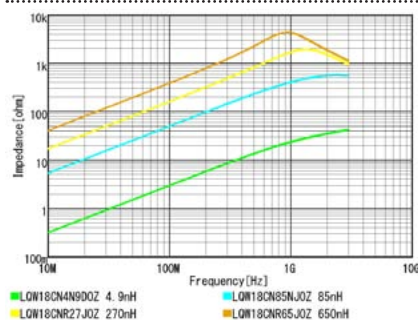

Continued on the following page. ↗

Continued from the preceding page. ↘

### Notice(Rating)

In operating temperatures exceeding +85°C, derating of current is necessary for this series.

Please apply the derating curve shown in the chart according to the operating temperature.

Derating of Rated Current

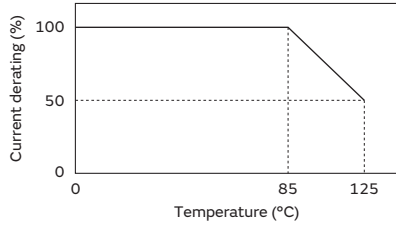

## RF Inductors ⚠Caution/Notice

### ⚠Caution

#### Rating

##### 1. About the Rated Current

Do not use products beyond the rated current as this may create excessive heat and deteriorate the insulation resistance.

For the usage of powertrain and safety be sure to provide an appropriate fail-safe function on your product to prevent a second damage that may be caused by the abnormal function or the failure of our product.

##### 2. About Excessive Surge Current

Surge current (pulse current or rush current) greater than the specified rated current applied to the product may cause a critical failure, such as an open circuit, burnout caused by excessive temperature rise.

Please contact us in advance in case of applying the surge current.

### Notice

#### Soldering and Mounting

LQG,LQP,LQW series are designed to be mounted by soldering. If you want to use other mounting method, for example, using a conductive adhesive, please consult us beforehand.

Also, if repeatedly subjected to temperature cycles or other thermal stress, due to the difference in the coefficient of thermal expansion with the mounting substrate, the solder (solder fillet part) in the mounting part may crack.

The occurrence of cracks due to thermal stress is affected by the size of the land where mounted, the solder volume, and the heat dissipation of the mounting substrate.

Carefully design it when a large change in ambient temperature is assumed.

Check the mounting condition before using. Using mounting conditions (nozzles, equipment conditions, etc.) that are not suitable for products may lead to pick up errors, misalignment, or damage to the product.

#### Storage and Operating Condition

##### 1. Operating Environment

Do not use products in chemical atmosphere such as chlorine gas, acid or sulfide gas.

##### 2. Storage Period

LQG series should be used within 6 months; the other products should be used within 12 months.

Check solderability if this period is exceeded.

##### 3. Storage Conditions

(1) Store products in a warehouse in compliance with the following conditions:

Temperature: -10 to +40 degrees C.

Humidity: 15 to 85% (relative humidity)

Do not subject products to rapid changes in temperature and humidity.

Do not store them in chemical atmosphere such as one containing sulfurous acid gas or alkaline gas.

This will prevent electrode oxidation, which causes poor solderability and possible corrosion of inductors.

(2) Do not store products in bulk packaging to prevent collision among inductors, which causes core chipping and wire breakage.

(3) Store products on pallets to protect from humidity, dust, etc.

(4) Avoid heat shock, vibration, direct sunlight, etc.

(5) Products should be stored under the airtight packaged condition. (LQG Series)

Continued on the following page. ↗

## RF Inductors ⚠Caution/Notice

Continued from the preceding page. ↘

### Handling

This item is designed to have sufficient strength, but handle with care to avoid chipping or breaking its ceramic structure.

#### LQW\_A/C series

- To prevent breaking the wire, avoid touching with sharp material, such as tweezers or the bristles of a cleaning brush, to the wire wound portion.
- To prevent breaking the core, avoid applying excessive mechanical shock to products mounted on the board.
- In some mounting machines, when picking up components, a support pin pushes the components up from the bottom of the base tape. In this case, please remove the support pin. The support pin may damage the components and break the wire.
- In rare cases, the laser recognition cannot recognize this component. Please contact us when you use laser recognition. (There is no problem with the permeation and reflection type.) (LQW15A Series only)

#### <Transportation>

Do not apply excessive vibration or mechanical shock to products.

#### <Resin Coating>

When coating products with resin, the relatively high resin curing stress may change inductance values. For exterior coating, select resin carefully so that electrical and mechanical performance of the product is not affected. Prior to use, please evaluate reliability with the product mounted in your application set.

#### (LQW series)

An open circuit issue may occur by mechanical stress caused by the resin, amount/cured shape of resin, or operating conditions, etc. Some resins containing impurities or chloride may possibly generate chlorine by hydrolysis under some operating conditions, causing corrosion of the inductor wire and leading to an open circuit.

#### (LQP series)

When products are coated with resin, please contact us in advance.

### About Corrosive Gases

Please refrain from use since contact with environments with corrosive gases (sulfur gas [hydrogen sulfide, sulfur dioxide, etc.], chlorine, ammonia, etc.) or oils (cutting oil, silicone oil, etc.) that have come into contact with the previously stated corrosive gas environment will result in

#### <Handling of a Substrate>

After mounting products on a substrate, do not apply any stress to the product caused by bending or twisting the substrate when cropping the substrate, inserting and removing a connector from the substrate, or tightening a screw to the substrate.

Excessive mechanical stress may cause cracking in the Product.

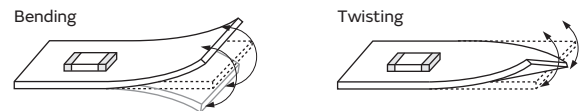

#### Substrate Restriction (LQP Series)

- Don't mount on FPC (Flexible printed circuits)
- When components are mounted on substrate of under 6-layers, please contact us in advance. To mount components on FPC or substrate of under 6-layers may cause of cracking issue by stress.

(1) There is a possibility of chip cracking caused by PCB expansion/contraction with heat, because stress on a chip is different depending on PCB material and structure.

When the thermal expansion coefficient greatly differs between the board used for mounting and the chip, it will cause cracking of the chip due to the thermal expansion and contraction.

The chip is assumed to be mounted on the PCB of glass-epoxy material, and we don't test with other PCB material which has different thermal expansion coefficient from Glass-epoxy.

When other PCB materials are considered, please be sure to evaluate by yourself.

(2) After mounting products on a substrate, do not apply any stress to the product caused by bending or twisting to the substrate when cropping the substrate, inserting and removing a connector from the substrate or tightening screw to the substrate. Excessive mechanical stress may cause cracking in the product.

In case of the mounting on flexible PCB, there is a possibility of chip cracking caused by mechanical stress even from small bending or twisting. When the flexible PCB is considered, please be sure to evaluate by yourself.

deterioration of product quality or an open from deterioration due to corrosion of product electrode, etc. We will not bear any responsibility for use under these environments.

Continued on the following page. ↗

## RF Inductors ⚠Caution/Notice

Continued from the preceding page. ↘

### Cleaning

The following conditions should be observed when cleaning chip inductors (chip coils):

- (1) Cleaning Temperature: 60°C max. (40°C max. for alcohol cleaning agents)
- (2) Ultrasonic
  - Output: 20W/l max.
  - Duration: 5 minutes max.
  - Frequency: 28 to 40kHz
  - Care should be taken not to cause resonance of the PCB and mounted products.

#### (3) Cleaning agent

The following cleaning agents have been tested on individual components. Evaluation in complete assembly should be done prior to production.

- (a) Alcohol cleaning agents
  - Isopropyl alcohol (IPA)
- (b) Aqueous cleaning agents
  - Pine Alpha ST-100S

#### (4) Ensure that flux residue is completely removed.

Component should be thoroughly dried after aqueous agents have been removed with deionized water.

For additional cleaning methods, please contact Murata.

### Measuring Method

Measuring Method of Inductance/Q

1. Residual elements and stray elements of test fixtures can be described by F-parameter as shown in the following:

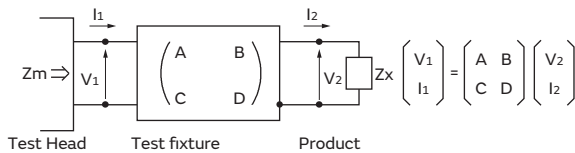

2. The impedance of chip Inductors (chip coils)  $Z_x$  and measured value  $Z_m$  can be described by input/output current/voltage.

$$Z_m = \frac{V_1}{I_1}, \quad Z_x = \frac{V_2}{I_2}$$

3. Thus, the relation between  $Z_x$  and  $Z_m$  is shown in the following:

$$Z_x = \alpha \frac{Z_m - \beta}{1 - Z_m \Gamma} \quad \text{where, } \alpha = D / A = 1$$

$$\beta = B / D = Z_{sm} - (1 - Y_{om} Z_{sm}) Z_{ss}$$

$$\Gamma = C / A = Y_{om}$$

$Z_{sm}$ : measured impedance of short chip  
 $Z_{ss}$ : residual impedance of short chip\*  
 $Y_{om}$ : measured admittance when opening the fixture

\*Residual inductance of short chip

Residual Inductance	Series
0nH	LQG15H, LQG18HH
0.480nH	LQP03TN
0.556nH	LQG15W, LQW15A/C
0.771nH	LQH31H, LQW18AN/C

4.  $L_x$  and  $Q_x$  should be calculated with the following equation.

$$L_x = \frac{\text{Im}(Z_x)}{2\pi f}, \quad Q_x = \frac{\text{Im}(Z_x)}{\text{Re}(Z_x)}$$

$L_x$ : Inductance of chip Inductors (chip coils)  
 $Q_x$ : Q of chip Inductors (chip coils)  
 $f$ : Measuring frequency

Please contact us for LQW18AS\_0Z because residual inductance value is defined by each part number.



# Part Number Quick Reference

## EMI Suppression Filters (for DC)

### Chip Ferrite Bead

BLE18PS	117
BLE18PS (150°C available)	118
BLE32PN	119
BLM03AG	10
BLM03AX	9
BLM03BB	12
BLM03BC	13
BLM03BD	14
BLM03EB	19
BLM03HB	15
BLM03HD	16
BLM03HG	18
BLM03PG	6
BLM03PX	7
BLM15AG	30
BLM15AX	28
BLM15BA	31
BLM15BB	32
BLM15BC	34
BLM15BD	35
BLM15BX	37
BLM15EG	46
BLM15GA	48
BLM15GG	49
BLM15HB	39
BLM15HD	40
BLM15HD (150°C available)	41
BLM15HG	43
BLM15HG (150°C available)	44
BLM15PD	21
BLM15PE	23
BLM15PG	25
BLM15PX	26
BLM18AG	66
BLM18AG (150°C available)	68
BLM18AG (for conductive glue mounting)	70
BLM18BA	72
BLM18BB	73

BLM18BD	75
BLM18BD (150°C available)	77
BLM18DN	80
BLM18EG	87
BLM18GG	89
BLM18HB	82
BLM18HD	83
BLM18HE	84
BLM18HG	86
BLM18KG	57
BLM18KG (150°C available)	59
BLM18KG (for conductive glue mounting)	62
BLM18KN (175°C available)	64
BLM18PG	50
BLM18SG	52
BLM18SN	54
BLM18SP	55
BLM21AG	99
BLM21AG (150°C available)	101
BLM21BB	103
BLM21BD	105
BLM21PG	90
BLM21PG (150°C available)	92
BLM21SN	94
BLM21SP	95
BLM21SP (150°C available)	97
BLM31AJ	114
BLM31KN	109
BLM31KN (150°C available)	111
BLM31PG	107
BLM31SN	113
BLM41PG	115

NFZ18SM_SZ10	128
NFZ2MSD_SZ10	130
NFZ32BW_HZ10	132
NFZ32BW_HZ11	135
NFZ5BBW_LZ10	137

### Chip Common Mode Choke Coil

DLM11SN_HZ2	146
DLW21PH_XQ2	150
DLW21SH_XQ2	149
DLW21SZ_HQ2	147
DLW21SZ_XQ2	148
DLW31SH_SQ2	151
DLW32MH_XK2	152
DLW32MH_XT2	153
DLW32SH_XF2	154
DLW43MH_XK2	155
DLW43SH_XK2	156
DLW5ATH_MQ2	157
DLW5ATH_TQ2	159
DLW5ATZ_MQ2	157
DLW5ATZ_TQ2	159
DLW5BSZ_TQ2	161
DLW5BTH_TQ2	162
DLW5BTZ_TQ2	162
PLT10HH_PN	166
PLT5BPH_SN	164
UCMH	168

### Block Type EMIFIL

BNX012	178
BNX02□	174

### Microchip Transformer (Balun)

DXW21B	183
--------	-----

### Chip EMIFIL

BLF03JD	140
NFE31ZT	124
NFE61HT	125
NFL18ZT	126
NFZ15SF_SZ10	127

## Chip Inductors

### Inductors for Power Lines

DEM8045C_Z	230
DFE201612P_D	191
DFE252012P_D	195
DFE2HCAH_JO	197
DFE2MCAH_JO	193
DFE322520F_D	199
LQH2HPZ_DR	203
LQH2HPZ_GR	205
LQH2HPZ_JR	207
LQH2MPZ_GR	201
LQH32CH_23	221
LQH32CH_33	222
LQH32CH_53	223
LQH32DZ_23	219
LQH32DZ_53	220
LQH32PH_NO	215
LQH32PH_NC	217
LQH32PZ_NO	215
LQH32PZ_NC	217
LQH3NPH_ME	213
LQH3NPZ_GR	209
LQH3NPZ_JR	211
LQH3NPZ_ME	213
LQH43PH_26	224
LQH43PZ_26	224
LQH44PH_PR	226

LQH5BPH_TO	228
LQH5BPZ_TO	228
LQM18DH_70	240
LQM18DZ_70	240
LQM18PH_FR	236
LQM18PZ_CH	232
LQM18PZ_DH	234
LQM18PZ_FH	238
LQM21DH_70	250
LQM21PH_G0	244
LQM21PH_GC	246
LQM21PZ_C0	242
LQM21PZ_G0	244
LQM21PZ_GC	246
LQM21PZ_GR	248
LQM2HPZ_E0	256
LQM2HPZ_G0	258
LQM2HPZ_GC	260
LQM2HPZ_GS	262
LQM2HPZ_JO	264
LQM2MPZ_G0	252
LQM2MPZ_JH	254
LQW21FT_OH	266
LQW32FT_OH	268

FSDVA	283
HEAWS	281
LQH31HZ_03	275
LQH32NH_23	276
LQH32NZ_23	276
LQH43NH_03	278
LQH43NZ_03	278

### RF Inductors

LQG15HH_02	289
LQG15HZ_02	289
LQG15WZ_02	293
LQG15WH_02	293
LQG18HH_00	299
LQP03TN_Z2	301
LQW15AN_OZ	305
LQW15AN_1Z	311
LQW15AN_8Z	313
LQW15CN_OZ	332
LQW15CN_1Z	334
LQW18AN_OZ	320
LQW18AN_1Z	323
LQW18AN_8Z	325
LQW18AS_OZ	329
LQW18CN_OZ	336

### Inductors for General Circuits

5CCEG	282
-------	-----

# Global Locations

For details please visit [www.murata.com](http://www.murata.com)



## ⚠ Note

### 1 Export Control

#### For customers outside Japan:

Murata requests customers to ensure that no Murata products are used or sold, through any channels, for use in the design, development, production, utilization, maintenance or operation of, or otherwise contribution to Weapons of Mass Destruction (nuclear, chemical or biological weapons or missiles), conventional weapons, or items specially designed for them.

#### For customers in Japan:

For products which are controlled items subject to the "Foreign Exchange and Foreign Trade Law" of Japan, the export license specified by the law is required for export.

2 Please contact our sales representatives or product engineers before using the products in this catalog for the applications listed below, which require especially high reliability for the prevention of defects which might directly damage a third party's life, body or property, or when one of our products is intended for use in applications other than those specified in this catalog.

- ① Aircraft equipment
- ② Aerospace equipment
- ③ Undersea equipment
- ④ Power plant equipment
- ⑤ Medical equipment
- ⑥ Transportation equipment (vehicles, trains, ships, etc.)
- ⑦ Traffic signal equipment
- ⑧ Disaster prevention / crime prevention equipment
- ⑨ Data-processing equipment
- ⑩ Application of similar complexity and/or reliability requirements to the applications listed above

3 Product specifications in this catalog are as of May 2021. They are subject to change or our products in it may be discontinued without advance notice. Please check with our sales representatives or product engineers before ordering. If there are any questions, please contact our sales representatives or product engineers.

4 Please read rating and ⚠CAUTION (for storage, operating, rating, soldering, mounting and handling) in this catalog to prevent smoking and/or burning, etc.

5 This catalog has only typical specifications. Therefore, please approve our product specifications or transact the approval sheet for product specifications before ordering.

6 Please note that unless otherwise specified, we shall assume no responsibility whatsoever for any conflict or dispute that may occur in connection with the effect of our and/or a third party's intellectual property rights and other related rights in consideration of your use of our products and/or information described or contained in our catalogs. In this connection, no representation shall be made to the effect that any third parties are authorized to use the rights mentioned above under licenses without our consent.

7 No ozone depleting substances (ODS) under the Montreal Protocol are used in our manufacturing process.

Murata Manufacturing Co., Ltd.

[www.murata.com](http://www.murata.com)

**muRata**  
INNOVATOR IN ELECTRONICS